

CATÁLOGO GENERAL
2022



INDEX[®]
A PERFECT FIXING

A
PERFECT
FIXING

CATÁLOGO GENERAL 2022

 02
PRESENTACIÓN

 20
NOVEDADES

 22
ÍNDICE

 39
FIJACIONES METÁLICAS

 73
FIJACIONES QUÍMICAS

 89
FIJACIONES PLÁSTICAS

 101
FIJACIONES Y ACCESORIOS PARA SISTEMAS DE AISLAMIENTO TÉRMICO (SATE)

 105
FIJACIONES PARA MATERIALES HUECOS

 111
REMACHES

 117
ACCESORIOS PARA CABLE CADENA Y CERCADOS

 123
FIJACIONES Y ACCESORIOS PARA PLACA DE YESO

 131
FIJACIÓN DIRECTA

 141
TORNILLOS PARA CUBIERTAS Y FACHADAS

 149
TORNILLOS BROCA, ROSCA CHAPA Y PVC

 165
TORNILLOS PARA MADERA

 187
PUNTAS, ALCAYATAS Y HEMBRILLAS

 199
CONECTORES DE MADERA

 207
TORNILLERÍA NORMALIZADA

 225
BROCAS, PUNTAS Y ACCESORIOS

 231
ABRAZADERAS METÁLICAS PESADAS

 247
ABRAZADERAS METÁLICAS LIGERAS

 263
SISTEMAS PROTECCIÓN CONTRA INCENDIOS

 267
SOPORTES DE CANALÓN

 269
ABRAZADERAS PLÁSTICAS

 283
PERFILERÍA Y SOPORTACIÓN

 295
SISTEMAS DE INSTALACIÓN Y FIJACIONES PARA PANELES FOTOVOLTAICOS

 305
SISTEMAS DE FIJACIÓN RÁPIDA EN VIGA

 309
VARILLA ROSCADA Y ACCESORIOS DE FIJACIÓN

 317
FIJACIÓN SANITARIOS Y CLIMATIZACIÓN

 323
EASYKITS

 329
GAMA INOX

 353
CARACTERÍSTICAS TÉCNICAS

 420
ÍNDICE POR REFERENCIAS

INDEX[®]
A PERFECT FIXING



UNA FIJACIÓN PERFECTA
PARA TU NEGOCIO





En **INDEX®** somos fabricantes y proveedores industriales de sistemas de fijación, ofreciendo soluciones globales adaptadas a las necesidades de tu actividad.

PERO SOMOS MUCHO MÁS QUE ESO. SOMOS UN NUMEROSO EQUIPO HUMANO EN CONTINUA INVESTIGACIÓN, DESARROLLO E INNOVACIÓN Y, POR QUÉ NO DECIRLO, UN POCO OBSESIONADOS CON NUESTRO OBJETIVO: CONSEGUIR UNA FIJACIÓN PERFECTA.

Sea cual sea el tamaño de tu negocio, en **INDEX®** buscaremos una fijación perfecta para el mismo.



**¿POR QUÉ INDEX[®]
ES UNA FIJACIÓN
PERFECTA PARA
TU NEGOCIO?**

En **INDEX[®]** creemos que no hay imposibles cuando se trata de perseguir la perfección. Por eso realizamos continuas inversiones en nuevos productos, homologaciones, procesos productivos y medios tecnológicos para responder a todas las demandas del mercado.

Estas son sólo algunas de
las razones por las que
**INDEX[®] MARCA
LA DIFERENCIA**

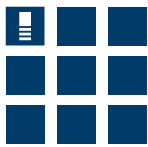

DISPONIBILIDAD Y AMPLIA GAMA DE PRODUCTO

Más de 10.000 referencias con stock permanente garantizado.



TRABAJAMOS CON EL CANAL

Vendemos a través del canal distribuidor, lo que nos permite conocer el mercado de primera mano.



SOMOS EXPERTOS FABRICANTES

Más de 30 años fabricando sistemas de fijación, nos permite garantizar la máxima calidad en nuestros productos, el mejor servicio y un coste global competitivo.



CALIDAD CERTIFICADA

Contamos con los certificados y homologaciones más importantes, verificando que todos nuestros productos cumplan los más altos estándares de calidad.



PRESENCIA INTERNACIONAL

Somos una empresa global, con ventas en más de 90 países en los 5 continentes y con instalaciones en España, China y México.



SERVICIOS DE INGENIERÍA Y SOPORTE TÉCNICO

Apoyamos a nuestros clientes y a sus clientes en el diseño y cálculo de fijaciones, visitas a obra conjunta y formaciones técnicas sobre temas relacionados con el mundo de la fijación.



SERVICIO DE CALIDAD AL CLIENTE

Nuestros clientes son el centro de todo lo que hacemos. Disponemos de un equipo de más de 300 personas a su servicio.



INDEX SPACE ESTUDIO

Sea cual sea el negocio de nuestros clientes, tenemos una solución expositiva para el mismo.



DISPONIBILIDAD Y AMPLIA GAMA DE PRODUCTO

Somos especialistas en anclajes, tornillos, abrazaderas, sistemas de instalación... Disponemos de la más amplia gama de producto, con más de 10.000 referencias, con un stock permanente garantizado en nuestras instalaciones de España, China y México (más de 45.000m²).



**TENEMOS TODO
LO QUE PUEDES
NECESITAR A NIVEL
DE FIJACIÓN,
APOSTANDO POR
LA INCORPORACIÓN
CONSTANTE DE
NUEVOS PRODUCTOS:
anclajes, tornillos,
abrazaderas, sistemas
de instalación...**





SOMOS EXPERTOS FABRICANTES

Tenemos el control total del proceso productivo, que junto con nuestra experiencia de más de 30 años como fabricantes de sistemas de fijación, nos permite garantizarte la máxima calidad en nuestros productos, el mejor servicio y un coste global competitivo.



**MÁS DE 30 AÑOS
DE EXPERIENCIA**

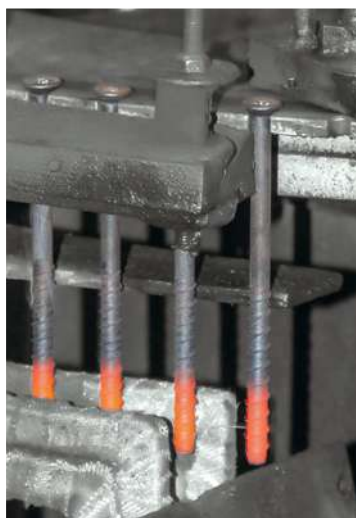



PRESENCIA INTERNACIONAL

Vendemos en más de 90 países en los 5 continentes y nuestros productos están presentes en los proyectos de construcción más importantes a nivel internacional.





SERVICIO DE CALIDAD AL CLIENTE

Para garantizarte una fijación perfecta, contamos con un equipo de más de 300 personas a tu servicio y unas instalaciones de más de 45.000 m² y 22.000 pallets de capacidad, garantizando un plazo de entrega de 24-48 horas y una respuesta rápida a cualquier tipo de necesidad que puedas tener.



**MÁS DE 300 PERSONAS
A TU SERVICIO**





TRABAJAMOS CON EL CANAL

En **INDEX®**, vendemos a través del canal distribuidor, lo que nos permite estar cerca de nuestros clientes. En este sentido, y para darte el mejor servicio, estamos presente en los canales más importantes, con gamas de productos adecuadas a cada uno de ellos y profesionales altamente cualificados para brindarte el mejor servicio.





CALIDAD CERTIFICADA

Nuestra obsesión por la perfección nos lleva a ampliar continuamente nuestras Certificaciones y Homologaciones de laboratorios independientes y de los principales organismos oficiales, que garantizan la máxima calidad tanto en productos como en sistemas de gestión.

HOMOLOGACIONES



Evaluación Técnica Europea



Conformidad Europea



Homologación Sísmica



ICC-ES®



Resistencia al fuego



Underwriters Laboratories



Homologación FM



Leadership in Energy and Environmental Design



Emisiones VOC reducidas



Water Regulations Advisory Scheme

CERTIFICACIONES



Sistema de Gestión
ISO 9001:2015

www.tuv.com
ID 0091006720



NUESTRO COMPROMISO DE CALIDAD A TRAVÉS DE LA CERTIFICACIÓN TÜV CERT GARANTIZA QUE INDEX® HA IMPLEMENTADO UN SISTEMA DE GESTIÓN SEGÚN LA NORMA ISO 9001:2015



SERVICIOS DE INGENIERÍA Y SOPORTE TÉCNICO

Te ofrecemos un completo asesoramiento técnico a través de un equipo de ingenieros especializados. Disponemos de un servicio S.A.T, software propio especializado y la más completa documentación técnica.

Y lo más importante, un equipo que te apoyará en el diseño, cálculo de fijaciones, visita a obra y formaciones técnicas sobre todo lo relacionado con el mundo de la fijación.

SERVICIO S.A.T. Y ASESORAMIENTO TÉCNICO



FORMACIÓN TÉCNICA



SERVICIOS DE INGENIERÍA Y REALIZACIÓN DE CÁLCULOS

SOFTWARE ESPECIALIZADO



INDEXcal



INDEXwood

Tenemos el software que mejor se adapta a tus necesidades en cada caso concreto.

INDEXcal, software para el cálculo de anclajes y diseño de soluciones estructurales.

INDEXwood, software para el diseño y cálculo de conexiones de estructuras de madera.

INDEXmor, herramienta online que permite calcular el número de cartuchos químicos necesarios en función de diferentes parámetros.

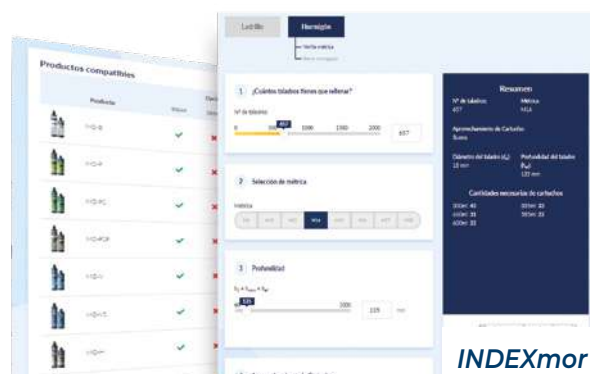

INDEXmor



AMPLIA DOCUMENTACIÓN TÉCNICA DISPONIBLE

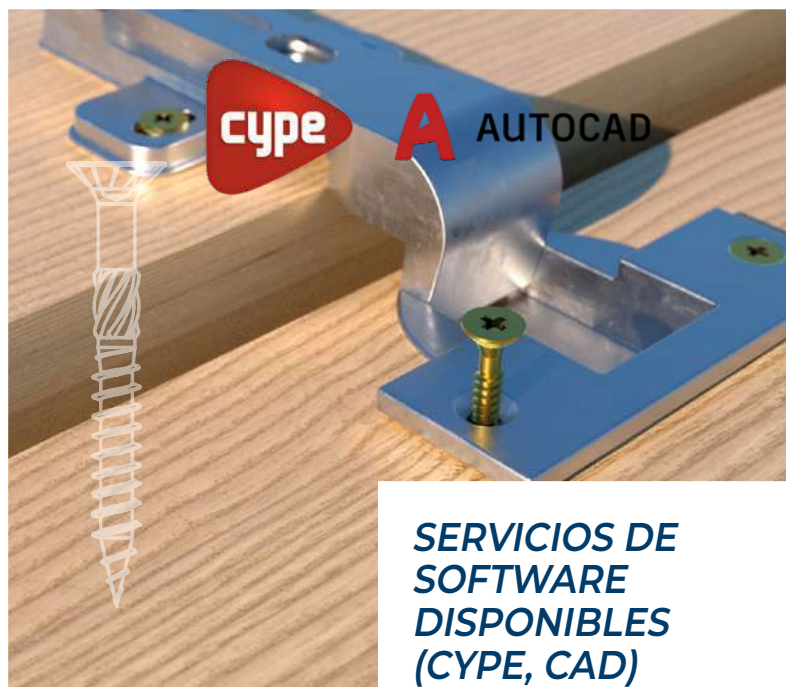

SERVICIOS DE SOFTWARE DISPONIBLES (CYPE, CAD)



INDEX Space Studio es el servicio de INDEX® dedicado al diseño personalizado de expositores y su implantación en los clientes.

Se trata de un servicio único en el mercado, 100% personalizable según las necesidades específicas del cliente (producto, formato de packaging, rotación y/o tipología de negocio), con el objetivo de rentabilizar al máximo el espacio de venta.





VENTAJAS Y CARACTERÍSTICAS

- **PERSONALIZABLE.** Servicio de implantaciones adaptadas a las necesidades de cada negocio.
- **IMPLANTACIONES 100% OPTIMIZADAS.** El sistema está ideado para obtener el máximo aprovechamiento del espacio en el punto de venta.
- **MÚLTIPLES SOLUCIONES.** Contamos con una amplia gama de soluciones expositivas. Góndolas, murales, cabeceras, islas, expositores promocionales...
- **CALIDAD Y SEGURIDAD.** Trabajamos con mobiliario de alta calidad que garantiza una máxima seguridad y una gran robustez de todos los elementos.
- **VERSATILIDAD.** El sistema es compatible con todos los productos y empaquetados de **INDEX®**.
- **OPTIMIZAMOS EL PROCESO DE REPOSICIÓN.** Conocedores de la importancia de facilitar la reposición y mantenimiento del lineal, el mobiliario y los packaging garantizan la máxima ergonomía y practicidad.
- **MÁXIMA VISIBILIDAD DEL PRODUCTO.** Diseñado para mejorar la decisión de compra del cliente final. Dispone de múltiples soluciones visuales de merchandising que complementan y mejoran la implantación.



¿COMO FUNCIONA?

INDEX SPACE STUDIO se trabaja en 6 fáciles pasos:

1. ANÁLISIS

El equipo comercial de **INDEX®** analiza junto al cliente las necesidades (espacio disponible, productos a incorporar, tipo de packaging...).

2. DISEÑO

Con la información obtenida, el equipo especializado en implantaciones optimiza y ordena el surtido.

3. PRESENTACIÓN

La presentación de la implantación propuesta está compuesta por una simulación 3D del lineal y un planograma, donde se refleja la colocación exacta del surtido seleccionado.

4. PREPARACIÓN Y EXPEDICIÓN

Para facilitar el montaje de los expositores, las expediciones de nuevas implantaciones se preparan de forma separada del resto de los pedidos habituales.

5. MONTAJE

El equipo especializado de montadores **INDEX®** se ocupa del montaje inicial íntegramente. Instalación del mobiliario, ubicación del producto e instalación de los elementos de merchandising.

6. MANTENIMIENTO Y SEGUIMIENTO

Aseguramos una revisión regular de cada lineal implantado, proponiendo posibles mejoras, manteniéndolo de forma óptima y actualizada y facilitando el trabajo de los reponedores.

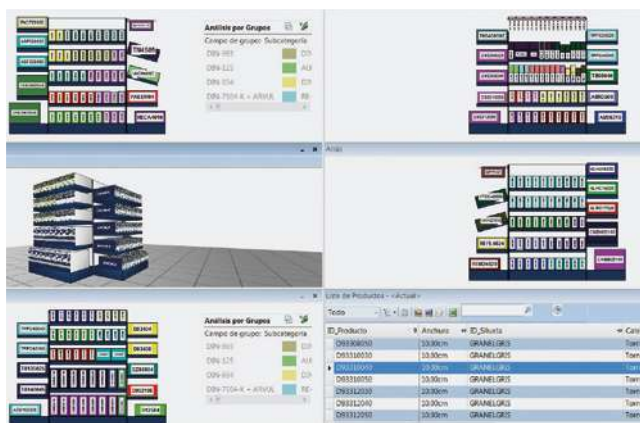



TIPOS DE LINEALES

GÓNDOLA



BALDAS INCLINADAS

Mejora la visualización de todos los productos. Recomendables para formatos de venta en caja ventana y venta INDEXmix.



GAVETAS GRANEL

Disponibles en metal y en plástico reciclado. Ideales para la presentación de productos a granel.



GANCHOS

Disponibles en 30, 40 y 50 cm. Recomendables para la colocación de blísters y productos EASYkits.



BALDAS RECTAS

Indicadas para la presentación de productos pesados como cajas profesionales, botes. Combinadas con separadores es perfecto para productos químicos, siliconas o espumas de poliuretano.

EXPOSITORES PROMOCIONALES Y OTROS



ISLA

Posibles combinaciones.

Medidas por módulo:
100 x 50 x 150 cm (A x F x H)



3 módulos
100 x 150 x 150 cm



4 módulos
100 x 200 x 150 cm



6 módulos
100 x 300 x 150 cm



8 módulos
100 x 400 x 150 cm

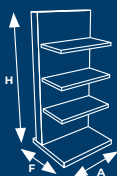

MEDIDAS DISPONIBLES EN STOCK

para expositores góndola/mural, cabeceras e islas:

- A: 100 cm.
- H: 165, 195 y 240 cm.

Otras medidas disponibles **bajo pedido.**

(Plazo de entrega de 4 semanas):

- A: 50, 70, 85 y 130 cm.
- H: 135, 150, 225 y 255 cm.
- F: 50 cm.

TIPOS DE PACKAGING

Conocedores de que cada usuario requiere unas necesidades concretas a nivel de cantidad y embalaje, en INDEX® hemos desarrollado diferentes alternativas para poder satisfacer a cada uno de ellos.

Todos nuestros packaging están fabricados con materiales reciclables y 100% sostenibles y respetuosos con el medioambiente.

Facilitamos la identificación y selección de los productos gracias a la codificación de color en las etiquetas.





CAJA PROFESIONAL

Preparada para los trabajos más exigentes gracias a su cartón reciclado de alta resistencia.



CAJA CON VENTANA

Visual, atractiva. Recomendado para implantar en lineales con autoventa.



BLÍSTER & EASYKITS

La mejor solución para cuando el cliente requiere comprar pocas cantidades.



BOTES DE PLÁSTICO

Son la solución perfecta para los grandes instaladores. Facilitan el manipulado en obra y cuentan con un atractivo diseño.



BOLSAS LIBRE SERVICIO

Listas para colocar en el lineal. Cantidades intermedias entre la caja profesional y el blíster.



GRANEL

Disponible para anclajes, tornillos, abrazaderas y bridas. Una buena solución para implantaciones con espacio de autoventa.



AMPLIAMOS GAMA

FIJACIONES Y ACCESORIOS PARA SISTEMAS DE AISLAMIENTO TÉRMICO (SATE)

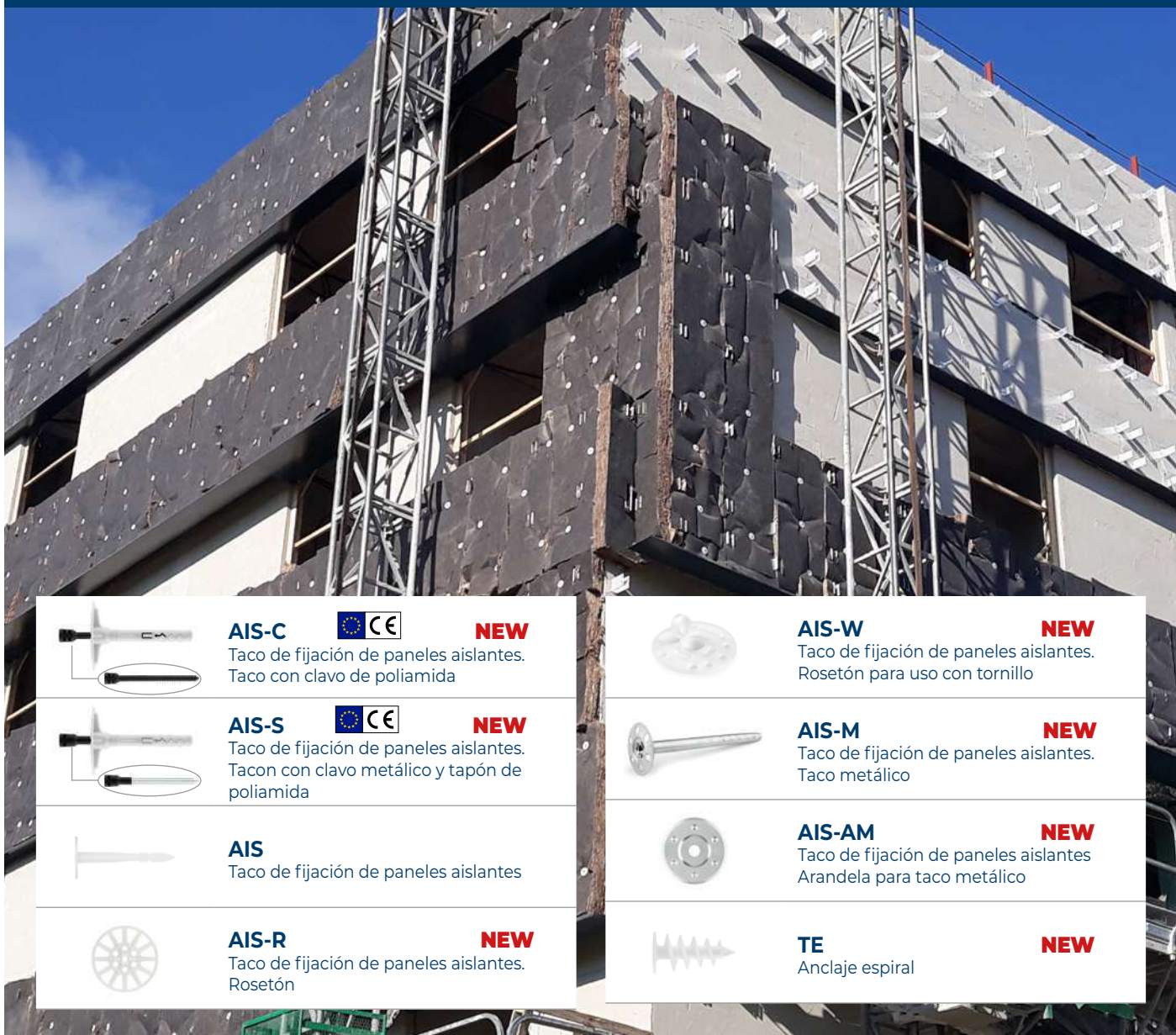

	<p>AIS-C  NEW Taco de fijación de paneles aislantes. Taco con clavo de poliamida</p>		<p>AIS-W NEW Taco de fijación de paneles aislantes. Rosetón para uso con tornillo</p>
	<p>AIS-S  NEW Taco de fijación de paneles aislantes. Tacon con clavo metálico y tapón de poliamida</p>		<p>AIS-M NEW Taco de fijación de paneles aislantes. Taco metálico</p>
	<p>AIS Taco de fijación de paneles aislantes</p>		<p>AIS-AM NEW Taco de fijación de paneles aislantes Arandela para taco metálico</p>
	<p>AIS-R NEW Taco de fijación de paneles aislantes. Rosetón</p>		<p>TE NEW Anclaje espiral</p>

OTRAS NOVEDADES

HE-C4

Anclaje hembra con cono interior para grandes cargas. Con collarín. Inoxidable A4. Homologado ETE Aplicaciones no estructurales



PÁGINA 63

TC-MA

Taco clavable metálico con punta de acero



PÁGINA 66

EQ-8.8

Espárrago con tuerca y arandela para anclaje químico. Cincado 8.8



PÁGINA 79

ACCESORIOS GÁS Y PÓLVORA

Ampliamos la gama de accesorios para fijación directa a pólvora y a gás.



PÁGINA 136

NUEVA GAMA

SISTEMAS DE INSTALACIÓN Y FIJACIONES PARA PANELES FOTOVOLTAICOS

Solución completa para todo tipo de instalaciones fotovoltaicas sobre cubierta



Grapas y galgas para montaje de placas



Perfiles, uniones, guías y empalmes para estructura de apoyo



Conectores + complementos para montaje de estructuras solares



Triángulos para instalación de placas solares



Accesorios regulables para la instalación de placas solares



Accesorios de fijación directa para la instalación de placas solares



Accesorios de estanqueidad para la instalación de placas solares



Kits para instalaciones solares

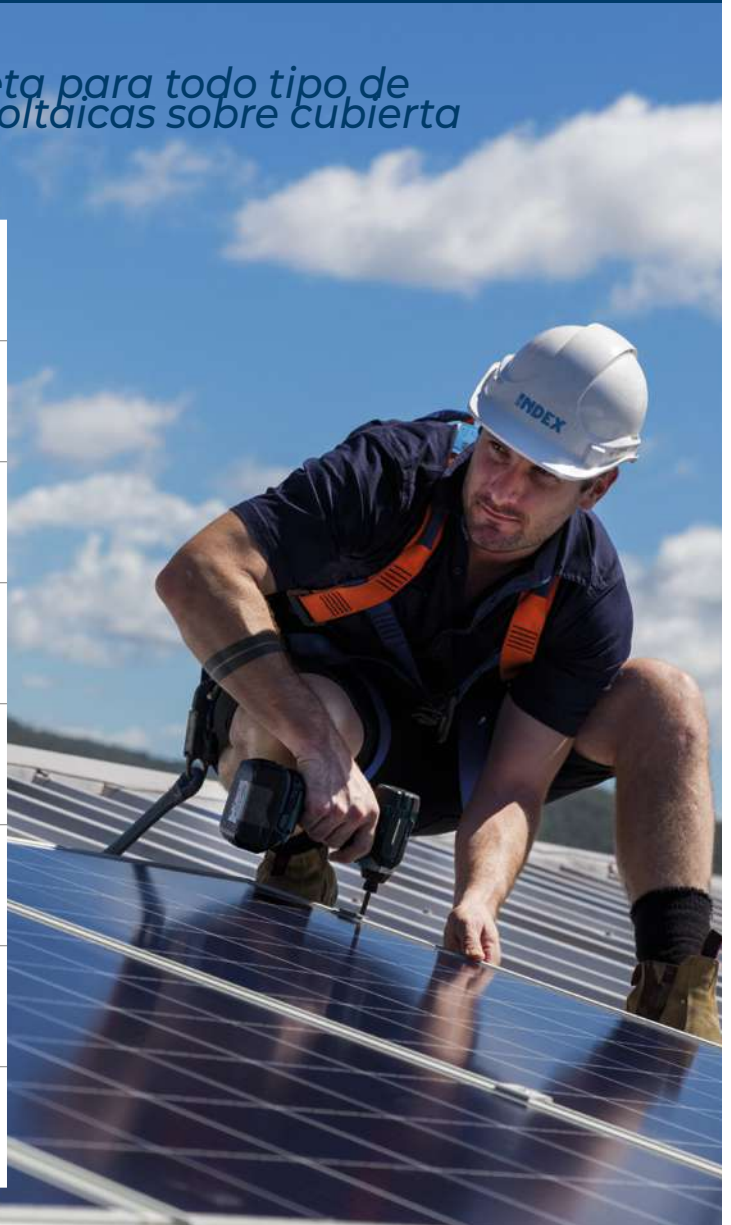

OTRAS NOVEDADES

RS-A2

Tornillo punta broca, cabeza remache y huella PH. Inoxidable A2



PÁGINA 155

SU-AB / SU-CA

Ampliamos la gama de sistemas de fijación rápida en viga con el clip de viga para abrazadera y el clip de viga para cable



PÁGINA 307

RV-ZN 8.8

Varilla roscada. Cincada. Calidad 8.8. 1 metro



PÁGINA 310

AB-ITS / AB-ITD

Abrazaderas inoxidable Indextubeen versión simple y doble



PÁGINA 347

ÍNDICE

















Fijaciones metálicas

NEW





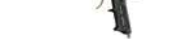













MTP		Opción 1	41				CH-PL		Opción 7	58	
MTP-A4		Opción 1	41				CH-PI		Opción 7	58	
MTP-X		Opción 1	42				CH-INB		Opción 7	59	
MTP-G		Opción 1	42				CH-INN		Opción 7	59	
MTH		Opción 7	43				CH-ES			59	
MTH-A4		Opción 7	44				CH-GA			60	
MTH-A2		Opción 7	45				CH-GE			60	
MTA			46				CH-GF			60	
TWA			47				CH-GF A2			60	
DO-MT			47				CH-AR			61	
THE		Opción 1	49				CH-AF			61	
THA		Opción 1	50				CH-AF A2			61	
THP		Opción 1	50				HE-HO		Opción 7	63	
THT		Opción 1	50				HE-A4		Opción 7	63	
TFE		Opción 1	51				HE-CL		Opción 7	63	
TFN		Opción 1	51				HE-C4			63	
TFS		Opción 1	52				HE-HC			64	
TFM		Opción 1	52				HE-NO			64	
TFF		Opción 1	52				HE-NS			64	
HP			54			NEW	EXP			64	
HP TP			54				EXP-C			64	
HR			54				HC			65	
HE			54				TALA			65	
HE + ARVUL			54				TA-ME			65	
SL-PT		Opción 1	55			NEW	AN-CU			65	
SL-PC		Opción 1	55				TC-MA			66	
CH-TO		Opción 7	57				ZA-CA			66	
CH-A2		Opción 7	57				ZA-TO			66	
CH-8.8		Opción 7	58				ZA-TL			66	
CH-8.8 E			58				ZA-PR			66	
							ZA-ES			67	















ZA-GA	67		MO-V	Opción 7	76		
ZA-GF	67		MO-VS	Opción 7	76		
ZA-AR	67		MO-H	Opción 1	76		
ZA-AF	67		MO-HW	Opción 1	76		
AC-CA	68		MOPURE	Opción 1	77		
AC-CI	68		MOPUR3	Opción 1	77		
AC-TO	68		MOPISTO		78		
AC-ES	68		MOPISSI		78		
AC-GA	68		MOPISPUR6		78		
AC-AR	68		MOPISNEU		78		
HI-CA	69		MOPISP3		78		
HI-CI	69		MOBOMBA		78		
HI-TO	69		MORCANU		78		
HI-GA	69		MORCAPU		78		
HI-AR	69		MORCEPKIT		78		
EPS	70		MO-TN		78		
TRA	70		MO-TM		78		
AVR	70		MO-TR		78		
AVC	70		MO-ES		78		
AN-23	71		CA-QU	Opción 8	79		
AN-51	71		EQ-AC		79		
AN-50 CT	71		EQ-8.8		79		
TC-SO 2	71		EQ-A2		79		
TC-SO 8	71		EQ-A4		79		
AN-TA	71		MS-PR		81		
Fijaciones químicas			MS-TR		81		
MO-PU	Opción 7	75		MS-SF		81	
MO-P+	Opción 7	75		SI-PR		84	
MO-PS+	Opción 7	75		SI-PRS		84	
MO-PSP+	Opción 7	75		SI-UNI		84	

ÍNDICE

SI-UNS 	85	
SE-ACR 	85	
MS-CA	85	
PU-SP	86	
PU-SC	86	
PU-TP	86	
NEW PU-TPR	86	
PU-TC	87	
PU-FP	87	
PU-FC	87	
PU-EP	87	
PU-PI	88	
PU-CA	88	
PU-CL	88	

Fijaciones plásticas

T-NUX A 	91	
T-NUX A A4 	91	
T-NUX E 	91	
T-NUX E A4 	92	
T-NUX T 	92	
T-FUX E 	92	
T-NUX	92	
TC-6A	93	
TC-6E	93	
TC-2A	93	
TC-SP	94	
TC-SP EP	94	
TC-CA	95	

TC-CA EP	95	
TC-A2	94	
TC-CC	94	
TN4S	96	
TN4S EP	96	
TN4S-L	97	
MEDU	98	
TACON	99	
TACOL	99	
TACOL-A	99	
IPA-GR	100	
IPA-GN	100	
IPA-AR	100	
IPA-TO	100	
TA-PL	100	

Fijaciones y accesorios para sistemas de aislamiento térmico (SATE)





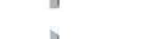

AIS-C 	102	
NEW AIS-S 	102	
AIS	102	
NEW AIS-R	102	
NEW AIS-W	103	
NEW AIS-M	103	
NEW AIS-AM	103	
NEW TE	103	

Fijaciones para materiales huecos















BA-ES	106	
BA-GA	106	

CA-BA	106	
PA-ES	107	
PA-GA	107	
CA-PA	107	
IN-CO	108	
IN-HE	108	
IN-SI	108	
INPIN	109	
INPIS	109	
KITINPIN	109	
ANCLA	110	
TAPLA NY	110	
TAPLA ME	110	
TAPLA ZK	110	

Remaches

RE-NO	112	
RE-IN	113	
RE-CA	113	
RE-BL	113	
RE-NE	114	
RE-FL	114	
TR-AV	115	
TR-CA	115	
TR-CR	115	
RM-MA	116	
RM-PA	116	
RM-EX	116	

Accesorios para cable cadena y cercados

SJ-Z	118	
TS-GA	118	
CM-TENSO	119	
CM-TENSOVE	119	
CM-TT	119	
EV-H	119	
EV-M	120	
GR-Z	120	
GD-Z	121	
CM-BP	122	
CM-BT	122	
CM-TA	122	
CM-TP	122	
CM-UN	122	

Fijaciones y accesorios para placa de yeso

PL-F	CE	124	
PL-EP	CE	124	
PL-RA	CE	125	
PL-TR	CE	125	
PL-CA	CE	125	
CP-PA	CE	126	
CP-GV	CE	126	
CP-AC		126	



ÍNDICE















































CP-MV	126		FP-PI 08	134	
OME 	127		FP-CG12	134	
MAB	127		FP-CGD12	134	
HO-CU 	127		FP-CL12	134	
HO-CR 	127		FP-CLD12	135	
EMP 	128		FP-CT12	135	
CAB 	128		FP-PISCL08	135	
ADU 	128		FP-PISPL08	135	
PCU 	128		FP-PISCL12	135	
SUS 	129		FP-PISCM12	135	
TR-BL	129		FP-PISCT12	135	
TR-13	129		FG-GUN 	136	
TR-15	129		NEW FG-GUNEL 	136	

Fijación directa

FP08GUN 	132		FG-CL	137	
FP12GUN 	132		FG-CLH	137	
FP-IP	132		NEW FG-ARAM	137	
FP-CR	132		NEW FG-ARAM EP	137	
FP-CG 08	133		FG-PLET	137	
FP-CL 08	133		AB-PID	138	
FP-AP 08	133		FG-ABRA	138	
FP-C30	133		FG-BASE	138	
FP-AM 08	133		NEW FG-CAEL	139	
FP-CR 08 M6	134		NEW FG-CLCAR	139	
NEW FP-CR 08 M8	134		FG-IMAN	139	

Tornillos para cubiertas y fachadas

DIN-7504-K	142	
DIN-7504-K A2	142	

DIN-7504-K + ARVUL	143		DIN-7504-P HP Z	153	
DIN-7504-K CP + ARVUL	143		DIN-7504-P HP N	153	
AUTO	144		DIN-7504-P HT	154	
AUTO + ARVUL	144		ABA	154	
ABE BIMETAL	144		ATA	154	
ABE BIMETAL + ARVUL	144		RS	154	
AUTO BIMETAL	145		NEW RS-A2	155	
AUTO BIMETAL + ARVUL	145		BCP Z	155	
DIN-7504-K RE	145		BCP A2	155	
DIN-7504-K RE + ARVUL	146		BCP N	155	
AUE	146		BCP B	155	
AUE + ARVUL	146		BCP CB	155	
PS 3	147		TAEZ	156	
PS 3 + ARVUL	147		TAEN	156	
PS 3 + ARVUL A2	147		DIN-7981 HP Z	156	
PS 5	147		DIN-7981 HP B	157	
PS 5 + ARVUL	147		DIN-7981 HP N	157	
PS 5 + ARVUL A2	147		DIN-7982 HP Z	158	
FIBR	148		CP Z	159	
ARVUL	148		CP A2	159	
ARVUL A2	148		CP B	159	
ATAP	148		CP N	159	
			PVC-10 Z	161	

Tornillos broca, rosca chapa y pvc













DIN-7504-N HP Z	150		PVC-20 B	161	
DIN-7504-N HP A2	151		PVC-20 Z	161	
DIN-7504-N HP N	151		PVC-30	161	
DIN-7504-N HP B	151		PVC-40 B	161	
DIN-7504-N HT	152		PVC-40 Z	162	
DIN-7504-N HC Z	152		PVC-50 B	162	
			PVC-50 Z	162	

ÍNDICE













PVC-70	162	
PVC-70 TP	162	
PVC-90	162	
PVC-VEK	163	
PVC-VEK 13	163	
PVC-VEK 10	163	
PVC-KOM 10	163	

Tornillos para madera

TEX-BP 	166	
TEX-ZP 	167	
TEX-BT 	168	
TEX-ZT 	169	
TEX-A2 	169	
TEC-BT 	171	
TEX-AB	171	
TP-PO B 	174	
TP-PO Z 	176	
TP-TO 	178	
TP-A2 	179	
TR-PO 	179	
DIN-571 	180	
DIN-571 A2 	181	
571 TR 	181	
INV Z 	181	
INV A2 	182	
INV N 	182	
ESTRINV Z	182	
ESTRINV N	182	
TRE-Z	183	
TRE-PV	183	

FS Z	183	
FS 3009	183	
FS 3011	183	
FS 5010	184	
FS 6005	184	
FS 8004	184	
FS 8017	184	
FS 8019	184	
FS 9006	185	
FS 9010	185	
FS 9011	185	
FIMA	185	















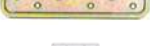





Puntas, alcayatas y hembraillas

AL-RE	188	
AL-PL	188	
AL-RO	189	
AL-RO B	189	
AL-HC	190	
AL-HC B	190	
AL-HA	191	
AL-HA B	191	
HC-RM	192	
HA-RM	192	
PA-CP	193	
PA-CC	193	

PA-CX	194	
GM-Z	194	
CF-B	194	
SV-NB	195	
SV-NM	195	
SV-C	195	
MLTPPOP	196	
MLTBOP	196	
MLTPPOT	197	
MLMULT	197	
MLPLAT	197	

Conectores para madera















SO-UO	200	
SO-UR	200	
SC-EI	200	
SC-ED	200	
SC-LD	201	
SC-GA	201	
SC-RF	201	
SC-RG	201	
SC-AS	201	
SC-CE	201	
SC-OB	202	
NEW SC-OZ	202	
SC-CD Z	202	
SC-CI	202	
SC-EM	202	
SC-ER	203	
SC-GE Z	203	
SC-LC	203	

SC-MX	203	
SC-PD	203	
SC-RE Z	203	
PT-BR	204	
PT-EM	204	
PT-ET	204	
PT-OB	204	
PT-TT	204	
PT-UN	204	
AP-AR	205	
AP-AT	205	
AP-FL	205	
AP-FU Z	205	
AP-PD	205	
AP-PG	206	
AP-PT	206	
AP-UE Z	206	
AP-SB	206	
AP-EN	206	
VM-PF	206	













Tornillería normalizada

DIN-933	208	
DIN-933 A2	210	
DIN-931	211	
DIN-6921	212	
DIN-912	213	
DIN-603/934	214	
DIN-608	215	
DIN-84	215	
DIN-7985	216	

ÍNDICE

DIN-963	217	
DIN-965	217	
DIN-934	218	
DIN-934 A2	218	
DIN-985	219	
DIN-985 A2	219	
DIN-6923	220	
DIN-1587	220	
DIN-125	221	
DIN-125 A2	221	
DIN-9021	222	
DIN-9021 A2	222	
DIN-127	223	
TU-MA	224	
DIN-6798 A	224	

Brocas, puntas y accesorios

B-HDS	226	
PU-PH	226	
PU-TO	226	
PU-OX	227	
PU-PO	227	
PU-CU	227	
BOCA	228	
PU-PM	228	
ATAP	228	
TP-CR B	229	
TP-CR N	229	
TP-TP	229	

Abrazaderas metálicas pesadas











AB-RA	234	
AB-IA	235	
AB-IR	235	
AB-RE	236	
AB-RE V	236	
AB-RE A2	237	
AB-RE A4	237	
AB-RI	238	
AB-RI V	238	
AB-RI A2	239	
AB-RI A4	239	
AB-RI DES	240	
PA-EX	240	
CO-AR	240	
AB-ICP	240	
AB-AIS 13	241	
AB-AIS 19	241	
AB-AIS 30	241	
AB-AIS 40	243	
AB-GA	242	
AB-M8	242	
AB-DE Z	243	
AB-DE G	243	
AB-DP Z	243	
AB-DP G	243	
AB-ZI	244	
AB-ZI A2	244	
AB-SA	245	
AB-GP	245	

Abrazaderas metálicas ligeras





AB-M6	250	
AB-M6 Z	250	
AB-M6 A2	251	
AB-D6	251	
AB-D6 Z	251	
AB-6I	252	
AB-DI	252	
AB-M7 Z	253	
AB-D7 Z	253	
AB-7I Z	254	
AB-7ID Z	254	
AB-PI	255	
AB-PU	255	
AB-IP	256	
AB-SI	256	
AB-TO	256	
AB-SF	257	
AB-SF A2	257	
AB-SF IR	258	
AB-SF IRC	258	
AB-SF IRR	258	
CI-PE	258	
CI-PE A2	258	
CI-PR	259	
AB-CR	259	
NEW AB-ITS	259	
NEW AB-ITD	259	
AB-BU	260	
AB-GM	260	

AB-GS	261	
AB-GD	261	





















Sistemas protección contra incendios

AB-PE	264		
AB-CH	264		 
AB-CI	265		
AN-CU  	265		









Soportes de canalón

TE-MO	268	
TE-GA	268	
TE-GR	268	
TE-PE	268	

Abrazaderas plásticas

BN-N 	271		
BN-B 	272		
TACOBRI N	272		
TACOBRI B	273		
BN-GR	273		
TACOBRI G	273		
BN-DT	273		
BN-ID	274		
BN-PL	274		
BN-BA	274		
BN-VE	274		
BN-MA	275		
BN-AM	275		
BN-AZ	275		
BN-RO	275		
AB-IN	276		
AB-ID	276		

ÍNDICE

AB-GU	277		TU-GU	288	
AB-MUG	277		TU-GRA	289	
AB-PR	278		EG-Z	289	
AB-MS	278		EG-A2	289	
AB-MD	278		PU-Z	289	
AB-TS	279		PG-Z	289	
AB-TD	279		PG-A2	289	
AB-TC	279		SO-TP	290	
FI-CA AB	280		GP-X 21	290	
FI-CA PS	280		GP-X 41	290	
FI-CA PD	280		SP-X	290	
FI-CA CL	280		SP-RX	290	
GR-NY BL	281		SP-UX	291	
GR-NY N	281		PR-X	291	
GR-NY NT	281		RE-SX	291	
Perfilería y Soportación			TG-X	291	
GP-Z	286		TO-GRX	291	
GP-G	286		TU-GX	291	
GP-A2	286		TU-MU	292	
GP-PL	286		TU-RX	292	
GP-PVC	286		TU-RXA	292	
GL-O	287		EG-X	292	
GP-O	287		SC-RX	292	
SP-Z	287		EMP-X	293	
SP-V	287		RT-X	293	
SP-H	288		UN-PX	293	
SP-HX	288		UN-EX	293	
TO-GU	288		UN-TX	293	
TO-GR	288		PG-X	293	
			AB-GX	294	

SO-TP	294
UN-CO	294
SO-PG	294



Sistemas de instalación y fijaciones para paneles fotovoltaicos

NEW KFR-SC	296
NEW PGS-A	296
NEW GM-A	296
NEW GP-XS	296
NEW EMP-XS	296
NEW PSA-A	297
NEW PSA-AV	297
NEW PSA-UN	297
NEW PSE-A	297
NEW PSE-UN	297
NEW KFS-FI	298
NEW KFS-FL	298
NEW TU-RX A2	298
NEW DIN-603 A2	298
NEW DIN-6921 A2	298
NEW DIN-6923 A2	298
NEW DIN-127 A2	299
NEW TPA-R	299
NEW TPA-P	299
NEW TRP-XS	299
NEW NU-XS	299
NEW GS-TC	300
NEW GS-TU	300
NEW STR	300
NEW KFS-MA	300



NEW KFS-AU	300
NEW KFS-RV	301
NEW PMO	301
NEW TAC + ARVUL A2	301
NEW TAC BIMETAL+ ARVUL A2	301
NEW RE-TE	301
NEW ARS-P	302
NEW ARS-S	302
NEW CS-B	302
NEW KC-PSA	302
NEW KC-PSD	302
NEW KC-PSE	303
NEW KC-GPX	303
NEW KC-GPD	303
NEW KT-PSE	303
NEW KT-GPX	303



Sistemas de fijación rápida en viga

SU-MO	306
SU-CL	306
SU-VA	306
SU-CU	307
NEW SU-AB	307
NEW SU-CA	307







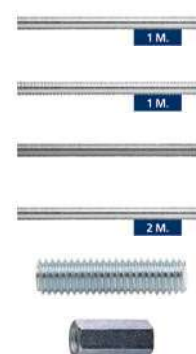









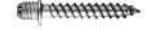



Varilla roscada y accesorios de fijación











RV-ZN	310
NEW RV-ZN 8.8	310
RV-A2	310
RV-2M	311
VR-SE	311
MAHE	311













ÍNDICE

MARE	312	
MARI	312	
MA-MH	312	
AR-FO	312	
GA-FO	313	
GE-SP	313	
AB-TA	313	
AB-TA B	313	
AB-TA A2	314	
AB-TR	314	
AB-PM 7	314	
AB-TG	314	
TM-VR	314	
ES-DR	315	
ES-DA2	315	
AB-FP	316	
AB-FC	316	
PF-A4	316	
PF-ZN	316	

Fijación para sanitarios y climatización



















RA-TRG	318	
RA-TRI	318	
RA-FRE	318	
RA-FIN	318	
RA-RO	319	
RA-FEM	319	
RA-RAY	319	
RA-PES	319	
SA-LN	320	
SA-LH	320	















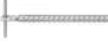

















































SA-IL	320	
SA-WZ	320	
SA-WL	320	
SA-CI	321	
SA-WH	321	
SA-WHM	321	
SA-TE TB	321	
SA-TE AL	321	
CO-SO	322	
CO-KS	322	

Easykits 323



Gama Inox

NEW MTP-A4  Opción 1	330		
MTH-A4  Opción 7	330		
MTH-A2  Opción 7	331		
DO-MT	331		
CH-A2  Opción 7	332		
CH-PI	332		
CH-GF A2	332		
CH-AF A2	333		
HE-A4  Opción 7	333		
NEW HE-C4 	333		
AC-CI	333		



















































HI-CI	334		NEW DIN-127 A2	344	
AVR	334		AB-RE A2	345	
AVC	334		AB-RE A4	345	
EQ-A2	334		AB-RI A2	346	
EQ-A4	335		AB-RI A4	346	
T-NUX A A4 	335		AB-ZI A2	347	
T-NUX E A4 	335		NEW AB-ITS	347	
TC-A2	335		NEW AB-ITD	347	
DIN-7504-K A2	336		AB-M6 A2	347	
ABE BIMETAL	336		AB-SF A2	348	
ABE BIMETAL + ARVUL	336		AB-SF IR	348	
AUTO BIMETAL	337		AB-SF IRC	348	
AUTO BIMETAL + ARVUL	337		AB-SF IRR	348	
PS 3 + ARVUL A2	337		CI-PE A2	348	
PS 5 + ARVUL A2	337		SA-IL	349	
ARVUL A2	338		SA-CI	349	
DIN-7504-N HP A2	338		GP-A2	349	
BCP A2	338		EG-A2	349	
CP A2	338		PG-A2	350	
TEX-A2  	339		RV-A2	350	
TP-A2  	339		MARI	350	
DIN-571 A2 	340		AB-TA A2	350	
INV A2 	340		ES-DA2	351	
DIN-933 A2	341		RE-IN	351	
NEW DIN-6921 A2	342		PF-A4	351	
NEW DIN-603 A2	342				
DIN-934 A2	342				
NEW DIN-6923 A2	343				
DIN-985 A2	343				
DIN-125 A2	343				
DIN-9021 A2	344				

ICONOGRAFÍA











MATERIALES Y RECUBRIMIENTOS DE PRODUCTO

 Inoxidable A2	 Inoxidable A4	 Inoxidable AISI 430	 Bimetal	 Atlantis C4-M
 Atlantis C3-H	 Atlantis C3-M	 Atlantis C3-L	 Atlantis C2-H	 Atlantis C2-M
 Atlantis C2-L	 Bicromatado	 Cincado	 Cincado negro	 Cincado blanco
 Fosfatado	 Galvanizado azul	 Zamak	 Latón	 Cobre
 Pavonado	 Aluminio	 Acero	 Nylon	 PVC
 Plastificado negro	 Plastificado blanco	 Plastificado amarillo	 Polipropileno	

MATERIALES DE USO

 Carpintería aluminio	 Carpintería PVC	 Canalón	 Viga IPN	 Tubo ventilación
 Cartón yeso	 Cable	 Cadena	 Cuerda	 Tubo cromado
 Chapa - perfil pesado	 Ensamblaje Chapa	 Chapa - madera	 Fibro cemento	 Tubo butano
 Madera - metal	 Escayola	 Hormigón armado	 Hormigón fisurado	 Tubo fundición
 Hormigón	 Hormigón hueco	 Ladrillo macizo	 Tubo cobre	 Tubo gas
 Termoarcilla	 Piedra	 Ladrillo de adobe	 Tubo pvc	 Cable
 Madera noble	 Madera pino	 Hormigón celular	 Tubo plástico	 Tubo PPR
 Madera fina	 Panel de madera	 Ladrillo hueco	 Tubo inoxidable	 Tubo acero
 Placa alveolar	 Teja	 Instalación perfiles de aluminio	 Tubo incendios	 Tubo flexible
 SATE alta densidad	 SATE baja densidad	 Cerámico	 Azulejo	 Porcelanato
 Aluminio	 Vidrio			

HUELLAS

















 Hexagonal	 Cuadrada	 PZ-Ranura	 Hexagonal con ranura	 PH
 Hexagonal con arandela estampada	 Allen	 TX	 Ranura	 PZ

CARGAS









 Cargas ligeras	 Cargas medias	 Cargas altas	 Cargas muy altas
---	---	--	--

PROTECCIÓN FRENTE A LA CORROSIÓN

CATEGORÍAS DE CORROSIÓN

CATEGORÍAS DE CORROSIÓN	NIVEL DE CORROSIÓN	AMBIENTES TÍPICOS: EJEMPLOS DE ISO9223		RECUBRIMIENTOS DISPONIBLES INDEX®
		INTERIOR	EXTERIOR	
C1	MUY BAJO	Espacios calefactados con baja humedad relativa y contaminación insignificante, por ejemplo, oficinas, escuelas, museos.	Zona seca o fría, ambiente atmosférico con muy baja contaminación y tiempo de humedad, por ejemplo, ciertos desiertos, ártico central/antártico.	 CINCADO  CINCADO NEGRO  CINCADO BLANCO  FOSFATADO  PLASTIFICADOS
C2	BAJO	Espacios sin calefacción con temperatura variable y humedad relativa. Baja frecuencia de condensación y baja contaminación, por ejemplo, almacenamiento, pabellones deportivos.	Zona templada, ambiente atmosférico con baja contaminación (SO ₂ : <5 g/m ³), por ejemplo, zonas rurales, pequeñas ciudades. Zona seca o fría, ambiente atmosférico con poco tiempo de humedad, por ejemplo desiertos, zonas subárticas.	 ATLANTIS C2-H  ATLANTIS C2-M  ATLANTIS C2-L  BICROMATADO  GALVANIZADO ORGÁNICO AZUL
C3	MEDIO	Espacios con frecuencia moderada de condensación y contaminación moderada por el proceso de producción, por ejemplo, plantas de procesamiento de alimentos, lavanderías, cervecerías, lecherías.	Zona templada, ambiente atmosférico con contaminación media (SO ₂ : 5µ g/m ³ a 30µ g/m ³) o algún efecto de cloruros, por ejemplo, zonas urbanas, zonas costeras con baja deposición de cloruros. Zona tropical y subtropical, atmósfera con baja contaminación.	 ATLANTIS C3-H  ATLANTIS C3-M  ATLANTIS C3-L  INOXIDABLE AISI 430
C4	ALTO	Espacios con alta frecuencia de condensación y alta contaminación por proceso de producción, por ejemplo, plantas de procesamiento industrial.	Zona templada, ambiente atmosférico con alta contaminación (SO ₂ : 30 g/m ³ a 90 g/m ³) o efecto sustancial de cloruros, por ejemplo, zonas urbanas contaminadas, zonas industriales, zonas costeras sin pulverización de agua salada (1-10 km) o, exposición a fuertes efectos de salinidad. Zona subtropical y tropical, atmósfera con contaminación media.	 ATLANTIS C4-M  INOXIDABLE A2 (AISI 304)
C5	MUY ALTO	Espacios con muy alta frecuencia de condensación y/o con alta contaminación por proceso de producción, por ejemplo, minas, cavernas con fines industriales, espacios sin ventilación en zonas subtropicales y tropicales.	Zona templada y subtropical, ambiente atmosférico con contaminación muy alta (SO ₂ : 90 g/m ³ a 250 g/m ³) y/o efecto significativo de cloruros, por ejemplo, zonas industriales, zonas costeras (0-1 km), instalaciones protegidas en la costa.	 INOXIDABLE A4 (AISI 316)

GUÍA RÁPIDA DE SELECCIÓN

		CATEGORÍAS DE CORROSIÓN				
		C1	C2	C3	C4	C5
CONDICIONES MEDIOAMBIENTALES Y/O ATMOSFÉRICAS	 INTERIORES SIN CONDENSACIÓN	✓				
	 INTERIORES CON CONDENSACIÓN TEMPORAL		✓			
	 EXTERIORES EN ZONAS RURALES CON MUY BAJA CONTAMINACIÓN		✓			
	 EXTERIORES CON BAJA CONTAMINACIÓN			✓		
	 EXTERIORES CON CONCENTRACIÓN MODERADA DE CONTAMINACIÓN				✓	
	 ÁREAS COSTERAS					✓
	 EXTERIORES CON FUERTE CONTAMINACIÓN INDUSTRIAL					✓
	 ZONAS CERCANAS A CARRETERAS					✓

* La selección indicada en la tabla es para exposiciones esperadas de 25 años y siempre que cumplan con un mantenimiento adecuado.

* En el caso de instalaciones con productos homologados, el uso en esos ambientes no está cubierto por la Aprobación Técnica Europea (ETA) de anclajes, donde se establece que solo los anclajes de acero inoxidable se pueden instalar en exteriores y garantizando una vida útil del anclaje de 50 años.



FIJACIONES METÁLICAS

Los anclajes macho son una solución profesional y efectiva para la instalación de elementos con garantías de alto rendimiento en hormigón fisurado y no fisurado.

Disponibles en una amplia gama que incluye, entre otros, anclajes con homologación europea ETA 12/0397 para uso en hormigón fisurado y no fisurado, así como homologación sísmica C1&C2 y para resistencia a fuego, y homologación europea ETA 05/0242 para uso en hormigón no fisurado. Aptos para su instalación en aplicaciones interiores como exteriores gracias a las opciones de recubrimientos (ATLANTIS C3-L y cincado) y materiales disponibles (inoxidable A2, inoxidable A4 y acero).



DISEÑO Y GEOMETRÍA



Rebaje del eje como protección de la rosca durante la instalación del anclaje.



Tuerca. La rosca interna permite acoplar el tornillo, facilitando la sujeción y la unión de elementos desmontables. Se suministra premontada.



Arandela. Asegura una óptima presión del elemento a instalar. Se suministra con arandela DIN 125 premontada. Opcionalmente se puede suministrar con arandelas DIN 9021 (serie ancha) o DIN 440 (para madera).



La letra del eje indica la longitud el mismo, permitiendo conocer la longitud del anclaje una vez instalado. Es importante comprobar el espesor a fijar para elegir adecuadamente la longitud del anclaje necesaria.



Marca de profundidad de instalación. La línea pintada en el eje, establece la profundidad recomendada por la homologación para introducir el anclaje en el taladro.



Borde del eje. Permite que el clip se mantenga en su posición durante la instalación.



Clip de expansión y cono. El cono se retrae, expandiendo el clip, ejerciendo presión sobre el material base que, permite la fijación.



Identificación. Modelo y medida del mismo indicado en la clip.

APLICACIONES



- Aplicaciones estructurales
- Vigas y pilares estructurales
- Asientos en estadios
- Estructuras de madera a hormigón
- Barandillas y vallados
- Estanterías y racks
- Vigas y pilares estructurales
- Fijación de elementos no estructurales como carteles, maquinaria, calderas, señales, vallas publicitarias, etc.
- Otras instalaciones

CUALIDADES Y VENTAJAS



MÁXIMA VERSATILIDAD. PROFUNDIDAD DE ANCLAJE VARIABLE.

Permite la instalación hasta dos profundidades de atornillado distintas en M8, M10, M12, M16* y M20*

* En la versión MTH cincado

MÁXIMAS GARANTÍAS. PRODUCTOS HOMOLOGADOS ACORDE A LOS MÁS ALTOS ESTÁNDARES DE CALIDAD.

- Homologación ETA 12/0397 en opción 1 para la instalación en hormigón fisurado y no fisurado (C20/25-C50/60).
- Homologación ETA 05/0242 en opción 7 para la instalación en no fisurado (C20/25-C50/60).
- Homologación sísmica C1&C2.
- Homologado a resistencia a fuego R30-R120 en hormigón.
- Confirmada idoneidad para la instalación de sistemas de rociadores según la norma Vds CEA 4001.



FABRICACIÓN 100% INDEX

Esto nos permite asegurar un riguroso control de los procesos, garantizar la máxima calidad en nuestros productos, brindar el mejor servicio y obtener un coste global competitivo.

GAMA



PRODUCTO	MTP	MTP-A4	MTP-X	MTP-G	MTH	MTH-A4	MTH-A2	MTA
EJE	Z ZINC	A4 INOX	Z ZINC	A4 INOX	Z ZINC	A4 INOX	A2 INOX	Z ZINC
CLIP	A4 INOX	A4 INOX	A4 INOX	A4 INOX	Z ZINC	A4 INOX	A2 INOX	Z ZINC
CE	✓	✓	✓	✓		✓	✓	
CE					✓	✓	✓	
SESMIP	✓		✓					
RESISTENCIA A FUEGO	✓	✓	✓	✓	✓	✓	✓	
RESISTENCIA A LA CORROSIÓN	✓	✓	✓	✓				

EL RECUBRIMIENTO PERFECTO SEGÚN EL NIVEL DE CORROSIÓN



Recubrimiento Atlantis C3-L: válido para condiciones interiores secas (50 años) o en ambientes exteriores tipo C3 según la norma ISO 9223, por un periodo de 25 años.



Recubrimiento Cincado: apto para uso en condiciones interiores secas (categoría C1 según la norma ISO 9223), por un periodo de 50 años.



Material Inoxidable A4: válido para interior y exterior, en zonas costeras o industriales, zonas expuestas a alta contaminación o zonas cercanas a carreteras.



Material Inoxidable A2: válido para espacios interiores con alta frecuencia de condensación o ambientes exteriores que no estén situados próximas a zonas costeras o de elevada contaminación.

Anclaje macho para cargas altas en hormigón fisurado y no fisurado

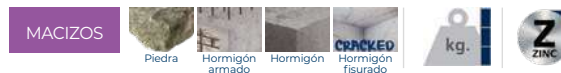

CÓDIGO	HOMOLOGACIÓN SÍSMICA	MEDIDA	€/100	ESPESOR MÁX. A FIJAR	LETRA EJE (LONGITUD)		
•AP08050	-	M8 x 50 Ø8	96,890	2	A	100	800
AP08075	-	M8 x 75 Ø8	102,623	9	C	100	600
AP08095	-	M8 x 95 Ø8	108,223	29	E	100	600
AP08115	-	M8 x 115 Ø8	132,787	49	G	100	400
AP10090	C1	M10 x 90 Ø10	140,317	10	E	100	400
AP10105	C1	M10 x 105 Ø10	166,523	25	F	50	300
AP10115	C1	M10 x 115 Ø10	176,210	35	G	50	200
AP10135	C1	M10 x 135 Ø10	202,507	55	H	50	200
AP10165	C1	M10 x 165 Ø10	243,683	85	K	50	200
AP10185	C1	M10 x 185 Ø10	258,150	105	L	50	150
•AP12080	-	M12 x 80 Ø12	200,713	4	D	50	300
AP12100	C1&C2	M12 x 100 Ø12	220,173	4	E	50	200
AP12110	C1&C2	M12 x 110 Ø12	214,907	14	F	50	200
AP12120	C1&C2	M12 x 120 Ø12	262,467	24	G	50	200
AP12130	C1&C2	M12 x 130 Ø12	271,693	34	H	50	200
AP12150	C1&C2	M12 x 150 Ø12	320,793	54	I	50	100
AP12180	C1&C2	M12 x 180 Ø12	382,660	84	L	50	150
AP12200	C1&C2	M12 x 200 Ø12	447,700	104	M	50	150
AP16145	C1&C2	M16 x 145 Ø16	496,960	28	I	25	100
AP16175	C1&C2	M16 x 175 Ø16	641,757	58	K	25	50
AP16220	C1&C2	M16 x 220 Ø16	753,453	103	O	25	50
AP16250	C1&C2	M16 x 250 Ø16	977,097	133	Q	25	50
AP20170	-	M20 x 170 Ø20	969,703	32	K	20	40
AP20200	-	M20 x 200 Ø20	1.153,063	62	N	20	40
AP24205	-	M24 x 205 Ø24	2.231,480	35	N	10	30
AP24235	-	M24 x 235 Ø24	2.469,347	65	P	10	20

• Medidas sin homologar

MTP

Homologado ETE Opción 1. Eje cincado. Clip Inoxidable A4.



02 Info. Técnica P. 355



INOXIDABLE



CÓDIGO	MEDIDA	€/100	ESPESOR MÁX. A FIJAR	LETRA EJE (LONGITUD)		
APA408075	M8 x 75 Ø8	364,020	9	C	100	600
APA408095	M8 x 95 Ø8	411,667	29	E	100	600
APA408115	M8 x 115 Ø8	539,780	49	G	100	400
APA408135	M8 x 135 Ø8	624,493	69	H	50	300
APA410090	M10 x 90 Ø10	641,667	10	E	100	400
APA410105	M10 x 105 Ø10	686,170	25	F	50	300
APA410115	M10 x 115 Ø10	755,890	35	G	50	300
APA410135	M10 x 135 Ø10	906,770	55	H	50	300
APA410165	M10 x 165 Ø10	1.082,000	85	K	50	100
APA410185	M10 x 185 Ø10	1.157,987	105	L	50	100
APA412110	M12 x 110 Ø12	931,650	14	F	50	200
APA412120	M12 x 120 Ø12	999,500	24	G	50	200
APA412130	M12 x 130 Ø12	1.085,333	34	H	50	200
APA412150	M12 x 150 Ø12	1.268,333	54	I	50	100
APA412180	M12 x 180 Ø12	1.403,000	84	L	50	150
APA412200	M12 x 200 Ø12	1.477,703	104	M	50	100
APA416125	M16 x 125 Ø16	1.918,000	8	G	50	100
APA416145	M16 x 145 Ø16	2.152,667	28	I	25	100
APA416175	M16 x 175 Ø16	2.819,333	58	K	25	50
APA416190	M16 x 190 Ø16	2.919,667	73	L	25	50
APA416220	M16 x 220 Ø16	3.109,720	103	O	20	40
APA420200	M20 x 200 Ø20	4.798,200	62	M	20	40
APA420240	M20 x 240 Ø20	5.507,167	102	P	15	30
APA420285	M20 x 285 Ø20	6.478,589	147	S	10	20

MTP-A4 NEW

Homologado ETE Opción 1. Eje Inoxidable A4. Clip Inoxidable A4.



02 Info. Técnica P. 355



MTP

Anclaje macho para cargas altas en hormigón fisurado y no fisurado

MTP-X

Homologado ETE Opción 1. Eje Cincado. Clip ATLANTIS C3-L.



02 Info Técnica P. 356



MTP-G

Homologado ETE Opción 1. Eje ATLANTIS C3-L. Clip Inoxidable A4.



02 Info Técnica P. 356



CÓDIGO	HOMOLOGACIÓN SÍSMICA	MEDIDA	€/100	Ø BROCA	ESPESOR MÁX. A FIJAR	LETRA EJE (LONGITUD)		
•APX08050	-	M8 x 50 Ø8	82,997	8	2	A	100	800
APX08075	C1	M8 x 75 Ø8	87,883	8	9	C	100	600
APX08080	C1	M8 x 80 Ø8	90,520	8	14	D	100	600
APX08095	C1	M8 x 95 Ø8	95,247	8	29	E	100	600
APX08115	C1	M8 x 115 Ø8	116,897	8	49	G	100	400
APX10090	C1&C2	M10 x 90 Ø10	123,517	10	10	E	100	400
APX10105	C1&C2	M10 x 105 Ø10	139,950	10	25	F	50	300
APX10115	C1&C2	M10 x 115 Ø10	146,830	10	35	G	50	200
APX10135	C1&C2	M10 x 135 Ø10	182,930	10	55	H	50	200
APX10165	C1&C2	M10 x 165 Ø10	213,573	10	85	K	50	200
APX10185	C1&C2	M10 x 185 Ø10	235,843	10	105	L	50	150
•APX12080	-	M12 x 80 Ø12	166,903	12	4	D	50	300
APX12100	C1&C2	M12 x 100 Ø12	184,067	12	4	E	50	200
APX12110	C1&C2	M12 x 110 Ø12	188,223	12	14	F	50	200
APX12120	C1&C2	M12 x 120 Ø12	235,843	12	24	G	50	200
APX12130	C1&C2	M12 x 130 Ø12	246,423	12	34	H	50	200
APX12150	C1&C2	M12 x 150 Ø12	269,103	12	54	I	50	100
APX12180	C1&C2	M12 x 180 Ø12	337,137	12	84	L	50	150
APX12200	C1&C2	M12 x 200 Ø12	393,073	12	104	M	50	150
APX12220	C1&C2	M12 x 220 Ø12	412,727	12	124	O	25	50
APX12255	C1&C2	M12 x 255 Ø12	453,997	12	159	R	25	50
APX16145	C1	M16 x 145 Ø16	477,733	16	28	I	25	100
APX16175	C1	M16 x 175 Ø16	559,370	16	58	K	25	50
APX16220	C1	M16 x 220 Ø16	657,640	16	103	O	25	50
APX16250	C1	M16 x 250 Ø16	846,617	16	133	Q	25	50
APX20170	C1&C2	M20 x 170 Ø20	854,173	20	32	K	20	40
APX20200	C1&C2	M20 x 200 Ø20	975,120	20	62	M	20	40

• Medidas sin homologar

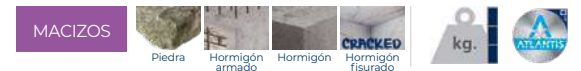

CÓDIGO	MEDIDA	€/100	ESPESOR MÁX. A FIJAR	LETRA EJE (LONGITUD)		
•APG06060	M6 x 60 Ø6	76,007	10	B	200	1.200
•APG06070	M6 x 70 Ø6	78,340	20	C	200	1.200
•APG06100	M6 x 100 Ø6	85,927	50	E	200	800
•APG08050	M8 x 50 Ø8	100,403	2	A	100	800
•APG08060	M8 x 60 Ø8	99,063	12	B	100	800
APG08075	M8 x 75 Ø8	117,997	9	C	100	600
APG08095	M8 x 95 Ø8	127,550	29	E	100	600
APG08115	M8 x 115 Ø8	147,490	49	G	100	400
•APG10070	M10 x 70 Ø10	154,260	5	C	100	400
APG10090	M10 x 90 Ø10	177,707	10	E	100	400
APG10105	M10 x 105 Ø10	192,033	25	F	50	300
APG10115	M10 x 115 Ø10	201,863	35	G	50	200
APG10135	M10 x 135 Ø10	221,990	55	H	50	200
APG10165	M10 x 165 Ø10	272,797	85	K	50	200
APG10185	M10 x 185 Ø10	294,970	105	L	50	150
•APG12080	M12 x 80 Ø12	267,967	4	D	50	300
APG12110	M12 x 110 Ø12	308,553	14	F	50	200
APG12130	M12 x 130 Ø12	365,920	34	H	50	200
APG12150	M12 x 150 Ø12	391,287	54	I	50	100
APG12180	M12 x 180 Ø12	435,873	84	L	50	150
APG12200	M12 x 200 Ø12	425,010	104	M	50	150
APG16125	M16 x 125 Ø16	597,467	8	G	25	100
APG16145	M16 x 145 Ø16	631,877	28	I	25	100
APG16175	M16 x 175 Ø16	694,827	58	K	25	50
APG16220	M16 x 220 Ø16	863,987	103	O	25	50
APG20170	M20 x 170 Ø20	1.074,573	32	K	20	40
APG20200	M20 x 200 Ø20	1.084,887	62	M	20	40

• Medidas sin homologar



Anclaje macho para cargas altas en hormigón no fisurado

MTH

MACIZOS



MTH

Homologado ETE Opción 7. Eje cincado. Clip cincado.



02 Info. Técnica p. 357



CÓDIGO	MEDIDA	€/100	ESPESOR MÁX. A FIJAR	LETRA EJE (LONGITUD)		
AH06060	M6 x 60 Ø6	54,337	2	B	200	1.200
AH06070	M6 x 70 Ø6	56,410	12	C	200	1.200
AH06080	M6 x 80 Ø6	58,470	22	D	200	1.200
AH06090	M6 x 90 Ø6	60,257	32	E	200	1.200
AH06100	M6 x 100 Ø6	62,770	42	E	200	800
AH06110	M6 x 110 Ø6	81,843	52	F	200	800
AH06120	M6 x 120 Ø6	85,923	62	G	100	600
AH06130	M6 x 130 Ø6	99,397	72	H	100	600
AH06140	M6 x 140 Ø6	100,107	82	I	100	400
AH06150	M6 x 150 Ø6	102,717	92	I	100	400
AH06160	M6 x 160 Ø6	110,663	102	J	100	400
AH06170	M6 x 170 Ø6	125,480	112	K	100	400
AH06180	M6 x 180 Ø6	137,860	122	L	100	200
AH08060	M8 x 60 Ø8	67,257	3	B	100	600
AH08075	M8 x 75 Ø8	71,113	5	C	100	600
AH08090	M8 x 90 Ø8	77,090	20	E	100	600
AH08100	M8 x 100 Ø8	82,257	30	E	100	400
AH08115	M8 x 115 Ø8	96,510	45	G	100	400
AH08120	M8 x 120 Ø8	105,617	50	G	100	400
AH08130	M8 x 130 Ø8	111,207	60	H	100	400
AH08155	M8 x 155 Ø8	168,687	85	J	100	200
AH10070	M10 x 70 Ø10	88,063	3	C	100	400
AH10080	M10 x 80 Ø10	100,700	13	D	100	400
AH10090	M10 x 90 Ø10	104,997	10	E	100	400
AH10100	M10 x 100 Ø10	121,067	20	E	100	400
AH10120	M10 x 120 Ø10	127,023	40	G	50	300
AH10140	M10 x 140 Ø10	158,793	60	H	50	200
AH10150	M10 x 150 Ø10	165,193	70	I	50	200
AH10160	M10 x 160 Ø10	188,113	80	J	50	200
AH10170	M10 x 170 Ø10	209,773	90	K	50	200
AH10210	M10 x 210 Ø10	253,780	130	N	50	150
AH10230	M10 x 230 Ø10	269,183	150	P	50	100
AH12090	M12 x 90 Ø12	144,390	13	E	50	200
AH12100	M12 x 100 Ø12	156,067	8	E	50	200
AH12110	M12 x 110 Ø12	161,466	18	F	50	200
AH12120	M12 x 120 Ø12	200,333	28	G	50	200
AH12130	M12 x 130 Ø12	208,863	38	H	50	200
AH12140	M12 x 140 Ø12	209,340	48	H	50	200
AH12160	M12 x 160 Ø12	246,013	68	J	50	100
AH12180	M12 x 180 Ø12	286,063	88	L	50	150
AH12200	M12 x 200 Ø12	334,060	108	M	50	100
AH12220	M12 x 220 Ø12	362,550	128	O	50	100
AH12250	M12 x 250 Ø12	443,203	158	Q	25	50
AH14120	M14 x 120 Ø14	345,747	12	G	25	100
AH14145	M14 x 145 Ø14	405,997	37	I	25	100
AH14170	M14 x 170 Ø14	433,747	62	K	25	100
AH14220	M14 x 220 Ø14	601,427	112	O	25	75
AH14250	M14 x 250 Ø14	671,790	142	Q	25	50
AH16125	M16 x 125 Ø16	354,730	3	G	25	100
AH16145	M16 x 145 Ø16	382,247	23	I	25	100
AH16170	M16 x 170 Ø16	472,703	48	K	25	50
AH16220	M16 x 220 Ø16	563,287	98	O	25	50
AH16250	M16 x 250 Ø16	730,450	128	Q	25	50
AH16280	M16 x 280 Ø16	795,157	158	S	25	50
AH20170	M20 x 170 Ø20	698,093	23	K	20	40
AH20220	M20 x 220 Ø20	869,227	73	O	20	40
AH20270	M20 x 270 Ø20	1.187,933	123	S	20	40

• Medida sin homologar para fuego



Bolsa Autoservicio

CÓDIGO	MEDIDA	€/BOLSA	PCS.	BOLSAS
LSAH06060	M6 x 60 Ø6	15,263	30	6
LSAH08060	M8 x 60 Ø8	12,529	20	6
LSAH08075	M8 x 75 Ø8	11,202	16	6
LSAH08090	M8 x 90 Ø8	10,602	14	6
LSAH10070	M10 x 70 Ø10	9,255	10	5
LSAH10090	M10 x 90 Ø10	8,320	8	6
LSAH10120	M10 x 120 Ø10	8,098	6	6
LSAH12090	M12 x 90 Ø12	9,938	6	5
LSAH12110	M12 x 110 Ø12	10,377	6	5
LSAH16125	M16 x 125 Ø16	7,429	2	6



MTH

Anclaje macho para cargas altas en hormigón no fisurado

MTH-A4

Homologado ETE Opción 7. Eje Inoxidable A4. Clip Inoxidable A4.

INOXIDABLE



02 Info Técnica p. 358



CÓDIGO	MEDIDA	€/100	ESPESOR MÁX. A FIJAR	LETRA EJE (LONGITUD)		
• MIA406045	M6 x 45 Ø6	198,050	1	A	200	1.200
• MIA406060	M6 x 60 Ø6	215,763	2	B	200	1.200
• MIA406080	M6 x 80 Ø6	229,800	22	D	200	1.200
• MIA408050	M8 x 50 Ø8	238,740	4	A	100	800
MIA408075	M8 x 75 Ø8	253,527	5	C	100	600
MIA408090	M8 x 90 Ø8	282,907	20	E	100	600
MIA408115	M8 x 115 Ø8	371,653	45	G	100	400
MIA410070	M10 x 70 Ø10	415,217	3	C	100	400
MIA410090	M10 x 90 Ø10	470,627	10	D	100	400
MIA410120	M10 x 120 Ø10	572,090	40	G	50	300
MIA410150	M10 x 150 Ø10	811,337	70	I	50	200
• MIA412075	M12 x 75 Ø12	620,927	5	C	50	300
MIA412090	M12 x 90 Ø12	625,313	13	D	50	200
MIA412110	M12 x 110 Ø12	684,030	12	F	50	200
MIA412140	M12 x 140 Ø12	820,253	42	I	50	200
• MIA416090	M16 x 90 Ø16	1.483,607	4	D	25	150
MIA416145	M16 x 145 Ø16	1.832,207	23	I	25	100
MIA416170	M16 x 170 Ø16	2.115,780	48	K	25	75
• MIA420120	M20 x 120 Ø20	2.459,464	5	G	20	40
MIA420170	M20 x 170 Ø20	3.361,992	23	K	20	40
MIA420220	M20 x 220 Ø20	4.185,353	73	O	20	40

• Medidas sin homologar
• Medida sin homologar para fuego

Caja con Ventana

CÓDIGO	MEDIDA	€/CAJA	PCS.	CAJAS
VMIA408075	M8 x 75 Ø8	34,754	10	8
VMIA410090	M10 x 90 Ø10	47,562	8	8
VMIA412110	M12 x 110 Ø12	54,416	6	8

Bolsa Autoservicio

CÓDIGO	MEDIDA	€/BOLSA	PCS.	BOLSAS
LSMIA408075	M8 x 75 Ø8	38,350	12	7
LSMIA410090	M10 x 90 Ø10	50,066	8	7
LSMIA412110	M12 x 110 Ø12	54,502	6	5

FICHAS TÉCNICAS DISPONIBLES EN LA WEB

- 1- SELECCIONAR EL PRODUCTO
- 2- IR A DOCUMENTACIÓN TÉCNICA
- 3- SELECCIONAR EL PDF "FICHA TÉCNICA"

The image shows a technical data sheet for the INDEX MTP product. The sheet includes:

- 1. GAMA:** A table listing different models (MTP, MTP-G, MTP-X) with their respective dimensions.
- 2. ACCESORIOS:** A table listing accessories like 'DOMTA' (installation tool) with a description.
- 3. DATOS INSTALACIÓN:** A diagram showing the installation details with dimensions like h_{nom}, h_{ef}, h₁, and h_{min}.
- Material:** Details about the anchor and nut materials, including references to standards like DIN 934 and DIN 934A.
- Características:** A list of product features and applications.
- Referencias:** A table listing technical specifications and standards.



Anclaje macho para cargas altas en hormigón no fisurado

MTH

INOXIDABLE

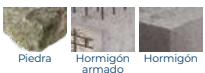

MTH-A2

Homologado ETE Opción 7. Eje Inoxidable A2. Clip Inoxidable A2.



• Medidas sin homologar
• Medida sin homologar para fuego

CÓDIGO	MEDIDA	€/100	ESPOSOR MÁX. A FIJAR	LETRA EJE (LONGITUD)		
•MI06045	M6 x 45 Ø6	161,603	1	A	200	1.200
•MI06060	M6 x 60 Ø6	181,233	2	B	200	1.200
•MI06080	M6 x 80 Ø6	189,553	22	D	200	1.200
•MI06120	M6 x 120 Ø6	226,723	62	G	100	600
•MI06140	M6 x 140 Ø6	286,957	82	I	100	600
•MI06160	M6 x 160 Ø6	321,420	102	J	100	400
•MI06170	M6 x 170 Ø6	360,995	112	K	100	400
•MI06180	M6 x 180 Ø6	391,449	122	L	100	300
•MI08050	M8 x 50 Ø8	195,990	4	A	100	800
MI08075	M8 x 75 Ø8	214,680	5	C	100	600
MI08090	M8 x 90 Ø8	244,303	20	E	100	600
MI08115	M8 x 115 Ø8	316,020	45	G	100	400
MI10070	M10 x 70 Ø10	332,170	3	C	100	400
MI10090	M10 x 90 Ø10	371,820	10	D	100	400
MI10120	M10 x 120 Ø10	435,813	40	G	50	300
MI10150	M10 x 150 Ø10	610,167	70	I	50	200
•MI12075	M12 x 75 Ø12	503,667	5	C	50	300
MI12090	M12 x 90 Ø12	504,820	13	D	50	200
MI12110	M12 x 110 Ø12	546,373	18	F	50	200
MI12140	M12 x 140 Ø12	684,810	48	I	50	200
•MI16090	M16 x 90 Ø16	1.223,710	4	D	25	150
MI16145	M16 x 145 Ø16	1.428,494	23	I	25	100
MI16170	M16 x 170 Ø16	1.566,360	48	K	25	75
•MI20120	M20 x 120 Ø20	1.957,302	5	G	20	40
MI20170	M20 x 170 Ø20	2.432,095	23	K	20	40
MI20220	M20 x 220 Ø20	3.141,695	73	O	20	40



Blíster



Caja con Ventana



Bolsa Autoservicio

CÓDIGO	MEDIDA	€/BOLSA	PCS. BOLSAS
BZMI08075	M8 x 75 Ø8	4,622	2 12
BZMI10090	M10 x 90 Ø10	4,622	2 10

CÓDIGO	MEDIDA	€/CAJA	PCS. CAJAS
VMI08075	M8 x 75 Ø8	31,479	10 8
VMI08090	M8 x 90 Ø8	33,657	10 8
VMI10070	M10 x 70 Ø10	34,779	8 8
VMI10090	M10 x 90 Ø10	38,931	8 8
VMI10120	M10 x 120 Ø10	34,224	6 8
VMI12110	M12 x 110 Ø12	42,459	6 8

CÓDIGO	MEDIDA	€/BOLSA	PCS. BOLSAS
LSMI08075	M8 x 75 Ø8	31,948	12 7
LSMI08090	M8 x 90 Ø8	36,352	12 7
LSMI10070	M10 x 70 Ø10	39,130	10 6
LSMI10090	M10 x 90 Ø10	38,931	8 6
LSMI10120	M10 x 120 Ø10	41,070	8 6
LSMI12110	M12 x 110 Ø12	42,459	6 6

GAMA MTH _NO HAY DOS SIN TRES.

El deseo de responder plenamente a las necesidades de los clientes, nos ha impulsado a mejorar y ampliar nuestra gama de anclajes estructurales homologados MTH.

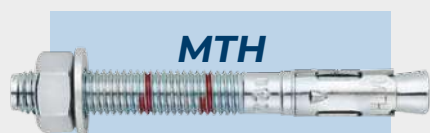

MTH

ZINCADO

PRESTACIONES MEJORADAS
40% MÁS RESISTENTE



MTH-A2

INOXIDABLE A2

NOVEDAD EN EL MERCADO



MTH-A4

INOXIDABLE A4

ALTAS PRESTACIONES

Con el lanzamiento del nuevo anclaje MTH-A2, versión inoxidable con homologación ETA en opción 7, somos pioneros en el mercado en fabricar y distribuir una gama tan extensa de este anclaje. Además, las mejoras aplicadas en el nuevo diseño, ha permitido aumentar las prestaciones de carga en hasta un 40% en las tres versiones (Zincado, inoxidable A2 e inoxidable A4).



MTA

Eje cincado. Clip cincado



02 Info. Técnica p. 259

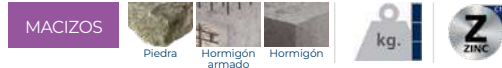

CÓDIGO	MEDIDA	€/100	ESPESOR MÁX. A FIJAR		
AM06045	M6 x 45 Ø6	40,680	1	200	1.200
AM06055	M6 x 55 Ø6	44,157	11	200	1.200
AM06060	M6 x 60 Ø6	43,750	2	200	1.200
AM06065	M6 x 65 Ø6	44,287	7	200	1.200
AM06070	M6 x 70 Ø6	45,427	12	200	1.200
AM06080	M6 x 80 Ø6	47,573	22	200	1.200
AM06085	M6 x 85 Ø6	49,603	27	200	1.200
AM06090	M6 x 90 Ø6	50,180	32	200	1.200
AM06100	M6 x 100 Ø6	52,287	42	200	800
AM06110	M6 x 110 Ø6	57,043	52	200	800
AM06120	M6 x 120 Ø6	60,187	62	100	600
AM06130	M6 x 130 Ø6	60,400	72	100	600
AM06140	M6 x 140 Ø6	75,037	82	100	600
AM06150	M6 x 150 Ø6	85,790	92	100	600
AM06160	M6 x 160 Ø6	91,617	102	100	400
AM06170	M6 x 170 Ø6	115,033	112	100	400
AM06180	M6 x 180 Ø6	121,857	122	100	300
AM08050	M8 x 50 Ø8	51,300	4	100	800
AM08060	M8 x 60 Ø8	52,377	3	100	800
AM08065	M8 x 65 Ø8	55,130	8	100	600
AM08075	M8 x 75 Ø8	56,190	5	100	600
AM08090	M8 x 90 Ø8	61,130	20	100	600
AM08115	M8 x 115 Ø8	74,067	45	100	400
AM08120	M8 x 120 Ø8	75,483	50	100	400
AM08130	M8 x 130 Ø8	86,853	60	100	400
AM08155	M8 x 155 Ø8	150,347	85	100	200
AM10065	M10 x 65 Ø10	79,270	1	100	400
AM10070	M10 x 70 Ø10	74,587	3	100	400
AM10080	M10 x 80 Ø10	79,603	13	100	400
AM10090	M10 x 90 Ø10	83,083	10	100	400
AM10100	M10 x 100 Ø10	91,767	20	100	400
AM10120	M10 x 120 Ø10	99,657	40	50	300
AM10140	M10 x 140 Ø10	113,110	60	50	200
AM10150	M10 x 150 Ø10	127,243	70	50	200
AM10160	M10 x 160 Ø10	158,877	80	50	200
AM10170	M10 x 170 Ø10	166,173	90	50	200
AM10210	M10 x 210 Ø10	230,247	130	50	150
AM10230	M10 x 230 Ø10	260,983	150	50	100
AM12075	M12 x 75 Ø12	113,821	5	50	300
AM12080	M12 x 80 Ø12	118,377	3	50	300
AM12090	M12 x 90 Ø12	122,330	13	50	200
AM12100	M12 x 100 Ø12	126,327	8	50	200
AM12110	M12 x 110 Ø12	127,720	18	50	200
AM12120	M12 x 120 Ø12	152,300	28	50	200
AM12140	M12 x 140 Ø12	170,107	48	50	200
AM12160	M12 x 160 Ø12	194,697	68	50	100
AM12180	M12 x 180 Ø12	226,137	88	50	150
AM12220	M12 x 220 Ø12	296,683	128	50	100
AM12250	M12 x 250 Ø12	367,770	158	25	50
AM14080	M14 x 80 Ø14	222,417	5	50	200
AM14100	M14 x 100 Ø14	255,310	5	50	100
AM14120	M14 x 120 Ø14	286,327	12	25	100
AM14145	M14 x 145 Ø14	348,997	37	25	100
AM14170	M14 x 170 Ø14	379,640	62	25	100
AM14220	M14 x 220 Ø14	506,187	112	25	75
AM14250	M14 x 250 Ø14	555,363	142	25	50
AM16090	M16 x 90 Ø16	271,303	4	25	150
AM16110	M16 x 110 Ø16	274,263	7	25	150
AM16125	M16 x 125 Ø16	280,737	3	25	100
AM16145	M16 x 145 Ø16	301,010	23	25	100
AM16170	M16 x 170 Ø16	376,007	48	25	50
AM16220	M16 x 220 Ø16	456,183	98	25	50
AM16250	M16 x 250 Ø16	608,997	128	25	50
AM16280	M16 x 280 Ø16	662,910	158	25	50



Más gama siguiente página



Anclaje macho para cargas altas

MTA

CÓDIGO	MEDIDA	€/100	ESPESOR MÁX. A FIJAR		
AM20120	M20 x 120 Ø20	462,253	5	20	40
AM20170	M20 x 170 Ø20	554,300	23	20	40
AM20220	M20 x 220 Ø20	704,220	73	20	40
AM20270	M20 x 270 Ø20	943,233	123	20	40
AM24180	M24 x 180 Ø24	1.573,100	10	10	20
AM24260	M24 x 260 Ø24	1.992,453	80	10	20



Blíster

CÓDIGO	MEDIDA	€/BOLSA	PCS.	BOLSAS
BZAM06060	M6 x 60 Ø6	3,427	2	20
BZAM06080	M6 x 80 Ø6	3,427	2	20
BZAM08050	M8 x 50 Ø8	3,427	2	15
BZAM08075	M8 x 75 Ø8	3,427	2	15
BZAM08090	M8 x 90 Ø8	3,427	2	15
BZAM10070	M10 x 70 Ø10	3,427	2	12
BZAM10090	M10 x 90 Ø10	3,427	2	12
BZAM10120	M10 x 120 Ø10	3,427	2	12
BZAM12090	M12 x 90 Ø12	3,427	2	10
BZAM12110	M12 x 110 Ø12	3,427	2	10
BZAM12140	M12 x 140 Ø12	3,427	2	10



Caja con Ventana

CÓDIGO	MEDIDA	€/CAJA	PCS.	CAJAS
VAM06060	M6 x 60 Ø6	9,633	20	8
VAM08075	M8 x 75 Ø8	8,058	12	8
VAM08090	M8 x 90 Ø8	8,566	12	8
VAM10070	M10 x 70 Ø10	5,405	6	8
VAM10090	M10 x 90 Ø10	5,988	6	8
VAM10120	M10 x 120 Ø10	7,118	6	8
VAM12090	M12 x 90 Ø12	8,736	6	8
VAM12110	M12 x 110 Ø12	9,129	6	8

MTA

Eje cincado. Clip cincado



02 Info. Técnica
p. 399



Más gama página anterior

Anclaje macho de suspensión

TWA

MACIZOS



CÓDIGO	MEDIDA	€/100		
TWA06060	6 x 60 Ø6	33,230	100	2.400



Útil de colocación para familia MT

DO-MT

MACIZOS



CÓDIGO	MEDIDA	€/PC		
DOMTA10	M6 - M8 - M10	13,097	5	225
DOMTA20	M12 - M14 - M16 - M20	21,831	5	225



Los anclajes homologados de alto rendimiento de fijación directa en hormigón fisurado y no fisurado son la solución más profesional y efectiva. Su diseño permite una instalación rápida y sencilla garantizando las máximas prestaciones y unos mayores valores de cargas respecto a la versión anterior. El surtido de anclajes TH/TF consta de diferentes modelos de cabezas, aptos para la instalación en elementos estructurales y no estructurales como barandillas, estanterías o elementos que deban desinstalarse o ajustarse.



DISEÑO Y GEOMETRÍA



Rosca doble patentada, diseñada para incrustarse profundamente en el hormigón y garantizar las máximas cargas.



Cabeza THE/TFE: **Arandela estriada estampada en versiones hexagonales**, que asegura un apriete contra el material base, impidiendo que la fijación se afloje.



Cabeza: **Medida estampada en la cabeza** (excepto en Ø5). Permite identificar qué medida se ha instalado.



La **punta templada** garantiza una mayor dureza, durabilidad y facilidad durante la instalación.



Cuerpo de acero al carbono estampado de alta resistencia.

CUALIDADES Y VENTAJAS

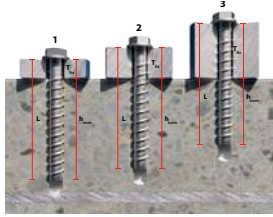

+ VERSATILIDAD

Permite la **instalación con hasta tres profundidades** de atornillado distintas (en versión Ø10).

Adicionalmente **permite desatornillarse** para nivelar o hacer un correcto ajuste del elemento instalado.

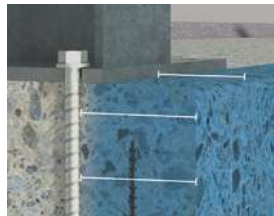

+ PRODUCTIVIDAD

- Genera bajas cargas sobre el hormigón, permitiendo **usar métricas más pequeñas** y, por consiguiente, hacer instalaciones con reducidas distancias entre anclajes y al borde del elemento de hormigón.
- No necesita par de apriete.** Permite asegurarnos de que siempre está perfectamente instalado.
- Instalación EXPRES.** Únicamente requiere un taladro y una máquina de impacto.

MÁXIMAS GARANTÍAS

- Homologado (ETA 20/0046) en opción 1 para la instalación en hormigón fisurado y no fisurado (C20/25-C50/60).
- Homologado (ETA 20/0494) para sistemas redundantes no estructurales en hormigón (C20/25) y losas alveolares (≥ C30/37).
- Homologado a resistencia a fuego R30-R120 en hormigón
- Homologación Sísmica C1&C2.
- Confirmada idoneidad para la instalación de sistemas de rociadores según la norma VdS CEA 4001.

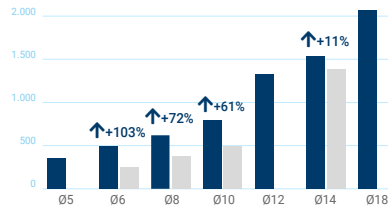

MÁXIMAS PRESTACIONES Y MAYORES VALORES DE CARGAS RESPECTO A LA VERSIÓN ANTERIOR

■ THE (nuevo)
■ THDEX (antiguo)

GAMA



PRODUCTO	THE	THA	THP	THT	TFE	TFN	TFS	TFM	TFF
TIPO DE CABEZA	Hexagonal	Avellanada	Alomada	Truss	Hexagonal	Hexagonal sin arandela	Espárrago	Rosca macho	Rosca hembra
RECUBRIMIENTO	Atlantis	Atlantis	Atlantis	Atlantis	Zinc	Zinc	Zinc	Zinc	Zinc
CE	✓	✓	✓	✓	✓	✓	✓	✓	✓
CE NON STRUCTURAL FIXING	✓	✓	✓	✓	✓	✓	✓	✓	✓
SEISMIC ET & C2	✓	✓	✓	✓	✓	✓	✓	✓	✓
SEISMIC ET	✓	✓	✓	✓	✓	✓	✓	✓	✓
RESISTENCIA A FUEGO	✓	✓	✓	✓	✓	✓	✓	✓	✓
VdS CEA 4001	✓	✓	✓	✓	✓	✓	✓	✓	✓

APLICACIONES



Aplicaciones para versión homologada ETA 20/0046 (instalaciones en hormigón fisurado y no fisurado)

- Aplicaciones estructurales.
- Toldos o señalizaciones provisionales.
- Asientos en estadios.
- Estructuras de madera a hormigón.
- Barandillas y vallados.
- Estanterías y racks.
- Vigas y pilares estructurales.



Aplicaciones para versión homologada ETA 20/0494 (instalaciones no estructurales)

- Fijación de tuberías.
- Conductos de aire acondicionado.
- Bandejas eléctricas o sistemas de cableado.
- Instalaciones en techos de hormigón hueco.
- Instalaciones en techos de losas alveolares.

FABRICACIÓN 100% INDEX

Esto nos permite asegurar un riguroso control de los procesos, garantizar la máxima calidad en nuestros productos, brindar el mejor servicio y obtener un coste global competitivo.



Recubrimiento Atlantis C3-H: válido para condiciones interiores secas (50 años) o en ambientes exteriores tipo C3 según la norma ISO 9223, por un periodo de 25 años.



Recubrimiento Cincado: apto para uso en condiciones interiores secas (categoría C1 según la norma ISO 9223), por un periodo de 50 años.



Anclaje de fijación directa en hormigón

TH/TF

MACIZOS



THE

Homologado ETE Opt.1. Cabeza hexagonal con recubrimiento ATLANTIS C3-H



CÓDIGO	HOMOLOGACIÓN SISMICA	Ø BROCA X LONGITUD	€/100		ESPESOR MÁX. A FIJAR		
THE05040	-	Ø5 x 40	42,653	8	5	100	2.400
THE05050	-	Ø5 x 50	49,470	8	5	100	1.600
THE05060	-	Ø5 x 60	52,833	8	15	100	1.600
THE05080	-	Ø5 x 80	69,300	8	35	50	800
THE05100	-	Ø5 x 100	80,563	8	55	50	800
THE06040	-	Ø6 x 40	54,133	10	5	100	1.600
THE06050	-	Ø6 x 50	58,487	10	15	100	1.200
THE06060	C1	Ø6 x 60	65,127	10	5	100	1.200
THE06070	C1	Ø6 x 70	72,180	10	15	50	600
THE06080	C1	Ø6 x 80	81,160	10	25	50	800
THE06100	C1	Ø6 x 100	102,000	10	45	25	400
THE06120	C1	Ø6 x 120	116,280	10	65	25	400
THE08055	C1 & C2	Ø8 x 55	108,957	13	5	50	600
THE08060	C1 & C2	Ø8 x 60	111,120	13	10	50	600
THE08070	C1 & C2	Ø8 x 70	122,583	13	5	50	200
THE08080	C1 & C2	Ø8 x 80	137,297	13	15	25	400
THE08090	C1 & C2	Ø8 x 90	148,200	13	25	25	400
THE08100	C1 & C2	Ø8 x 100	156,430	13	35	25	400
THE08110	C1 & C2	Ø8 x 110	163,487	13	45	25	400
THE08120	C1 & C2	Ø8 x 120	224,593	13	55	25	400
THE08140	C1 & C2	Ø8 x 140	231,140	13	75	25	300
THE10060	C1 & C2	Ø10 x 60	205,840	15	5	50	200
THE10070	C1 & C2	Ø10 x 70	223,400	15	15	50	200
THE10080	C1 & C2	Ø10 x 80	240,357	15	25	50	300
THE10090	C1 & C2	Ø10 x 90	248,767	15	5	25	300
THE10100	C1 & C2	Ø10 x 100	256,720	15	15	25	300
THE10120	C1 & C2	Ø10 x 120	295,040	15	35	25	200
THE10140	C1 & C2	Ø10 x 140	327,310	15	55	25	100
THE12080	-	Ø12 x 90	310,033	18	15	25	100
THE12090	-	Ø12 x 80	331,240	18	5	25	100
THE12110	C1 & C2	Ø12 x 110	378,433	18	5	25	100
THE12130	C1 & C2	Ø12 x 130	435,133	18	25	25	150
THE12150	C1 & C2	Ø12 x 150	482,057	18	45	25	100
THE14080	-	Ø14 x 80	475,077	21	5	25	150
THE14100	-	Ø14 x 100	564,157	21	25	25	150
THE14120	C1 & C2	Ø14 x 120	657,433	21	5	25	100
THE14130	C1 & C2	Ø14 x 130	745,843	21	15	25	100
THE14140	C1 & C2	Ø14 x 140	803,217	21	25	25	100
THE14160	C1 & C2	Ø14 x 160	873,857	21	45	25	50
THE18100	-	Ø18 x 100	947,020	24	10	20	80
THE18130	-	Ø18 x 130	1.105,277	24	40	20	40
THE18160	C1 & C2	Ø18 x 160	1.288,433	24	20	15	30
THE18180	C1 & C2	Ø18 x 180	1.393,930	24	40	15	30
THE18200	C1 & C2	Ø18 x 200	1.528,777	24	60	10	20

02
P. 360

Info.
Técnica



TH/TF

Anclaje de fijación directa en hormigón

THA

Homologado ETE Opt.1. Cabeza avellanada con recubrimiento ATLANTIS C3-H



CÓDIGO	HOMOLOGACIÓN SISMICA	Ø BROCA X LONGITUD	€/100		ESPESOR MÁX. A FIJAR		
THA05040	-	Ø5 x 40	50,353	25	5	100	2.400
THA05060	-	Ø5 x 60	59,310	25	15	100	1.200
THA05080	-	Ø5 x 80	75,167	25	35	50	800
THA05100	-	Ø5 x 100	84,733	25	55	50	800
THA06045	-	Ø6 x 45	70,240	30	10	100	1.600
THA06050	-	Ø6 x 50	73,240	30	15	100	1.200
THA06060	C1	Ø6 x 60	86,113	30	5	100	1.200
THA06080	C1	Ø6 x 80	103,723	30	25	100	600
THA06120	C1	Ø6 x 120	116,513	30	65	100	400
THA06140	C1	Ø6 x 140	149,373	30	85	100	600
THA08060	C1 & C2	Ø8 x 60	141,860	45	10	50	200
THA08080	C1 & C2	Ø8 x 80	172,387	45	15	25	400
THA08100	C1 & C2	Ø8 x 100	207,333	45	35	25	400
THA08120	C1 & C2	Ø8 x 120	232,670	45	55	25	400
THA10100	C1 & C2	Ø10 x 100	314,080	50	15	25	300
THA10120	C1 & C2	Ø10 x 120	364,597	50	35	25	200

THP

Homologado ETE Opt.1. Cabeza alomada con recubrimiento ATLANTIS C3-H



CÓDIGO	HOMOLOGACIÓN SISMICA	Ø BROCA X LONGITUD	€/100		ESPESOR MÁX. A FIJAR		
THP05040	-	Ø5 x 40	49,610	30	5	100	2.400
THP05060	-	Ø5 x 60	57,073	30	5	100	1.200
THP06040	-	Ø6 x 40	59,650	40	5	100	1.200
THP06050	-	Ø6 x 50	70,340	40	15	100	1.200
THP06060	C1	Ø6 x 60	80,187	40	5	100	1.200
THP06080	C1	Ø6 x 80	99,437	40	25	50	600
THP06100	C1	Ø6 x 100	118,073	40	45	50	200
THP08060	C1 & C2	Ø8 x 60	140,897	45	10	25	400
THP08080	C1 & C2	Ø8 x 80	163,707	45	15	25	300

THT

Homologado ETE Opt.1. Cabeza Truss con recubrimiento ATLANTIS C3-H

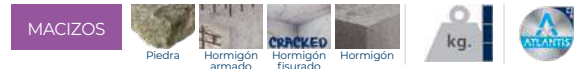

CÓDIGO	HOMOLOGACIÓN SISMICA	Ø BROCA X LONGITUD	€/100		ESPESOR MÁX. A FIJAR		
THT06040	-	Ø6 x 40	77,593	30	5	100	1.600
THT06050	-	Ø6 x 50	92,370	30	15	100	1.200
THT06060	C1	Ø6 x 60	105,303	30	5	100	400



Anclaje de fijación directa en hormigón

TH/TF

MACIZOS



CÓDIGO	HOMOLOGACIÓN SISMICA	Ø BROCA X LONGITUD	€/100	ESPELOR MÁX. A FIJAR	ESPELOR MÁX. A FIJAR	ESPELOR MÁX. A FIJAR	ESPELOR MÁX. A FIJAR
TFE05040	-	Ø5 x 40	36,347	8	5	100	2.400
TFE05050	-	Ø5 x 50	42,157	8	5	100	1.600
TFE05060	-	Ø5 x 60	45,027	8	15	100	1.600
TFE05080	-	Ø5 x 80	59,057	8	35	50	800
TFE05100	-	Ø5 x 100	68,653	8	55	50	800
TFE06040	-	Ø6 x 40	46,130	10	5	100	1.600
TFE06050	-	Ø6 x 50	49,840	10	15	100	1.200
TFE06060	C1	Ø6 x 60	55,500	10	5	100	1.200
TFE06070	C1	Ø6 x 70	61,513	10	15	50	600
TFE06080	C1	Ø6 x 80	69,160	10	25	50	800
TFE06100	C1	Ø6 x 100	86,927	10	45	25	400
TFE06120	C1	Ø6 x 120	99,093	10	65	25	400
TFE08055	C1 & C2	Ø8 x 55	88,820	13	5	50	600
TFE08060	C1 & C2	Ø8 x 60	90,587	13	10	50	600
TFE08070	C1 & C2	Ø8 x 70	99,930	13	5	50	200
TFE08080	C1 & C2	Ø8 x 80	111,917	13	15	25	400
TFE08090	C1 & C2	Ø8 x 90	120,807	13	25	25	400
TFE08100	C1 & C2	Ø8 x 100	127,517	13	35	25	400
TFE08110	C1 & C2	Ø8 x 110	133,263	13	45	25	400
TFE08120	C1 & C2	Ø8 x 120	183,077	13	55	25	400
TFE08140	C1 & C2	Ø8 x 140	188,417	13	75	25	300
TFE10060	C1 & C2	Ø10 x 60	160,163	15	5	50	200
TFE10070	C1 & C2	Ø10 x 70	173,833	15	15	50	200
TFE10080	C1 & C2	Ø10 x 80	187,023	15	25	50	300
TFE10090	C1 & C2	Ø10 x 90	193,573	15	5	25	300
TFE10100	C1 & C2	Ø10 x 100	199,753	15	15	25	300
TFE10120	C1 & C2	Ø10 x 120	229,577	15	35	25	200
TFE10140	C1 & C2	Ø10 x 140	254,683	15	55	25	100
TFE12080	-	Ø12 x 80	229,750	18	5	25	100
TFE12090	-	Ø12 x 90	245,470	18	15	25	100
TFE12110	C1 & C2	Ø12 x 110	280,437	18	5	25	100
TFE12130	C1 & C2	Ø12 x 130	322,457	18	25	25	150
TFE12150	C1 & C2	Ø12 x 150	357,230	18	45	25	100
TFE14080	-	Ø14 x 80	330,057	21	5	25	150
TFE14100	-	Ø14 x 100	391,940	21	25	25	150
TFE14120	C1 & C2	Ø14 x 120	456,740	21	5	25	100
TFE14130	C1 & C2	Ø14 x 130	518,167	21	15	25	100
TFE14140	C1 & C2	Ø14 x 140	558,027	21	25	25	100
TFE14160	-	Ø14 x 160	607,100	21	45	25	50
TFE18100	-	Ø18 x 100	657,930	24	10	20	80
TFE18130	-	Ø18 x 130	767,877	24	40	20	40
TFE18160	C1 & C2	Ø18 x 160	895,123	24	20	15	30
TFE18180	C1 & C2	Ø18 x 180	968,417	24	40	15	30
TFE18200	C1 & C2	Ø18 x 200	1.062,100	24	60	10	20

MACIZOS



CÓDIGO	Ø BROCA X LONGITUD	€/100	ESPELOR MÁX. A FIJAR	ESPELOR MÁX. A FIJAR	ESPELOR MÁX. A FIJAR	ESPELOR MÁX. A FIJAR
TFN14080	Ø14 x 80	475,077	24	5	25	150

TFE

Homologado ETE Opt.1. Cabeza hexagonal con recubrimiento cincado



02 Info. Técnica P. 361



TFN

Homologado ETE Opt.1. Cabeza hexagonal con recubrimiento cincado y sin arandela



02 Info. Técnica P. 362



TH/TF

Anclaje de fijación directa en hormigón

TFS

Homologado ETE Opt.1. Espárrago cincado



02 Info. Técnica p. 362



MACIZOS

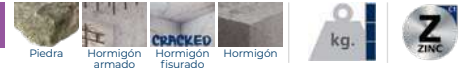

CÓDIGO	HOMOLOGACIÓN SISMICA	Ø BROCA X LONGITUD	€/100		ESPESOR MÁX. A FIJAR		
TFS06100	C1 & C2	Ø6 x 100 (M8)	134,480	5	31	50	800
TFS06120	C1 & C2	Ø6 x 120 (M8)	149,093	5	51	50	600
TFS08110	C1 & C2	Ø8 x 110 (M10)	199,350	7	29	50	400
TFS08130	C1 & C2	Ø8 x 130 (M10)	221,680	7	44	50	400
TFS10120	-	Ø10 x 120 (M12)	290,343	8	26	25	200
TFS10140	-	Ø10 x 140 (M12)	323,650	8	46	25	200

TFM

Homologado ETE Opt.1. Rosca macho métrica cincado



02 Info. Técnica p. 362



MACIZOS

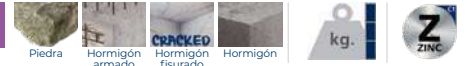

CÓDIGO	Ø BROCA X LONGITUD	€/100			
TFM06035	Ø6 x 35 (M8)	97,850	13	100	400
TFM06055	Ø6 x 55 (M10)	114,923	13	100	600

TFF

Homologado ETE Opt.1. Rosca hembra métrica cincada



02 Info. Técnica p. 362



MACIZOS

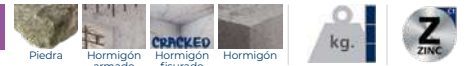

CÓDIGO	Ø BROCA X LONGITUD	€/100			
TFF06035	Ø6 x 35 (M8-M10)	118,647	13	50	200
TFF06055	Ø6 x 55 (M8-M10)	128,103	13	50	200



INDEXcal V4

SOFTWARE DE CÁLCULO DE ANCLAJES

El programa de cálculo de anclajes INDEXcal es la herramienta adecuada para que los diseñadores de soluciones estructurales cumplan con los requisitos del Eurocódigo 2, parte 4. Comprueba de forma rápida y detallada todos los anclajes de nuestro catálogo en base a parámetros de entrada del usuario, indicando su adecuación o no a las mismas.

Prestaciones:

- Válido para hormigón fisurado y no fisurado de distintas resistencias.
 - Cálculo para condiciones de fuego y/o sísmico.
- Indica la razón de rechazo de aquellos anclajes que no cumplan los requisitos estructurales.
- Personalización de placas de anclajes, incluyendo rectangulares, circulares, hexagonales, octogonales e irregulares.
 - Permite incluir en el diseño perfiles normalizados o personalizados.
 - Opción filtrado anclajes.
- Multilingüe: disponible en castellano, inglés, francés, alemán y holandés.
- Acceso directo a fichas técnicas y homologaciones desde el propio software.
 - Informe completo en pdf, personalizable.
 - Actualizable on-line.
 - Interface usuario 3D.
- Disponible para un uso gratuito, pudiéndose descargar en la página web.
- Permite incluir cálculo con varias hipótesis de cargas de forma simultánea.

CALIDAD CERTIFICADA

Nuestra obsesión por la perfección lleva a ampliar continuamente nuestras certificaciones y homologaciones de laboratorios independientes y de los principales organismos oficiales que garantizan la máxima calidad tanto en productos como en sistemas de gestión.



Conformidad Europea



Evaluación Técnica Europea



Homologación Sísmica



Underwriters Laboratories



ICC-ES®



Resistencia al fuego



Emissiones VOC reducidas



Leadership in Energy and Environmental Design



Homologación FM



HO

Tornillo para hormigón

HP

Cabeza plana, Tx, bicromatado y cincado



Info Técnica
P. 363

MACIZOS



		MEDIDA	€/100		Ø BROCA		
HPZ75072	HP75072	7,5 x 72 Ø6	39,117	TX30	6	100	1.200
HPZ75092	HP75092	7,5 x 92 Ø6	48,183	TX30	6	100	1.200
HPZ75112	HP75112	7,5 x 112 Ø6	61,787	TX30	6	100	800
HPZ75132	HP75132	7,5 x 132 Ø6	70,847	TX30	6	100	600
HPZ75152	HP75152	7,5 x 152 Ø6	90,553	TX30	6	100	600
HPZ75182	HP75182	7,5 x 182 Ø6	127,222	TX30	6	100	300
HPZ75212	-	7,5 x 212 Ø6	186,839	TX30	6	100	300



Bolsa Autoservicio

CÓDIGO	MEDIDA	€/BOLSA	PCS.	BOLSAS
LSHP75072	7,5 x 72 Ø6	6,211	14	7
LSHP75092	7,5 x 92 Ø6	7,274	14	7
LSHP75112	7,5 x 112 Ø6	7,671	12	7
LSHP75132	7,5 x 132 Ø6	8,797	12	7

HP TP

Tapón para tornillo HP



MACIZOS



CÓDIGO	MEDIDA	€/100			
TPBLANC		5,424	TX30	2.000	24.000
TPMARRO		5,424	TX30	2.000	24.000

HR

Cabeza cilíndrica, Tx



Info Técnica
P. 363

MACIZOS



CÓDIGO	MEDIDA	€/100		Ø BROCA		
HR75072	7,5 x 72 Ø6	42,060	TX25	6	100	1.200
HR75092	7,5 x 92 Ø6	49,870	TX25	6	100	1.200
HR75112	7,5 x 112 Ø6	65,523	TX25	6	100	800
HR75132	7,5 x 132 Ø6	76,863	TX25	6	100	600

HE

Tornillo con cabeza hexagonal



MACIZOS



CÓDIGO	MEDIDA	€/100	Ø BROCA	LLAVE DE INSTALACIÓN		
HE65032	6,5 x 32 Ø5	17,330	5	8+ ranura	1.000	3.000
HE65045	6,5 x 45 Ø5	21,297	5	8+ ranura	500	2.000
HE65057	6,5 x 57 Ø5	27,467	5	8+ ranura	500	2.000
HE65070	6,5 x 70 Ø5	35,090	5	8+ ranura	500	1.500
HE65080	6,5 x 80 Ø5	41,807	5	8+ ranura	250	1.000
HE65100	6,5 x 100 Ø5	51,103	5	8+ ranura	250	750
HE65125	6,5 x 125 Ø5	66,350	5	8+ ranura	250	1.000

HE + ARVUL

Tornillo montado con arandela vulcanizada de acero-EPDM



MACIZOS



CÓDIGO	MEDIDA	€/100	Ø BROCA	LLAVE DE INSTALACIÓN		
HE1665032	6,5 x 32 P16 Ø5	27,143	5	8+ ranura	1.000	2.000
HE1665045	6,5 x 45 P16 Ø5	31,960	5	8+ ranura	500	1.500
HE1665057	6,5 x 57 P16 Ø5	38,987	5	8+ ranura	500	1.500
HE1665070	6,5 x 70 P16 Ø5	44,127	5	8+ ranura	500	1.000
HE1665080	6,5 x 80 P16 Ø5	53,097	5	8+ ranura	250	750
HE1665100	6,5 x 100 P16 Ø5	62,133	5	8+ ranura	250	750
HE1665125	6,5 x 125 P16 Ø5	78,843	5	8+ ranura	250	500



Anclaje de seguridad para grandes cargas en hormigón

SL



CÓDIGO	MEDIDA	€/100	ESPESOR MÁX. A FIJAR		
SLPT10070	M6 x 70 Ø10	303,770	10	50	600
SLPT10080	M6 x 80 Ø10	318,743	20	50	600
SLPT10100	M6 x 100 Ø10	355,743	40	50	300
SLPT10110	M6 x 110 Ø10	377,733	50	25	150
SLPT12080	M8 x 80 Ø12	366,243	5	50	300
SLPT12090	M8 x 90 Ø12	385,510	15	50	200
SLPT12100	M8 x 100 Ø12	401,760	25	50	200
SLPT12120	M8 x 120 Ø12	438,617	45	25	200
SLPT16100	M10 x 100 Ø16	626,413	15	25	150
SLPT16120	M10 x 120 Ø16	707,677	35	25	100
SLPT16140	M10 x 140 Ø16	799,143	55	20	60
SLPT16160	M10 x 160 Ø16	889,260	75	20	60
SLPT18110	M12 x 110 Ø18	872,110	10	20	80
SLPT18120	M12 x 120 Ø18	927,083	20	20	80
SLPT18140	M12 x 140 Ø18	1.023,513	40	20	80
SLPT18150	M12 x 150 Ø18	1.082,330	50	20	80
SLPT18170	M12 x 170 Ø18	1.215,927	70	15	45
SLPT18200	M12 x 200 Ø18	1.359,760	100	15	30
SLPT24140	M16 x 140 Ø24	1.571,677	20	10	40
SLPT24170	M16 x 170 Ø24	1.848,060	50	10	30
SLPT24200	M16 x 200 Ø24	2.132,370	80	10	20
SLPT24220	M16 x 220 Ø24	2.316,453	100	10	20
SLPT28170	M20 x 170 Ø28	2.444,117	20	10	20
SLPT28200	M20 x 200 Ø28	2.829,887	50	10	20
SLPT28240	M20 x 240 Ø28	3.373,160	90	5	10

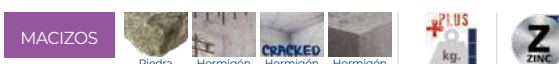

CÓDIGO	MEDIDA	€/100	ESPESOR MÁX. A FIJAR		
SLPC10070	M6 x 70 Ø10	429,573	10	50	600
SLPC10080	M6 x 80 Ø10	452,870	20	50	600
SLPC10100	M6 x 100 Ø10	494,997	40	50	300
SLPC12100	M8 x 100 Ø12	588,647	25	50	200
SLPC16100	M10 x 100 Ø16	850,020	15	25	150
SLPC16120	M10 x 120 Ø16	922,983	35	25	100
SLPC18120	M12 x 120 Ø18	1.143,490	20	20	80

SL-PT

Homologado ETE Opt.1. Cabeza hexagonal



02 Info. Técnica p. 364



SL-PC

Homologado ETE Opt.1. Cabeza avellanada



02 Info. Técnica p. 364



Los anclajes de camisa CH son una solución ideal para la instalación de elementos estructurales en hormigón no fisurado como pasamanos, líneas de cables, mobiliario urbano o estanterías metálicas.

La geometría del anclaje garantiza una gran capacidad de carga, un alto grado de seguridad y una sencilla instalación. Al apretar el anclaje, el cono se introduce en la camisa de expansión (sin girarse gracias a los antiguos), expandiéndola contra el material a fijar. El surtido de anclajes CH consta de diferentes modelos de cabezas en función del uso que se requiera.



DISEÑO Y GEOMETRÍA



- 1. Cono con aletas antigiro** permite que el anclaje no gire, asegurando la expansión de la camisa y facilitando su instalación.
- 2. Apertura de la camisa.** Optimiza la inserción del cono y facilita su expansión.
- 3. Información práctica** para la instalación (diámetro y longitud) estampada en la camisa.
- 4. Diseño de la camisa** para asegurar una expansión más eficiente.
- 5. Marca de profundidad** requerida para asegurar un correcto rendimiento.
- 6. Goma azul** con aletas antigiro que facilitan la instalación.
- 7. Arandela** que aumenta la superficie de fijación.

CUALIDADES Y VENTAJAS



GARANTÍA ANTIGIRO. FACILITA LA INSTALACIÓN.

El anclaje consta de varios elementos antigiro (cono, camisa y goma) que permiten que el anclaje no gire cuando se comienza a instalar, facilitando la instalación y garantizando una óptima expansión y rendimiento.



MÁXIMAS GARANTÍAS. HOMOLOGADO ACORDE A LOS MÁX ALTOS ESTÁNDARES DE CALIDAD.

Homologado (ETA 18/0018) para usos no estructurales en hormigón.



VERSATILIDAD. MÚLTIPLES USOS.

Indicado para la instalación de cargas estáticas o cuasi-estáticas en hormigón no fisurado y hormigón armado. Permite el desmontaje del anclaje, desatornillando el tornillo o elemento roscado.

APLICACIONES



- Fijaciones estructurales en hormigón no fisurado.
- Fijación de señales, estanterías, paneles, pórticos, barandillas, toldos, postes de vallas.
- Mobiliario urbano, asientos de cines, teatros o estadios.
- Bandejas de cables
- Puertas
- Fachadas
- Fijaciones temporales

FABRICACIÓN 100% INDEX

Esto nos permite asegurar un riguroso control de los procesos, garantizar la máxima calidad en nuestros productos, brindar el mejor servicio y obtener un coste global competitivo.

GAMA



PRODUCTO	CH-TO	CH-A2	CH-8.8	CH-8.8 E	CH-PL	CH-PI	CH-ES	CH-INB	CH-INN
CABEZA DEL TORNILLO	Tornillo hexagonal 6.8	Tornillo hexagonal inoxidable A2	Tornillo hexagonal 8.8	Tornillo especial para espesores reducidos	Cabeza plana	Cabeza plana inoxidable A2	Espárrago	Cabeza inviolable	Cabeza inviolable lacada en negro
RECUBRIMIENTO/MATERIAL DEL TORNILLO	ZINC	A2 INOX	ZINC	ZINC	ZINC	A2 INOX	ZINC	ZINC	BLACK



PRODUCTO	CH-GA	CH-GE	CH-GF	CH-GF A2	CH-AR	CH-AF	CH-AF A2
CABEZA DEL TORNILLO	Gancho	Gancho espiral	Gancho forjado	Gancho forjado inoxidable A2	Argolla	Argolla forjada	Argolla forjada inoxidable A2
RECUBRIMIENTO/MATERIAL DEL TORNILLO	ZINC	ZINC	ZINC	A2 INOX	ZINC	ZINC	A2 INOX



EL RECUBRIMIENTO PERFECTO SEGÚN EL NIVEL DE CORROSIÓN



Recubrimiento Cincado: apto para uso en condiciones interiores secas (categoría C1 según la norma ISO 923), por un periodo de 50 años.



Recubrimiento Cincado negro: apto para uso en condiciones interiores secas (categoría C1 según la norma ISO 923), por un periodo de 50 años.



Material Inoxidable A2: válido para espacios interiores con alta frecuencia de condensación o ambientes exteriores que no estén situados próximas a zonas costeras o de elevada contaminación.



Anclaje antigiro para cargas medias

CH

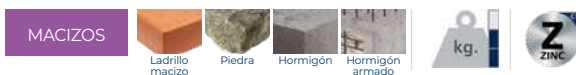

CÓDIGO	MEDIDA	€/100		
ACHT08C	M6 x 45 Ø8	34,563	200	1.200
ACHT08L	M6 x 60 Ø8	40,043	200	800
•ACHT09C	M6 x 45 Ø9	41,093	200	800
•ACHT09L	M6 x 60 Ø9	46,513	200	800
ACHT10C	M8 x 60 Ø10	55,157	100	600
ACHT10L	M8 x 80 Ø10	64,660	100	400
•ACHT11C	M8 x 60 Ø11	65,393	100	400
•ACHT11L	M8 x 80 Ø11	78,757	100	400
ACHT12C	M10 x 70 Ø12	89,910	100	200
ACHT12L	M10 x 100 Ø12	111,107	50	200
•ACHT14C	M10 x 70 Ø14	113,303	100	200
•ACHT14L	M10 x 100 Ø14	137,727	50	200
ACHT16C	M12 x 80 Ø16	174,327	50	200
ACHT16L	M12 x 110 Ø16	211,517	50	100
ACHT20C	M16 x 110 Ø20	381,160	25	50
•ACHT25C	M20 x 130 Ø25	1.088,713	15	45

• Medidas sin homologar

CH-TO

Tornillo hexagonal 6.8. Homologado ETE Opt.7



02 Info. Técnica P. 365



Blíster



Caja con Ventana



Bolsa Autoservicio

CÓDIGO	MEDIDA	€/BOLSA	PCS. BOLSAS
BZACHT08C	M6 x 45 Ø8	3,427	2 15
BZACHT08L	M6 x 60 Ø8	3,427	2 15
BZACHT10C	M8 x 60 Ø10	3,427	2 15
BZACHT10L	M8 x 80 Ø10	3,427	2 15
BZACHT12C	M10 x 70 Ø12	3,427	2 10
BZACHT12L	M10 x 100 Ø12	3,427	2 10

CÓDIGO	MEDIDA	€/CAJA	PCS. CAJAS
VACHT08C	M6 x 45 Ø8	6,312	15 8
VACHT08L	M6 x 60 Ø8	7,107	15 8
VACHT10C	M8 x 60 Ø10	6,686	10 8
VACHT10L	M8 x 80 Ø10	7,837	10 8
VACHT12C	M10 x 70 Ø12	8,446	8 8
VACHT12L	M10 x 100 Ø12	8,030	6 8
VACHT16C	M12 x 80 Ø16	8,122	4 8

CÓDIGO	MEDIDA	€/BOLSA	PCS. BOLSAS
LSACHT08C	M6 x 45 Ø8	9,912	24 6
LSACHT08L	M6 x 60 Ø8	7,806	16 6
LSACHT10C	M8 x 60 Ø10	5,826	8 6
LSACHT10L	M8 x 80 Ø10	6,409	8 6
LSACHT12C	M10 x 70 Ø12	8,446	8 6
LSACHT12L	M10 x 100 Ø12	9,808	8 6
LSACHT16C	M12 x 80 Ø16	8,164	4 5

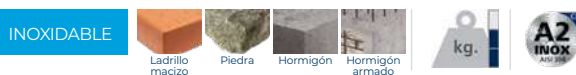

CÓDIGO	MEDIDA	€/100		
ACHTA208C	M6 x 45 Ø8	108,713	100	1.200
ACHTA208L	M6 x 60 Ø8	122,817	100	600
•ACHTA209C	M6 x 45 Ø9	123,027	100	1.200
•ACHTA209L	M6 x 60 Ø9	142,097	100	600
ACHTA210C	M8 x 60 Ø10	176,140	100	600
ACHTA210L	M8 x 80 Ø10	202,623	100	400
•ACHTA211C	M8 x 60 Ø11	211,907	100	400
•ACHTA211L	M8 x 80 Ø11	249,623	100	400
ACHTA212C	M10 x 70 Ø12	297,137	100	200
ACHTA212L	M10 x 100 Ø12	363,387	50	200
•ACHTA214C	M10 x 70 Ø14	395,263	100	300
•ACHTA214L	M10 x 100 Ø14	440,873	50	200
ACHTA216C	M12 x 80 Ø16	585,907	50	100
ACHTA216L	M12 x 110 Ø16	741,410	50	100
ACHTA220C	M16 x 110 Ø20	1.522,157	25	75

• Medidas sin homologar

CH-A2

Inoxidable A2. Homologado ETE Opt.7



02 Info. Técnica P. 365



Blíster



Caja con Ventana



Bolsa Autoservicio

CÓDIGO	MEDIDA	€/BOLSA	PCS. BOLSAS
BZACHTA208C	M6 x 45 Ø8	4,622	2 15
BZACHTA208L	M6 x 60 Ø8	4,622	2 15
BZACHTA210C	M8 x 60 Ø10	4,622	2 15
BZACHTA210L	M8 x 80 Ø10	4,622	2 15

CÓDIGO	MEDIDA	€/CAJA	PCS. CAJAS
VACHTA208C	M6 x 45 Ø8	13,641	10 8
VACHTA208L	M6 x 60 Ø8	15,859	10 8
VACHTA210C	M8 x 60 Ø10	14,204	6 8
VACHTA210L	M8 x 80 Ø10	16,912	6 8
VACHTA212C	M10 x 70 Ø12	15,938	4 8
VACHTA212L	M10 x 100 Ø12	19,673	4 8

CÓDIGO	MEDIDA	€/BOLSA	PCS. BOLSAS
LSACHTA208C	M6 x 45 Ø8	14,734	12 6
LSACHTA208L	M6 x 60 Ø8	17,128	12 6
LSACHTA210C	M8 x 60 Ø10	17,044	8 6
LSACHTA210L	M8 x 80 Ø10	20,293	8 6
LSACHTA212C	M10 x 70 Ø12	21,519	6 6
LSACHTA212L	M10 x 100 Ø12	19,673	4 5

CH

Anclaje antigiro para cargas medias

CH-8.8

Tornillo hexagonal 8.8. Homologado ETE Opt.7



02 Info. Técnica P. 365



MACIZOS

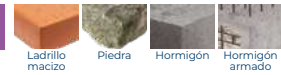

CÓDIGO	MEDIDA	€/100		
ACHT8808C	M6 x 45 Ø8	40,967	200	1.200
ACHT8808L	M6 x 60 Ø8	47,040	200	800
ACHT8810C	M8 x 60 Ø10	64,623	100	600
ACHT8810L	M8 x 80 Ø10	78,567	100	400
ACHT8812C	M10 x 70 Ø12	105,343	100	200
ACHT8812L	M10 x 100 Ø12	130,180	50	200
ACHT8816C	M12 x 80 Ø16	198,933	50	200
ACHT8816L	M12 x 110 Ø16	241,377	50	100
ACHT8820C	M16 x 110 Ø20	427,180	25	50

CH-8.8 E

Tornillo hexagonal 8.8 para espesores reducidos



02 Info. Técnica P. 366

MACIZOS

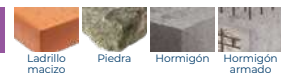

CÓDIGO	MEDIDA	€/100		
ACHT8808E	M6 x 40 Ø8	45,853	200	1.200
ACHT8810E	M8 x 40 Ø10	78,297	100	600



Especialmente indicado para la fijación sobre espesores reducidos de hormigón.

CH-PL

Cabeza plana. Homologado ETE Opt.7



02 Info. Técnica P. 366



MACIZOS

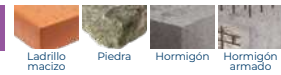

CÓDIGO	MEDIDA	€/100			
ACHTPL08C	M6 x 45 Ø8	61,547	4	100	1.600
ACHTPL08L	M6 x 60 Ø8	90,263	4	100	1.200
ACHTPL10C	M8 x 60 Ø10	101,143	5	100	400
ACHTPL10L	M8 x 80 Ø10	136,347	5	100	400
ACHTPL12C	M10 x 70 Ø12	179,083	6	50	400
ACHTPL12L	M10 x 100 Ø12	307,047	6	50	300

CH-PI

Cabeza plana inoxidable A2. Homologado ETE Opción 7



02 Info. Técnica P. 366



INOXIDABLE

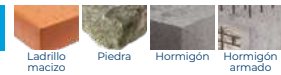

CÓDIGO	MEDIDA	€/100			
ACHTPI08C	M6 x 45 Ø8	116,590	4	100	1.200
ACHTPI08L	M6 x 60 Ø8	149,287	4	100	1.200
ACHTPI10C	M8 x 60 Ø10	219,947	5	100	600
ACHTPI10L	M8 x 80 Ø10	260,373	5	100	400
ACHTPI12C	M10 x 70 Ø12	347,790	6	50	300
ACHTPI12L	M10 x 100 Ø12	410,607	6	50	300



Anclaje antigiro para cargas medias

CH

MACIZOS



CÓDIGO	MEDIDA	€/100			
ACHINB08C	M6 x 45 Ø8	59,180	TX40	100	1.200
ACHINB08L	M6 x 60 Ø8	67,830	TX40	100	800
ACHINB10C	M8 x 60 Ø10	83,930	TX40	100	600
ACHINB10L	M8 x 80 Ø10	98,997	TX40	100	400



Blíster

CÓDIGO	MEDIDA	€/BOLSA	PCS.	BOLSAS
BZACHINB08C	M6 x 45 Ø8	3,427	2	15
BZACHINB10C	M8 x 60 Ø10	3,427	2	15

GRATIS - 1 punta TX40 (Cod. PUTO40) en cada caja

Disponible estrella por separado en la página 226

CH-INB

Cabeza inviolable cincada.
Homologado ETE Opt.7



02 Info. Técnica
P. 366



CH-INN

Cabeza inviolable cincada negra.
Homologado ETE Opt.7



02 Info. Técnica
P. 366



MACIZOS



CÓDIGO	MEDIDA	€/100		
ACHE08C	M6 x 45 Ø8	64,050	200	1.200
ACHE09C	M6 x 45 Ø9	66,297	200	800
ACHE10C	M8 x 60 Ø10	94,743	100	600
ACHE10L	M8 x 80 Ø10	110,320	100	400
ACHE11C	M8 x 60 Ø11	104,477	100	600
ACHE11L	M8 x 80 Ø11	115,460	100	400
ACHE12C	M10 x 70 Ø12	134,247	100	200
ACHE12L	M10 x 100 Ø12	175,700	50	200
ACHE14C	M10 x 70 Ø14	147,640	100	200
ACHE14L	M10 x 100 Ø14	198,263	50	200

CH-ES

Espárrago



02 Info. Técnica
P. 366

CH

Anclaje antigiro para cargas medias

CH-GA

Gancho



02 Info Técnica P. 366

MACIZOS

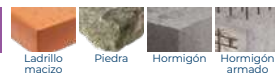

CÓDIGO	MEDIDA	€/100	APERTURA GANCHO		
ACHG08C	M6 x 45 Ø8	58,633	10	100	600
ACHG09C	M6 x 45 Ø9	61,373	10	100	600
ACHG10C	M8 x 60 Ø10	97,503	13	100	400
ACHG11C	M8 x 60 Ø11	107,373	13	100	400
ACHG12C	M10 x 70 Ø12	157,763	14	50	200
ACHG14C	M10 x 70 Ø14	180,777	14	50	200
ACHG16C	M12 x 80 Ø16	286,473	22	25	100

Blíster

CÓDIGO	MEDIDA	€/BOLSA	PCS. BOLSA	
BZACHG08C	M6 x 45 Ø8	3,427	2 15	
BZACHG10C	M8 x 60 Ø10	3,427	2 15	
BZACHG12C	M10 x 70 Ø12	3,427	2 10	

Caja con Ventana

CÓDIGO	MEDIDA	€/CAJA	PCS. CAJAS
VACHG08C	M6 x 45 Ø8	6,702	10 8
VACHG10C	M8 x 60 Ø10	6,802	6 8

Bolsa Autoservicio

CÓDIGO	MEDIDA	€/BOLSA	PCS. BOLSA
LSACHG08C	M6 x 45 Ø8	7,856	12 6
LSACHG10C	M8 x 60 Ø10	6,802	6 6

CH-GE

Gancho espiral



02 Info Técnica P. 371

MACIZOS

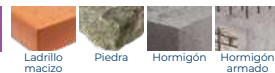

CÓDIGO	MEDIDA	€/100		
ACHGE10	M8 x 115 Ø10	227,267	25	150
ACHGE12	M10 x 135 Ø12	267,400	15	90

CH-GE

GANCHO EN ESPIRAL PARA SUJECIÓN DE REDES, MALLAS Y CABLES

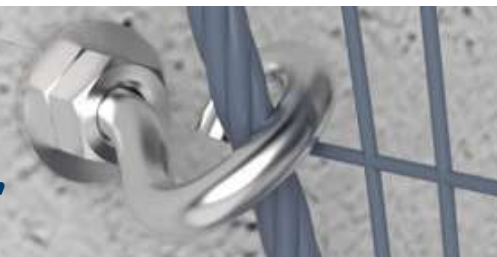

CH-GF

Gancho forjado



02 Info Técnica P. 367

MACIZOS

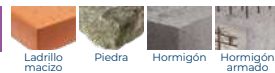

CÓDIGO	MEDIDA	€/100	APERTURA GANCHO		
ACHGF008C	M6 x 45 Ø8	112,580	10	100	600
ACHGF010C	M8 x 60 Ø10	153,290	11	100	400
ACHGF012C	M10 x 70 Ø12	246,220	14	50	200

CH-GF A2

Gancho forjado. Inoxidable A2



02 Info Técnica P. 371

INOXIDABLE

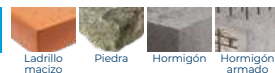

CÓDIGO	MEDIDA	€/100	APERTURA GANCHO		
ACHGA208C	M6 x 45 Ø8	414,233	10	100	600
ACHGA210C	M8 x 60 Ø10	615,310	11	100	400
ACHGA212C	M10 x 70 Ø12	857,143	14	50	200

Anclaje antigiro para cargas medias

MACIZOS



CÓDIGO	MEDIDA	€/100	Ø OJO		
ACHA08C	M6 x 45 Ø8	58,633	10	100	600
ACHA09C	M6 x 45 Ø9	61,373	10	100	600
ACHA10C	M8 x 60 Ø10	97,503	13	100	400
ACHA11C	M8 x 60 Ø11	107,373	13	100	200
ACHA12C	M10 x 70 Ø12	157,763	14	50	200
ACHA14C	M10 x 70 Ø14	180,777	14	50	200
ACHA16C	M12 x 80 Ø16	286,473	22	25	100

CH-AR

Argolla



02 Info. Técnica P. 367



Blíster



Caja con Ventana



Bolsa Autoservicio

CÓDIGO	MEDIDA	€/BOLSA	PCS. BOLSAS
BZACHA08C	M6 x 45 Ø8	3,427	2 15
BZACHA10C	M8 x 60 Ø10	3,427	2 15
BZACHA12C	M10 x 70 Ø12	3,427	2 10

CÓDIGO	MEDIDA	€/CAJA	PCS. CAJAS
VACHA08C	M6 x 45 Ø8	6,825	10 8
VACHA10C	M8 x 60 Ø10	6,802	6 8

CÓDIGO	MEDIDA	€/BOLSA	PCS. BOLSAS
LSACHA08C	M6 x 45 Ø8	9,303	14 6
LSACHA10C	M8 x 60 Ø10	6,802	6 6

MACIZOS



CÓDIGO	MEDIDA	€/100	Ø OJO		
ACHAFO08C	M6 x 45 Ø8	106,513	10	100	600
ACHAFO10C	M8 x 60 Ø10	139,127	12	100	400
ACHAFO12C	M10 x 70 Ø12	213,553	14	50	200

CH-AF

Argolla forjada



02 Info. Técnica P. 367

INOXIDABLE



CÓDIGO	MEDIDA	€/100	Ø OJO		
ACHAA208C	M6 x 45 Ø8	454,853	10	100	600
ACHAA210C	M8 x 60 Ø10	725,567	11	100	400
ACHAA212C	M10 x 70 Ø12	986,037	14	50	200

CH-AF A2

Argolla forjada. Inoxidable A2



02 Info. Técnica P. 367

Disponibles ganchos, argollas y gancho espiral por separado en la página 312



HE

Los anclajes de expansión por deformación con rosca hembra están indicados para la instalación de tuberías, bandejas porta cables, conductos de ventilación o sistemas rociadores contraincendios. Disponen de homologación europea ETE para aplicaciones estructurales en hormigón no fisurado (según DEE 332023) y para fijación de sistemas redundantes no estructurales en hormigón fisurado incluyendo condiciones de exposición a fuego (según DEE 330747). Disponibles con recubrimiento ATLANTIS C3-L, inoxidable A4 y cincado, permitiendo su instalación en aplicaciones interiores como exteriores.



DISEÑO Y GEOMETRÍA



Rosca interior. El anclaje tiene una primera parte con rosca hembra, donde se instala el perno métrico y/o la varilla roscada (no suministrada con el producto). Su rosca interna métrica permite la aplicación en múltiples instalaciones, garantizando una máxima versatilidad.

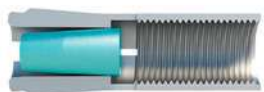

Cono interior. En la parte inferior dispone de un cono interior que durante la instalación produce una expansión de las aletas de la camisa.



Aletas. La expansión del cono interior produce una expansión de las aletas, generando un rozamiento contra las paredes del material base, que permite la fijación.



Protección. El plástico ubicado en el interior del anclaje, evita que el cono se caiga durante la instalación o transporte de la caja.



Versión con collarín HE-CL. La versión con collarín previene que el anclaje se introduzca en exceso en el agujero del material base durante la instalación en caso de haber realizado un agujero más profundo del requerido en la documentación.



Identificación. La medida del anclaje está troquelada en el cuerpo del anclaje para facilitar su identificación y así saber en todo momento el diámetro de broca necesario, así como el útil de expansión a utilizar.



Versión corta, HE-HC. La versión HE-HC permite la instalación en zonas donde se presuma una alta densidad de armaduras de refuerzo; por ejemplo, en la parte inferior de forjados. Dada su escasa longitud (25 mm) no es previsible que incida en la armadura.

APLICACIONES



Anclaje para fijación de sistemas estructurales y no estructurales

- Instalaciones de techos suspendidos
- Sistemas de rociadores contraincendios
- Sistemas de suspensión para tuberías
- Bajantes con varillas
- Sistemas de ventilación y/o conductos de aire
- Bandejas portacables
- Fijación de sistemas estructurales en hormigón no fisurado con cargas estáticas o cuasi-estáticas
- Fijación de sistemas no estructurales redundantes en hormigón fisurado o aplicaciones puntuales en hormigón no fisurado.

FABRICACIÓN 100% INDEX

Esto nos permite asegurar un riguroso control de los procesos, garantizar la máxima calidad en nuestros productos, brindar el mejor servicio y obtener un coste global competitivo.

CUALIDADES Y VENTAJAS

ANCLAJE DESMONTABLE Y REUTILIZABLE.

Los tornillos o varillas utilizados pueden ser desmontados, dejando la superficie diáfana (queda la camisa y el cono en el interior del taladro). El anclaje instalado se puede utilizar para una nueva fijación.

MÁXIMAS GARANTÍAS. PRODUCTOS HOMOLOGADOS ACORDE A LOS MÁS ALTOS ESTÁNDARES DE CALIDAD.

- Homologado (ETA 14/0135) para sistemas no estructurales redundantes en hormigón fisurado y no fisurado (C12/15 a C50/60), incluyendo condiciones de exposición a fuego.
- Homologado (ETA 14/0068) para aplicaciones estructurales en hormigón no fisurado (C20/25-C50/60).
- Homologado FM para instalación de sistemas de rociadores contraincendios.
- Confirmada idoneidad para la instalación de sistemas de rociadores según la norma VdS CEA 4001.



FÁCIL INSTALACIÓN.

Gracias al útil EXP con protector de goma, permite una expansión del anclaje controlada, segura y ergonómica.

¿Cómo saber si el anclaje está correctamente instalado?

Una vez introducida la camisa, golpear con el expansionador hasta que el borde superior de la camisa se quede marcada con unas muescas.

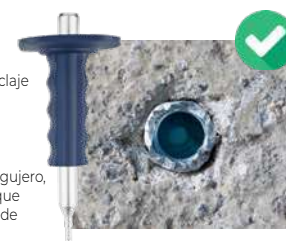

GAMA



PRODUCTO	HE-HO	HE-A4	HE-CL	HE-C4	HE-HC	HE-NO	HE-NS
RECUBRIMIENTO/MATERIAL	ZINC	A4 INOX	ZINC	A4 INOX	ZINC	ZINC	ATLANTIS
CE NON STRUCTURAL FIXING	✓	✓	✓	✓	✓		
CE UNCRACKED CONCRETE	✓		✓				
FM APPROVED	✓	✓	✓	✓	✓		
EXPANSION TOOL	✓	✓	✓	✓	✓		

EL RECUBRIMIENTO PERFECTO SEGÚN EL NIVEL DE CORROSIÓN

Recubrimiento Atlantis C3-L: válido para condiciones interiores secas (50 años) o en ambientes exteriores tipo C3 según la norma ISO 9223, por un periodo de 25 años.

Recubrimiento Cincado: apto para uso en condiciones interiores secas (categoría C1 según la norma ISO 9223), por un periodo de 50 años.

Material Inoxidable A4: válido para interior y exterior, en zonas costeras o industriales, zonas expuestas a alta contaminación o zonas cercanas a carreteras.

Anclaje hembra con cono interior para grandes cargas

MACIZOS



CÓDIGO	MEDIDA	€/100	LONGITUD		
HEHOM06	M6 x 25 Ø8	20,387	25	100	3.200
HEHOM08	M8 x 30 Ø10	26,417	30	100	1.600
HEHOM10	M10 x 40 Ø12	44,183	40	50	800
HEHOM12	M12 x 50 Ø15	81,223	50	50	400
HEHOM16	M16 x 65 Ø20	208,487	65	25	200
HEHOM20	M20 x 80 Ø25	417,756	80	25	100
HEHOM12D	M12 x 50 Ø16	94,803	50	50	400



* Para asegurar equipos de corte por diamante



HE-HO

Cincado. Homologado ETE Opt.7 y para aplicaciones no estructurales



02 Info. Técnica P. 368

INOXIDABLE



CÓDIGO	MEDIDA	€/100	LONGITUD		
HEA4M06	M6 x 25 Ø8	110,967	25	100	4.000
HEA4M08	M8 x 30 Ø10	158,223	30	100	2.200
HEA4M10	M10 x 40 Ø12	237,783	40	50	1.000
HEA4M12	M12 x 50 Ø15	473,433	50	50	600
HEA4M16	M16 x 65 Ø20	1.057,930	65	25	250
HEA4M20	M20 x 80 Ø25	1.932,287	80	25	100

02 Info. Técnica P. 368



HE-A4

Inoxidable A4. Homologado ETE Aplicaciones no estructurales



MACIZOS



CÓDIGO	MEDIDA	€/100	LONGITUD		
HECLOM06	M6 x 25 Ø8	24,113	25	100	3.200
HECLOM08	M8 x 30 Ø10	33,280	30	100	1.600
HECLOM10	M10 x 40 Ø12	52,030	40	50	800
HECLOM12	M12 x 50 Ø15	94,430	50	50	400
HECLOM16	M16 x 65 Ø20	265,429	65	25	200
HECLOM12D	M12 x 50 Ø16	110,103	50	50	400



* Para asegurar equipos de corte por diamante



HE-CL

Con collarín. Cincado. Homologado ETE Opt.7 y para aplicaciones no estructurales



02 Info. Técnica P. 368

INOXIDABLE



CÓDIGO	MEDIDA	€/100	LONGITUD		
HEC4M06	M6 x 25 Ø8	152,948	25	100	3.200
HEC4M08	M8 x 30 Ø10	218,993	30	100	1.600
HEC4M10	M10 x 40 Ø12	338,341	40	50	800
HEC4M12	M12 x 50 Ø15	608,319	50	50	400

02 Info. Técnica P. 368



HE-C4 **NEW**

Con collarín. Inoxidable A4. Homologado ETE Aplicaciones no estructurales



HE

Anclaje hembra con cono interior para grandes cargas

HE-HC

Versión corta. Cincado. Homologado ETE Aplicaciones no estructurales



HE-NO

Cincado



HE-NS

ATLANTIS C3-L



EXP

Expansionador manual para anclajes hembra (excepto HE-HC)



NEW EXP-C

Expansionador manual para anclajes hembra HE-HC



MACIZOS



CÓDIGO	MEDIDA	€/100	LONGITUD		
HEHCM08	M8 x 25	30,947	25	100	1.600
HEHCM10	M10 x 25	50,402	25	50	800
HEHCM12	M12 x 25	92,660	25	50	800

MACIZOS



CÓDIGO	MEDIDA	€/100	LONGITUD		
HENOM06	M6 x 25 Ø8	14,640	25	100	4.000
HENOM08	M8 x 30 Ø10	20,217	30	100	2.200
HENOM10	M10 x 40 Ø12	33,810	40	50	1.000
HENOM12	M12 x 50 Ø15	62,147	50	50	600
HENOM16	M16 x 65 Ø20	156,610	65	25	250
HENOM20	M20 x 80 Ø25	307,353	80	25	100



Blíster



Caja con Ventana



Bolsa Autoservicio

CÓDIGO	MEDIDA	€/BOLSA	PCS. BOLSAS	CÓDIGO	MEDIDA	€/CAJA	PCS. CAJAS	CÓDIGO	MEDIDA	€/BOLSA	PCS. BOLSAS
BZHENOM06	M6 x 25 Ø8	3,427	4 20	VHENOM06	M6 x 25 Ø8	3,398	15 8	LSHENOM06	M6 x 25 Ø8	5,639	30 7
BZHENOM08	M8 x 30 Ø10	3,427	4 20	VHENOM08	M8 x 30 Ø10	4,148	15 8	LSHENOM08	M8 x 30 Ø10	7,463	30 7
BZHENOM10	M10 x 40 Ø12	3,427	2 15					LSHENOM10	M10 x 40 Ø12	7,169	16 7

MACIZOS

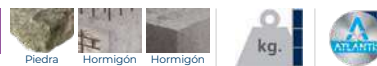

CÓDIGO	MEDIDA	€/100	LONGITUD		
HENSM08	M8 x 30 Ø10	32,512	30	100	1.600
HENSM10	M10 x 40 Ø12	52,624	40	50	1.000
HENSM12	M12 x 50 Ø15	96,741	50	50	600
HENSM16	M16 x 65 Ø20	243,782	65	25	250

MACIZOS



CÓDIGO	MEDIDA	VÁLIDO PARA	€/100		
EXHBM06	M6	M6 x 25 Ø8	1.325,042	1	10
EXHBM08	M8	M8 x 30 Ø10	1.325,042	1	10
EXHBM10	M10	M10 x 40 Ø12	1.325,042	1	10
EXHBM12	M12	M12 x 50 Ø15	1.325,042	1	10
EXHBM16	M16	M16 x 65 Ø20	1.514,337	1	10
*EXHBM20	M20	M20 x 80 Ø25	1.577,434	1	10

*Medidas sin mango

MACIZOS



CÓDIGO	MEDIDA	€/100		
EXHBM08C	M8 (HE-HC)	1.325,042	1	10
EXHBM10C	M10 (HE-HC)	1.325,042	1	10
EXHBM12C	M12 (HE-HC)	1.325,042	1	10



Anclaje para losa alveolar. Homologado ETE

HC

HUECOS



CÓDIGO	MEDIDA	€/100	Ø BROCA		
HCM06	M6	93,273	10	100	600
HCM08	M8	112,563	12	50	600
HCM10	M10	160,123	16	25	300



Anclaje para losa alveolar



02 Info. Técnica
P. 368



Taco de latón para fijaciones ligeras en materiales macizos

TALA

MACIZOS



CÓDIGO	MEDIDA	€/100		
TALA532	W5/32 x 16 Ø5	11,680	300	9.600
TALAM04	M4 x 16 Ø5	11,680	300	9.600
TALAM05	M5 x 18 Ø6	19,060	200	6.400
TALAM06	M6 x 23 Ø8	26,283	200	4.800
TALAM08	M8 x 28 Ø10	47,187	100	2.400
TALAM10	M10 x 33 Ø12	73,710	150	1.800
TALAM12	M12 x 38 Ø15	158,607	150	900



02 Info. Técnica
P. 369



Blíster



Caja con Ventana



Bolsa Autoservicio

CÓDIGO	MEDIDA	€/BOLSA	PCS. BOLSAS	CÓDIGO	MEDIDA	€/CAJA	PCS. CAJAS	CÓDIGO	MEDIDA	€/BOLSA	PCS. BOLSAS
BZTALAM06	M6 x 23 Ø8	3,427	4 20	VTALAM06	M6 x 23 Ø8	8,285	25 8	LSTALAM06	M6 x 23 Ø8	14,910	50 8
BZTALAM08	M8 x 28 Ø10	3,427	4 20	VTALAM08	M8 x 28 Ø10	8,797	15 8	LSTALAM08	M8 x 28 Ø10	15,841	30 7
BZTALAM10	M10 x 33 Ø12	3,427	2 15	VTALAM10	M10 x 33 Ø12	13,864	15 8	LSTALAM10	M10 x 33 Ø12	20,791	25 5

Taco de expansión metálico

TA-ME

MACIZOS



CÓDIGO	MEDIDA	€/100	UD. MIN. VENTA		
TAME05030	M5 x 30 Ø5	13,907	200	100	4.500
TAME06032	M6 x 32 Ø6	15,607	200	100	2.400
TAME08038	M8 x 38 Ø8	25,880	200	100	1.200
TAME08060	M8 x 60 Ø8	35,810	100	50	600
TAME10060	M10 x 60 Ø10	41,653	50	50	600



02 Info. Técnica
P. 369



Blíster

CÓDIGO	MEDIDA	€/BOLSA	PCS. BOLSAS	BOLSAS
BZTAME06032	M6 x 32 Ø6	3,427	4	20
BZTAME08038	M8 x 38 Ø8	3,427	4	20
BZTAME08060	M8 x 60 Ø8	3,427	4	20
BZTAME10060	M10 x 60 Ø10	3,427	4	20

Anclaje metálico tipo cuña. Homologado ETE

AN-CU

MACIZOS



CÓDIGO	MEDIDA	€/100	Ø BROCA		
ANCU06040	6 x 40 Ø6	28,713	6	100	1.200
ANCU06070	6 x 70 Ø6	45,007	6	100	1.200



02 Info. Técnica
P. 369



TC-MA

Taco clavable metálico con punta de acero



METAL

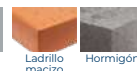

CÓDIGO	MEDIDA	€/100		
TCMA05022	5 x 22 Ø5	16,460	100	2.400
TCMA06030	6 x 30 Ø6	24,667	100	2.400
TCMA06040	6 x 40 Ø6	27,693	100	1.200
TCMA06050	6 x 50 Ø6	31,847	100	1.200

ZA

Anclaje para cargas medias-altas en materiales macizos o huecos

ZA-CA

Cápsula



02 Info Técnica P. 370

MULTIMATERIAL

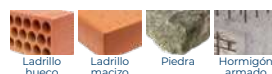

CÓDIGO	MEDIDA	€/100	LONGITUD CÁPSULA		
AZAMC06	M6 x 48 Ø12	127,703	48	100	1.200
AZAMC08	M8 x 50 Ø14	157,400	50	100	600
AZAMC10	M10 x 58 Ø16	202,630	58	50	300
AZAMC12	M12 x 72 Ø20	325,007	72	25	300
AZAMC16	M16 x 107 Ø25	667,567	107	25	150

ZA-TO

Tornillo



02 Info Técnica P. 370

MULTIMATERIAL



CÓDIGO	MEDIDA	€/100	LONGITUD CÁPSULA		
AZAMT06	M6 x 50 Ø12	164,950	48	100	600
AZAMT08	M8 x 60 Ø14	209,293	50	100	400
AZAMT10	M10 x 80 Ø16	298,327	58	50	200
AZAMT12	M12 x 100 Ø20	494,127	72	25	100
AZAMT16	M16 x 140 Ø25	1.098,647	107	25	50

ZA-TL

Tornillo largo



02 Info Técnica P. 370

MULTIMATERIAL



CÓDIGO	MEDIDA	€/100	MEDIDA TORNILLO		
ZT06L10	M6 x 60 Ø12	194,423	60	100	600
ZT06L30	M6 x 80 Ø12	213,087	80	100	600
ZT08L15	M8 x 70 Ø14	264,200	70	100	400
ZT08L35	M8 x 90 Ø14	274,410	90	100	400
ZT08L45	M8 x 100 Ø14	297,983	100	100	300
ZT10L10	M10 x 70 Ø16	421,637	70	50	200
ZT10L30	M10 x 90 Ø16	423,137	90	50	200
ZT10L50	M10 x 110 Ø16	405,810	110	50	200
ZT10L80	M10 x 140 Ø16	472,423	140	50	150
ZT12L15	M12 x 90 Ø20	639,123	90	25	100
ZT12L45	M12 x 120 Ø20	658,343	120	25	50
ZT12L65	M12 x 140 Ø20	720,880	140	25	100

ZA-PR

Tornillo largo + prolongador



02 Info Técnica P. 370

MULTIMATERIAL

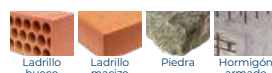

CÓDIGO	MEDIDA	€/100	LONGITUD PROLONGADOR		
ZP06C40	M6 x 90 Ø12	406,143	40	100	400
ZP08C15	M8 x 70 Ø14	410,407	15	100	200
ZP08C45	M8 x 100 Ø14	474,823	45	100	300
ZP10C50	M10 x 110 Ø16	665,500	50	50	100
ZP10C80	M10 x 140 Ø16	789,163	80	50	100
ZP12C15	M12 x 90 Ø20	845,753	15	25	100
ZP12C65	M12 x 140 Ø20	1.030,153	65	25	50

Anclaje para cargas medias-altas en materiales macizos o huecos

MULTIMATERIAL



CÓDIGO	MEDIDA	€/100	MEDIDA TORNILLO		
AZAME06	M6 x 60 Ø12	177,323	60	100	600
AZAME08	M8 x 70 Ø14	233,283	70	100	400
AZAME10	M10 x 100 Ø16	321,913	100	50	200
AZAME12	M12 x 120 Ø20	544,143	120	25	100
AZAME16	M16 x 140 Ø25	1.196,407	140	25	50

ZA-ES

Espárrago



02 Info. Técnica P. 370

MULTIMATERIAL

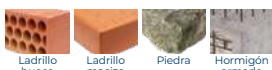

CÓDIGO	MEDIDA	€/100	APERTURA GANCHO		
AZAMG06	M6 x 45 Ø12	175,380	10	50	600
AZAMG08	M8 x 50 Ø14	247,347	13	50	300
AZAMG10	M10 x 56 Ø16	336,810	14	25	150
AZAMG12	M12 x 70 Ø20	549,583	22	25	100

ZA-GA

Gancho



02 Info. Técnica P. 371

MULTIMATERIAL

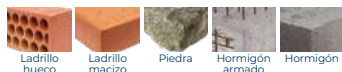

CÓDIGO	MEDIDA	€/100	APERTURA GANCHO		
AZAMGFO06	M6 x 45 Ø12	253,720	10	50	600
AZAMGFO08	M8 x 50 Ø14	368,517	11	50	300
AZAMGFO10	M10 x 56 Ø16	490,527	14	25	150
AZAMGFO12	M12 x 70 Ø20	796,190	18	25	75

ZA-GF

Gancho forjado



02 Info. Técnica P. 371

MULTIMATERIAL

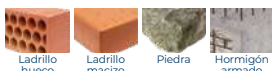

CÓDIGO	MEDIDA	€/100	Ø OJO		
AZAMA06	M6 x 45 Ø12	175,380	10	50	600
AZAMA08	M8 x 50 Ø14	247,347	13	50	300
AZAMA10	M10 x 56 Ø16	336,810	14	25	150
AZAMA12	M12 x 70 Ø20	549,583	22	25	100

ZA-AR

Argolla



02 Info. Técnica P. 371

MULTIMATERIAL



CÓDIGO	MEDIDA	€/100	Ø OJO		
AZAMAF006	M6 x 45 Ø12	252,453	10	50	600
AZAMAF008	M8 x 50 Ø14	340,550	12	50	300
AZAMAF010	M10 x 56 Ø16	452,843	14	25	150
AZAMAF012	M12 x 70 Ø20	724,470	17	25	100

ZA-AF

Argolla forjada



02 Info. Técnica P. 371

AC

Anclaje de acero con aletas para cargas altas

AC-CA

Cápsula



02 Info. Técnica P. 371

MACIZOS

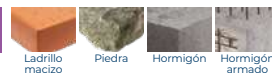

CÓDIGO	MEDIDA	€/100	LONGITUD CÁPSULA	UD. MIN. VENTA		
AACCA06	M6 x 40 Ø10	34,430	40	-	50	1.200
AACCA08	M8 x 50 Ø14	53,430	50	100	50	600
AACCA10	M10 x 60 Ø16	71,723	60	100	50	300
AACCA12	M12 x 80 Ø20	129,933	80	50	25	300
AACCA16	M16 x 100 Ø25	339,817	100	20	10	120

AC-CI

Cápsula. Inoxidable A4



02 Info. Técnica P. 371

INOXIDABLE

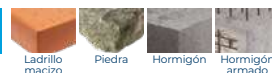

CÓDIGO	MEDIDA	€/100	LONGITUD CÁPSULA		
AACCI06	M6 x 40 Ø10	464,670	40	50	1.200
AACCI08	M8 x 50 Ø14	842,543	50	50	600
AACCI10	M10 x 60 Ø16	942,803	60	25	300
AACCI12	M12 x 80 Ø20	1.744,203	80	10	120

AC-TO

Tornillo 6.8



02 Info. Técnica P. 371

MACIZOS

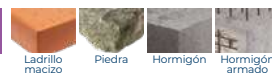

CÓDIGO	MEDIDA	€/100	LONGITUD TORNILLO		
AACTO06	M6 x 40 Ø10	53,657	50	50	600
AACTO08	M8 x 50 Ø14	92,370	60	50	300
AACTO10	M10 x 60 Ø16	136,420	70	50	200
AACTO12	M12 x 80 Ø20	261,157	100	25	100
AACTO16	M16 x 125 Ø25	613,450	120	10	30

AC-ES

Espárrago



02 Info. Técnica P. 372

MACIZOS

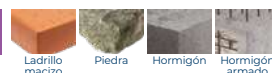

CÓDIGO	MEDIDA	€/100	LONGITUD ESPÁRRAGO		
AACES06	M6 x 40 Ø10	67,053	60	50	600
AACES08	M8 x 50 Ø14	102,430	70	50	300
AACES10	M10 x 60 Ø16	152,543	80	50	200
AACES12	M12 x 80 Ø20	305,957	115	25	100

AC-GA

Gancho



02 Info. Técnica P. 372

MACIZOS

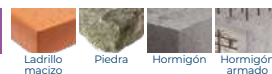

CÓDIGO	MEDIDA	€/100	APERTURA GANCHO		
AACGA06	M6 x 40 Ø10	110,880	10	50	600
AACGA08	M8 x 50 Ø14	154,400	11	50	300
AACGA10	M10 x 60 Ø16	233,967	14	50	100
AACGA12	M12 x 80 Ø20	405,437	18	25	50

AC-AR

Argolla



02 Info. Técnica P. 372

MACIZOS

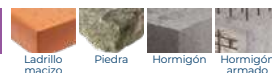

CÓDIGO	MEDIDA	€/100	Ø OJO		
AACAR06	M6 x 40 Ø10	106,210	10	50	600
AACAR08	M8 x 50 Ø14	142,907	12	50	300
AACAR10	M10 x 60 Ø16	219,120	14	50	200
AACAR12	M12 x 80 Ø20	368,000	17	25	100



Anclaje antigiro para cargas altas

HI

MACIZOS



CÓDIGO	MEDIDA	€/100	LONGITUD CÁPSULA		
AHICA0645	M6 x 45 Ø12	81,337	41	100	1.200
AHICA0855	M8 x 55 Ø14	90,653	45	50	600
AHICA1065	M10 x 65 Ø16	115,923	57	50	300
AHICA1275	M12 x 75 Ø20	155,590	70	25	150
AHICA1690	M16 x 90 Ø24	257,610	90	10	60

HI-CA

Cápsula



02
P. 372
Info.
Técnica

INOXIDABLE



CÓDIGO	MEDIDA	€/100	LONGITUD CÁPSULA		
AHICI0645	M6 x 45 Ø12	600,255	40	100	600
AHICI0855	M8 x 55 Ø14	843,040	48	50	600
AHICI1065	M10 x 65 Ø16	1.125,520	59	50	300

HI-CI

Cápsula. Inoxidable A2



02
P. 372
Info.
Técnica

MACIZOS



CÓDIGO	MEDIDA	€/100		
AHITO0645	M6 x 45 Ø12	100,700	100	600
AHITO0855	M8 x 55 Ø14	142,440	50	300
AHITO1065	M10 x 65 Ø16	201,297	50	200
AHITO1275	M12 x 75 Ø20	306,450	25	100
AHITO1690	M16 x 90 Ø24	568,107	10	40

HI-TO

Tornillo 8.8



02
P. 372
Info.
Técnica

MACIZOS



CÓDIGO	MEDIDA	€/100	APERTURA GANCHO		
AHIGA0645	M6 x 45 Ø12	158,913	10	100	400
AHIGA0855	M8 x 55 Ø14	232,313	11	50	300
AHIGA1065	M10 x 65 Ø16	344,433	14	50	100
AHIGA1275	M12 x 75 Ø20	534,877	18	25	75
AHIGA1690	M16 x 90 Ø24	1.041,737	19	10	30

HI-GA

Gancho



02
P. 372
Info.
Técnica

MACIZOS



CÓDIGO	MEDIDA	€/100	Ø OJO		
AHIAR0645	M6 x 45 Ø12	159,017	10	100	400
AHIAR0855	M8 x 55 Ø14	206,627	12	50	300
AHIAR1065	M10 x 65 Ø16	278,047	14	50	200
AHIAR1275	M12 x 75 Ø20	455,297	17	25	75
AHIAR1690	M16 x 90 Ø24	992,637	23	10	30

HI-AR

Argolla



02
P. 372
Info.
Técnica

EPS

Anclaje metálico para fijar marcos de puertas y ventanas

MULTIMATERIAL



02 Info Técnica P. 373

CÓDIGO	MEDIDA	€/100		ESPESOR MÁX. A FIJAR		
EPS6072	M6 x 72 Ø10	62,647	PZ3	40	100	600
EPS6092	M6 x 92 Ø10	75,787	PZ3	60	100	600
EPS6112	M6 x 112 Ø10	83,423	PZ3	80	100	200
EPS6132	M6 x 132 Ø10	93,710	PZ3	100	100	200
EPS6152	M6 x 152 Ø10	106,233	PZ3	120	100	400
EPS6182	M6 x 182 Ø10	134,963	PZ3	150	100	300

TRA

Taco elástico para la fijación de rastreles

MACIZOS

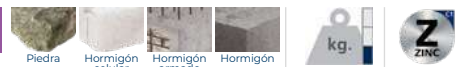

02 Info Técnica P. 373

CÓDIGO	MEDIDA	€/100	ESPESOR MÁX. A FIJAR		
TRA6050	6 x 50 Ø6	19,480	20	200	2.400
TRA6060	6 x 60 Ø6	20,977	30	200	1.200
TRA6080	6 x 80 Ø6	23,317	50	200	1.200
TRA8070	8 x 70 Ø8	31,133	30	100	1.200
TRA8090	8 x 90 Ø8	36,790	50	100	600
TRA8110	8 x 110 Ø8	42,633	70	100	600
TRA8130	8 x 130 Ø8	56,023	90	100	600
TRA8150	8 x 150 Ø8	62,807	110	100	600

Blíster

CÓDIGO	MEDIDA	€/BOLSA	PCS.	BOLSAS
BZTRA6050	6 x 50 Ø6	3,427	10	15
BZTRA6060	6 x 60 Ø6	3,427	10	15
BZTRA6080	6 x 80 Ø6	3,427	10	15
BZTRA8070	8 x 70 Ø8	3,427	10	15
BZTRA8090	8 x 90 Ø8	4,622	10	15
BZTRA8110	8 x 110 Ø8	4,622	10	12
BZTRA8130	8 x 130 Ø8	4,622	8	12
BZTRA8150	8 x 150 Ø8	4,622	8	12

AV

Anclaje para fachadas ventiladas

AVR

Roscado

INOXIDABLE



CÓDIGO	MEDIDA	€/100		
AVR08120	M8 x 120 Ø8	311,053	100	600
AVR08150	M8 x 150 Ø8	344,967	100	600
AVR10120	M10 x 120 Ø10	388,977	100	400
AVR10150	M10 x 150 Ø10	445,140	100	200
AVR10180	M10 x 180 Ø10	495,263	100	200

AVC

Corrugado

INOXIDABLE



CÓDIGO	MEDIDA	€/100		
AVC08120	8 x 120 Ø8	335,017	100	600
AVC08150	8 x 150 Ø8	375,020	100	600
AVC10120	10 x 120 Ø10	428,867	100	400
AVC10150	10 x 150 Ø10	491,217	100	200
AVC10180	10 x 180 Ø10	554,563	100	200



Anclaje para andamios y fachadas

ANFA

MULTIMATERIAL



CÓDIGO	MEDIDA	€/100	Ø TACO	PROFUNDIDAD MÍN. DE TALADRO	PROFUNDIDAD MÍN. DEL ANCLAJE	Ø OJO		
ANFA2309	12 x 90 Ø14-Ø16	209,067	TC-SO Ø14-Ø16	100	90	23	20	120
ANFA2312	12 x 120 Ø14-Ø16	238,197	TC-SO Ø14-Ø16	130	120	23	20	80
ANFA2316	12 x 160 Ø14-Ø16	288,697	TC-SO Ø14-Ø16	170	160	23	20	60
ANFA2319	12 x 190 Ø14-Ø16	311,297	TC-SO Ø14-Ø16	200	190	23	20	60
ANFA2323	12 x 230 Ø14-Ø16	358,557	TC-SO Ø14-Ø16	240	230	23	20	40
ANFA2330	12 x 300 Ø14-Ø16	491,730	TC-SO Ø14-Ø16	310	300	23	10	20
ANFA2335	12 x 350 Ø14-Ø16	535,263	TC-SO Ø14-Ø16	360	350	23	10	-

* Taco recomendado TCSO16140

MULTIMATERIAL



CÓDIGO	MEDIDA	€/100	Ø TACO	PROFUNDIDAD MÍN. DE TALADRO	PROFUNDIDAD MÍN. DEL ANCLAJE	Ø OJO		
ANFA5114	12 x 140 Ø14-Ø16	371,063	TC-SO Ø14-Ø16	150	140	51	20	60
ANFA5116	12 x 160 Ø14-Ø16	405,077	TC-SO Ø14-Ø16	170	160	51	20	40
ANFA5120	12 x 200 Ø14-Ø16	524,637	TC-SO Ø14-Ø16	210	200	51	20	40
ANFA5124	12 x 240 Ø14-Ø16	577,930	TC-SO Ø14-Ø16	250	240	51	20	40

* Taco recomendado TCSO16140

MULTIMATERIAL



CÓDIGO	MEDIDA	€/100	PROFUNDIDAD MÍN. DE TALADRO	Ø OJO		
ANFAZ5021	M10 x 210 Ø16	1.210,473	120	50	10	20

MULTIMATERIAL



CÓDIGO	MEDIDA	€/100		
TCSO14075	14 x 75 Ø14	27,137	20	240
TCSO14100	14 x 100 Ø14	34,986	20	240

MULTIMATERIAL



CÓDIGO	MEDIDA	€/100		
TCSO14130	14 x 130 Ø14	69,432	20	240
TCSO14160	14 x 160 Ø14	78,222	20	120
TCSO16140	16 x 140 Ø16	153,209	20	120
TCSO16160	16 x 160 Ø16	163,142	20	80
TCSO16200	16 x 200 Ø16	168,439	20	60
TCSO16240	16 x 240 Ø16	191,504	20	40

MULTIMATERIAL



CÓDIGO	MEDIDA	€/100	Ø BROCA	PROFUNDIDAD MÍN. DE TALADRO	PROFUNDIDAD MÍN. DEL ANCLAJE		
ANFATA37B	13 x 37 Ø6	27,027	6	130	33	100	600
ANFATA70B	13 x 70 Ø6	32,555	6	180	33	100	300

AN-23

Diámetro de ojo 23 mm



02 Info. Técnica P. 376

AN-51

Diámetro de ojo 51 mm



02 Info. Técnica P. 377

AN-50 CT

Diámetro de ojo 50 mm + cápsula Zamak M10



02 Info. Técnica P. 377

TC-SO 2

Taco de nylon. 2 alas



TC-SO 8

Taco de nylon. 8 alas



AN-TA

Tapón tapa-agujeros





























FIJACIONES QUÍMICAS



TABLA DE SELECCIÓN

										
	Polyester Universal	Polyester PLUS	Polyester PLUS sin estireno	Polyester PLUS sin estireno. Piedra	Vinylester	Vinylester sin estireno	Resina híbrida sin estireno	Resina híbrida sin estireno. winter	Epoxy puro 1:1	Epoxy puro 3:1
	MO-PU	MO-P+	MO-PS+	MO-PSP+	MO-V	MO-VS	MO-H	MO-HW	MOPURE	MOPUR3

 opción 1							•	•	•	•
 opción 7	•	•	•	•	•	•				
 						•	•		•	•
 			•	•		•	•	•		
										•
							•	•	•	
							•	•		•
									•	
	•	•	•		•	•	•		•	•
	•	•	•		•	•	•		•	•
							•	•		•
			•	•		•	•	•		
	•	•	•	•	•	•	•	•	•	•
							•		•	•
						•	•		•	•
	•	•	•	•		•	•	•		
	•	•	•	•	•	•	•	•		
	•	•	•	•		•	•	•		
	•	•	•	•	•	•	•	•	•	•
	•	•	•	•	•	•	•	•	•	•
	•	•	•	•	•	•	•	•		•
								•		
	•	•	•	•	•	•	•		•	•

Fijaciones químicas

QUÍMICOS

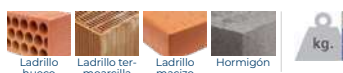

CÓDIGO	MEDIDA	€/1PC	kg.
MOPU300	300 ml.	14,478	12
MOPU410	410 ml.	17,508	12



MO-PU

Polyester universal. Homologado ETE Opt.7



QUÍMICOS

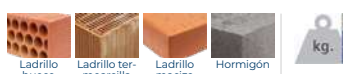

CÓDIGO	MEDIDA	€/1PC	kg.
MOP300	300 ml.	15,224	12
MOP410	410 ml.	17,987	12



MO-P+

Polyester PLUS. Homologado ETE Opt.7



QUÍMICOS



CÓDIGO	MEDIDA	€/1PC	kg.
MOPS300	300 ml.	17,781	12
MOPS410	410 ml.	22,408	12

KIT MO-PS

MOPS300EP	300 ml.	29,507	1
-----------	---------	--------	---

Contenido del KIT:

- Cartucho MOPS300 (300 ml.) - x1
- Cánulas MORCANU x2
- Espárragos MOCOSOP110 (M8 x 110 Ø8) - x4
- Tamices Nylon MOTN15035 (15 x 85) - x4

Ver video



¿Sabes hasta cuándo se puede manipular un anclaje químico ya aplicado?

El novedoso TESTIGO DE MANIPULADO incorporado en el MO-PS+ se trata de una tecnología única en el mercado. La resina cambia de color cuando inicia el proceso de curado, de azul a gris. Mientras se mantiene el tono azulado, el espárrago o varilla aplicada se puede manipular.



M8-M24



QUÍMICOS

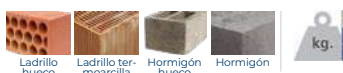

CÓDIGO	MEDIDA	€/1PC	kg.
MOPSP300	300 ml.	19,397	12
MOPSP410	410 ml.	24,444	12



MO-PSP+

Polyester PLUS sin estireno color piedra. Homologado ETE Opt.7



MO-AC

Accesorios para fijaciones químicas

MO-V

Vinylester.
Homologado ETE
Opt.7.



QUÍMICOS



CÓDIGO	MEDIDA	€/1PC	
MOV300	300 ml.	19,047	12
MOV410	410 ml.	23,084	12



M8-M24



MO-VS

Vinylester sin estireno.
Homologado ETE
Opt.7



QUÍMICOS



CÓDIGO	MEDIDA	€/1PC	
MOVS300	300 ml.	22,049	12
MOVS410	410 ml.	27,045	12

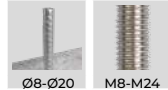

Ø8-Ø20 M8-M24



MO-H

Híbrida sin estireno.
Homologado ETE Opt.1



QUÍMICOS

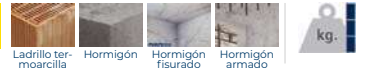

CÓDIGO	MEDIDA	€/1PC	
MOH300	300 ml.	25,961	12
MOH410	410 ml.	30,200	12



Ø8-Ø25 Ø8-Ø32 M8-M30



MO-HW

Híbrida sin estireno
versión WINTER.
Homologado ETE Opt.1



QUÍMICOS



CÓDIGO	MEDIDA	€/1PC	
MOHW300	300 ml.	27,258	12
MOHW410	410 ml.	31,990	12



Ø8-Ø32 M8-M30



QUÍMICOS

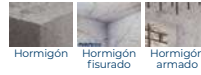

CÓDIGO	MEDIDA	€/1PC	kg
MOPURE600	600 ml.	77,068	12



MOPURE

Epoxy Puro 1:1. Homologado ETE Opt.1



QUÍMICOS



CÓDIGO	MEDIDA	€/1PC	kg
MOPUR30385	385 ml.	55,804	12
MOPUR30585	585 ml.	74,731	12



MOPUR3

Epoxy puro 3:1. Homologado ETE Opt.1



INDEXmor CLOUD

SOFTWARE ONLINE PARA CALCULO DE MORTEROS QUÍMICOS

El software permite realizar el cálculo online de cuántos cartuchos serán necesarios utilizar en función de los parámetros introducidos, tanto en ladrillo como en hormigón (varilla métrica y barra corrugada).

Parámetros en Hormigón:

- Selección de elemento a instalar (Varilla métrica o barra corrugada).
- Número de taladros a rellenar.
- Selección de métrica (M8 - M32).
- Profundidad del taladro.
- Aprovechamiento del cartucho (óptima, buena, pobre).

Parámetros en Ladrillo:

- Número de taladros a rellenar.
- Selección de métrica (M8 - M12).
- Posibilidad de incluir tamiz roscado en el cálculo.

Prestaciones:

- Software 100% online.
- Facilidad de uso. Responsive design.
- Multilingüe: disponible en castellano, inglés, francés, alemán y portugués.



MO

Fijaciones químicas

MO-PIS

Pistolas aplicadoras



CÓDIGO	MODELO	MEDIDA CARTUCHO	€/1 PC	
MOPISTO	Manual	410 ml.	47,267	1
MOPISPR	Profesional	410 ml.	116,736	1
MOPISSI	Silicona	170ml. / 300 ml.	27,045	1
MOPISPUR6	MOPURE600	600 ml.	63,702	1
MOPISNEU	Neumática	410 ml.	1.545,829	1
MOPISP3385	385 ml.	385 ml.	128,879	1
MOPISP3585	585 ml.	585 ml.	146,358	1

MO-TN

Tamiz de plástico



CÓDIGO	MEDIDA	€/100	UD. MIN. VENTA		
MOTN12050	12 x 50	43,457	24	12	2256
MOTN12080	NEW 12 x 80	38,593	24	12	2256
MOTN15085	15 x 85	38,213	24	12	1500
MOTN15130	15 x 130	45,073	24	12	1008
MOTN20085	20 x 85	43,487	24	12	1008

Bolsa Autoservicio

CÓDIGO	MEDIDA	€/BOLSA	PCS.	BOLSAS
LSMOTN12050	12 x 50	3,014	4	7
LSMOTN15085	15 x 85	3,003	4	6
LSMOTN20085	20 x 85	2,652	2	6

MO-TR

Tamiz roscado



CÓDIGO	MEDIDA	€/100		
MOTR008	M8 x 80 Ø12	222,763	12	540
MOTR010	M10 x 80 Ø14	298,420	12	288
MOTR012	M12 x 80 Ø16	361,320	12	288

MO-AC

Cánulas mezcladoras y varios

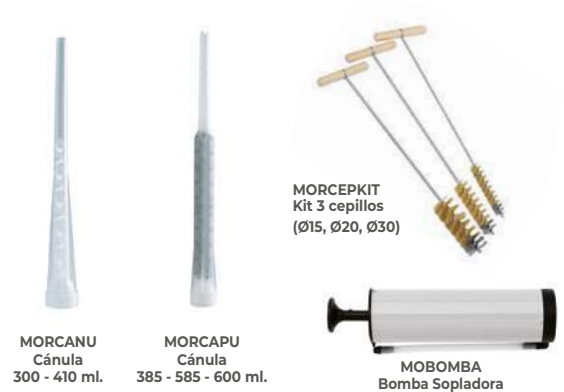

CÓDIGO	MODELO	€/1 PC		
MOBOMBA	Bomba Sopladora	15,920	1	1
MORCANU	Cánula 300 - 410 ml.	1,034	12	1008
MORCAPU	Cánula 385 - 585 - 600 ml.	1,582	12	24
MORCEPKIT	Kit Cepillo	77,064	1	1

MO-ES

Espárrago roscado



CÓDIGO	MEDIDA	€/100		
MOES06070	M6 x 70 Ø6	64,533	12	540
MOES08110	M8 x 110 Ø8	109,217	12	288
MOES10115	M10 x 115 Ø10	145,060	12	144
MOES12110	M12 x 110 Ø12	193,273	12	144

Bolsa Autoservicio

CÓDIGO	MEDIDA	€/BOLSA	PCS.	BOLSAS
LSMOES06070	M6 x 70 Ø6	4,649	4	10
LSMOES08110	M8 x 110 Ø8	6,633	4	7
LSMOES10115	M10 x 115 Ø10	8,183	4	6
LSMOES12110	M12 x 110 Ø12	10,278	4	6

MO-TM

Tamiz metálico



CÓDIGO	MEDIDA	€/100		
MOTM12100	12 x 1000 Ø11	1.938,787	10	-
MOTM16100	16 x 1000 Ø14	2.195,560	10	-
MOTM22100	22 x 1000 Ø21	2.578,860	5	20



Resina de epoxi-acrilato, cuarzo y catalizador.
Homologado ETE Opción 8

CA-QU

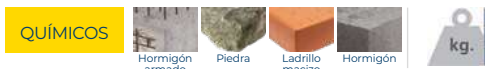

CÓDIGO	MEDIDA	€/100		
CAQU008	8 x 80 Ø10	197,283	10	500
CAQU010	10 x 90 Ø12	201,817	10	500
CAQU012	12 x 110 Ø14	210,423	10	200
CAQU016	16 x 125 Ø18	233,947	10	200

CÓDIGO	MEDIDA	€/100		
CAQU020	20 x 170 Ø25	476,007	6	60
CAQU024	24 x 210 Ø28	557,323	6	60
•CAQU030	30 x 280 Ø35	993,820	6	30

• Medidas sin homologar

INDEX CAQU012

02 Info Técnica p. 377



Espárragos con tuerca y arandela para anclaje químico

EQ



CÓDIGO	MEDIDA	€/100		
EQAC08110	M8 x 110	91,040	10	240
EQAC10130	M10 x 130	146,253	10	120
EQAC10190	NEW M10 x 190	229,045	10	30
EQAC12160	M12 x 160	233,143	10	120
EQAC12220	NEW M12 x 220	353,265	10	30
EQAC16190	M16 x 190	441,927	10	40

CÓDIGO	MEDIDA	€/100		
EQAC16250	NEW M16 x 250	637,386	10	30
EQAC20260	M20 x 260	955,723	6	12
EQAC20350	NEW M20 x 350	1.401,619	6	-
EQAC24300	M24 x 300	1.452,567	6	12
EQAC24380	NEW M24 x 380	2.317,808	6	-
EQAC30330	M30 x 330	3.017,783	6	12

EQ-AC

Cincado



CÓDIGO	MEDIDA	€/100		
EQ8808110	M8 x 110	95,592	10	240
EQ8810130	M10 x 130	153,566	10	120
EQ8812160	M12 x 160	240,498	10	60

CÓDIGO	MEDIDA	€/100		
EQ8816190	M16 x 190	388,592	6	24
EQ8820260	M20 x 260	809,847	6	24
EQ8824300	M24 x 300	1.295,507	6	12

EQ-8.8 NEW

Cincado 8.8



CÓDIGO	MEDIDA	€/100		
EQA208110	M8 x 110	310,533	10	240
EQA210130	M10 x 130	513,190	10	120
EQA212160	M12 x 160	850,517	10	120
EQA216190	M16 x 190	1.762,247	10	40

CÓDIGO	MEDIDA	€/100		
EQA220260	M20 x 260	3.368,117	6	12
EQA224300	M24 x 300	5.382,437	6	12
EQA230330	M30 x 330	9.820,060	6	12

EQ-A2

Inoxidable A2



CÓDIGO	MEDIDA	€/100		
EQA408110	M8 x 110	356,573	10	240
EQA410130	M10 x 130	647,677	10	120
EQA412160	M12 x 160	1.114,120	10	120
EQA416190	M16 x 190	2.297,417	10	40

CÓDIGO	MEDIDA	€/100		
EQA420260	M20 x 260	5.313,967	6	12
EQA424300	M24 x 300	8.758,463	6	12
EQA430330	M30 x 330	15.449,990	6	12

EQ-A4

Inoxidable A4



Tabla de selección



	MSPRB290	MSPRG290	MSPRM290	MSPRN290	MSTR290	MSSF290
	•	•	•	•		
	•	•	•	•		•
	•	•	•	•	•	•
	•	•	•	•	•	•
	•	•	•	•		
	•	•	•	•	•	•
	•	•	•	•	•	•
	•	•	•	•	•	•
	•	•	•	•	•	•
	•	•	•	•	•	•
	•	•	•	•	•	•
	•	•	•	•	•	•
	300 %	300 %	300 %	300 %	250 %	200 %
	150 kg/10 cm ²	150 kg/10 cm ²	150 kg/10 cm ²	150 kg/10 cm ²	140 kg/10 cm ²	430 kg/10 cm ²
	•	•	•	•	•	•
	•	•	•	•	•	•
	•	•	•	•	•	•
					•	
						•

Adhesivos Hybrid MS Polymer



CÓDIGO	COLOR	290 ml.	€/PC	12
MSPRB290	○	290 ml.	11,399	12
MSPRG290	●	290 ml.	11,399	12
MSPRM290	●	290 ml.	11,399	12
MSPRN290	●	290 ml.	11,399	12

APLICACIONES

- Pegado y sellado en construcción: repisas, remates en tejado, canalones, cubiertas, juntas de marcos o estructuras sometidas a vibraciones. Sellado y pegado en industria y automóvil.
- Relleno de grietas.
- Sellado de juntas de dilatación, cisternas, contenedores y otros elementos de aluminio.
- Producto certificado para el uso en la industria de procesamiento de alimentos (Certificado ISEGA).
- Adhesión a todo tipo de materiales: hormigón, madera, metal, corcho, aluminio, PVC, cobre, ladrillo, piedra, porcelana... No recomendado para Polietileno (PE), Polipropileno (PP) y Politetrafluoroetileno (PTFE).
- En caso de no conocer el material base se deberán realizar unas pruebas previas para garantizar el buen funcionamiento del producto.

MS-PR

Adhesivo MS Professional



CÓDIGO	COLOR	290 ml.	€/PC	12
MSTR290	⊗	290 ml.	16,131	12

APLICACIONES

- Incoloro. Adecuado para el pegado de vidrio, cristal, acrílico, PVC, porcelana, cerámica y otros elementos transparentes en interior o exterior.
- Fijación de materiales con una unión transparente o visible.
- Apto para aplicación sobre superficies húmedas.
- Adhesión a todo tipo de materiales (hormigón, madera, metal, corcho, aluminio, PVC, cobre, ladrillo, piedra, porcelana...). No recomendado para Polietileno (PE), Polipropileno (PP) y Politetrafluoroetileno (PTFE).
- En caso de no conocer el material base se deberán realizar unas pruebas previas para garantizar el buen funcionamiento del producto.
- Apto para montar y pegar.

MS-TR

Adhesivo MS Transparente

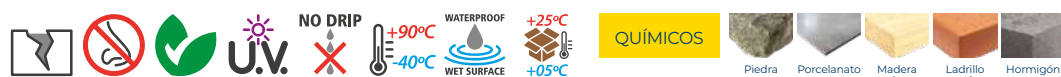
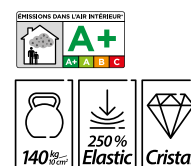

CÓDIGO	COLOR	290 ml.	€/PC	12
MSSF290	○	290 ml.	13,677	12

APLICACIONES

- Especialmente indicado para el pegado y conexión rápida de elementos pesados sin fijaciones adicionales. Triplica las prestaciones de agarre de otros adhesivos.
- Apto para usar en interior y exterior. Resistente a rayos UV.
- Adhesión a todo tipo de materiales: hormigón, madera, metal, corcho, aluminio, PVC, cobre, ladrillo, piedra, porcelana... No recomendado para Polietileno (PE), Polipropileno (PP) y Politetrafluoroetileno (PTFE).
- En caso de no conocer el material base se deberán realizar unas pruebas previas para garantizar el buen funcionamiento del producto.

MS-SF

Adhesivo MS Superfast High Tack



Tabla de selección

	SI-PR					SI-PRS		SI-UNI					SI-UNS		SE-ACR		
	SIPRB280	SIPRG280	SIPRM280	SIPRN280	SIPRT280	SIPRSB280	SIPRST280	SIUNIB280	SIUNIG280	SIUNIM280	SIUNIN280	SIUNIT280	SIUNSB280	SIUNST280	SEACRB280	SEACRG280	
	•	•	•	•	•	•	•	•	•	•	•	•	•	•	•	•	
	•	•	•	•	•	•	•	•	•	•	•	•	•	•	•	•	
							•	•	•	•	•	•	•	•	•	•	
	•	•	•	•	•	•	•	•	•	•	•	•	•	•	•	•	
	•	•	•	•	•	•	•	•	•	•	•	•	•	•	•	•	
	•	•	•	•	•	•	•	•	•	•	•	•	•	•	•	•	
	•	•	•	•	•	•	•	•	•	•	•	•	•	•	•	•	
	•	•	•	•	•	•	•	•	•	•	•	•	•	•	•	•	
															•	•	
	•	•	•	•	•	•	•	•	•	•	•	•	•	•	•	•	
	•	•	•	•	•	•	•	•	•	•	•	•	•	•	•	•	
	•	•	•	•	•	•	•	•	•	•	•	•	•	•	•	•	
	•	•	•	•	•	•	•	•	•	•	•	•	•	•	•	•	
					•									•			
						•	•							•	•		
						•	•							•	•		
	•	•	•	•	•												
	•	•	•	•	•	•	•										
																•	•
																•	•

Nueva gama de siliconas

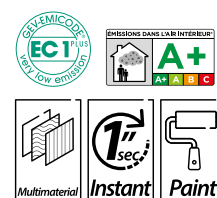

Sellantes, aislantes y aplicables a distintas superficies en interior y también en exteriores

La gama de siliconas INDEX® está disponible en una variedad de colores y propiedades para adaptarse a las necesidades de cada aplicación. Todas las siliconas son resistentes al agua y adaptables a distintos materiales lo que las convierte en una solución profesional para el montaje y sellado de juntas en diferentes superficies.

SI

Siliconas

SI-PR

Silicona Neutra Profesional para materiales lisos y porosos

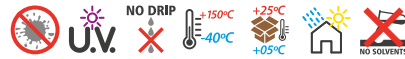

CÓDIGO	COLOR		€/PC	
SIPRB280	○	280 ml	13,656	12
SIPRG280	●	280 ml.	13,656	12
SIPRM280	●	280 ml.	13,656	12
SIPRN280	●	280 ml.	13,656	12
SIPRT280	●	280 ml.	13,656	12

CARACTERÍSTICAS

- Elásticas y flexibles
- Apto para aplicación en ventanas
- Disponible en colores blanco, negro, marrón (RAL 8016), gris (RAL 7030) y transparente
- Multimaterial: aptas para su uso en carpintería de aluminio y PVC, juntas de dilatación, hormigón, ladrillos, piedra, madera, metales y vidrio)
- Certificado A+ sobre emisiones en interiores

SI-PRS

Silicona Neutra SANITAR Profesional con propiedades fungicidas



CÓDIGO	COLOR		€/PC	
SIPRSB280	○	280 ml.	13,656	12
SIPRST280	⊗	280 ml.	13,656	12

CARACTERÍSTICAS

- Contienen fungicidas para evitar la aparición de moho
- Aptas para la aplicación en baños y cocinas
- Elásticas y flexibles
- Aptas para la aplicación en ventanas
- Disponible en color blanco y transparente
- Multimaterial: aptas para su uso en carpintería de aluminio y PVC, juntas de dilatación, hormigón, ladrillos, piedra, madera, metales y vidrio)

SI-UNI

Silicona acética universal multiusos

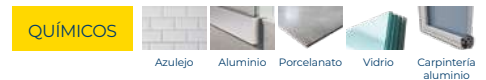
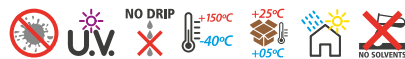

CÓDIGO	COLOR		€/PC	
SIUNIB280	○	280 ml.	9,938	12
SIUNIG280	●	280 ml.	9,938	12
SIUNIM280	●	280 ml.	9,938	12
SIUNIN280	●	280 ml.	9,938	12
SIUNIT280	⊗	280 ml.	9,938	12

CARACTERÍSTICAS

- Multiusos: apto para su uso en aluminio, cerámica, vidrio y porcelana
- No aptas para materiales porosos, oxidables o atacables por ácidos
- Elásticas y flexibles
- Apto para aplicación en interior y exterior



Siliconas

SI

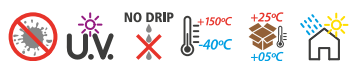

QUÍMICOS

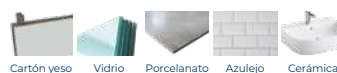

CÓDIGO	COLOR		€/PC	
SIUNSB280		280 ml.	9,938	12
SIUNST280		280 ml.	9,938	12

CARACTERÍSTICAS

- Contienen fungicidas para evitar la aparición de moho
- Aptas para la aplicación en baños y cocinas
- Elásticas y flexibles
- Aptas para la aplicación en ventanas
- Disponible en color blanco y transparente
- Multiusos: Aptas para su uso en aluminio, cerámica, vidrio y porcelana.
- No aptas para materiales porosos, oxidables o atacables por ácidos

SI-UNS

Silicona acética SANITAR universal multiusos con propiedades fungicidas

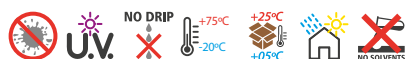

QUÍMICOS

CÓDIGO	COLOR		€/PC	
SEACRB280		280 ml.	4,726	12
SEACRG280		280 ml.	4,726	12

CARACTERÍSTICAS

- Apta para el sellado de todo tipo de juntas, pequeños agujeros, grietas en fachada, pared, ranuras en cajas de persianas, marcos de puertas y ventanas
- Apta para aplicación en materiales porosos (Hormigón, madera, baldosas de cerámica, placas de yeso) y para la reparación de pequeñas grietas
- Flexible y alta adherencia
- Se puede pintar y barnizar
- Muy fácil de aplicar
- Apto para aplicación en interior y exterior

SE-ACR

Masilla acrílica para juntas y grietas



Cánulas para MS y Siliconas

MS-CA



MSCAHT



MSCATP

CÓDIGO	MODELO	VÁLIDO PARA	€/BOLSA	PCS.	BOLSAS
MSCATP	TAPON	MS-PR, MS-TR y Siliconas	13,335	12	18
MSCAHT	ANCHA	MS-SF	13,973	12	18

PU-S

Espuma de poliuretano multiusos

PU-SP

Para aplicación con pistola



QUÍMICOS



CÓDIGO	MEDIDA	€/1PC	GRADO INFLAMACIÓN	TEMPERATURA DE SERVICIO	
PUSP750	750 ml.	15,046	EN 13501, parte 1 (E)	-40°C a +90°C	12

PU-SC

Para aplicación con cánula



QUÍMICOS



CÓDIGO	MEDIDA	€/1PC	GRADO INFLAMACIÓN	TEMPERATURA DE SERVICIO	
PUSC750	750 ml.	14,305	EN 13501, parte 1 (E)	-40°C a +90°C	12



NUEVA CÁNULA ECOFLEX

Su novedoso sistema de bloqueo permite conservar y reutilizar el producto varios días, permitiendo no desperdiciar producto y ser más respetuoso con el medioambiente.

PU-T

Espuma de poliuretano para fijación de tejas

PU-TP

Para aplicación con pistola.
Color gris



QUÍMICOS



CÓDIGO	MEDIDA	€/1PC	GRADO INFLAMACIÓN	TEMPERATURA DE SERVICIO	
PUTP750	750 ml.	15,859	EN 13501, parte 1 (E)	-40°C a +90°C	12



NEW PU-TPR

Para aplicación con pistola.
Color teja



QUÍMICOS



CÓDIGO	MEDIDA	€/PC	
PUTPR750	750 ml.	15,859	12





Espuma de poliuretano para fijación de tejas

PU-T

QUÍMICOS



CÓDIGO	MEDIDA	€/1PC	GRADO INFLAMACIÓN	TEMPERATURA DE SERVICIO	
PUTC750	750 ml.	15,380	EN 13501, parte 1 (E)	-40°C a +90°C	12



PU-TC

Para aplicación con cánula.
Color gris



Espuma de poliuretano resistente al fuego

PU-F

QUÍMICOS



CÓDIGO	MEDIDA	€/1PC	GRADO INFLAMACIÓN	TEMPERATURA DE SERVICIO	
PUFP750	750 ml.	26,970	DIN 4102, parte 1 (B1); B5 476, parte 20; EN 13501, parte 1 (B-s1, d0); EN 13501, parte 2 (EI 240)	-40°C a +90°C	12



PU-FP

Para aplicación con pistola



QUÍMICOS



CÓDIGO	MEDIDA	€/1PC	GRADO INFLAMACIÓN	TEMPERATURA DE SERVICIO	
PUFC750	750 ml.	26,158	DIN 4102, parte 1 (B1); B5 476, parte 20; EN 13501, parte 1 (B-s1, d0); EN 13501, parte 2 (EI 240)	-40°C a +90°C	12



PU-FC

Para aplicación con cánula



NUEVA CÁNULA ECOFLEX

Su novedoso sistema de bloqueo permite conservar y reutilizar el producto varios días, permitiendo no desperdiciar producto y ser más respetuoso con el medioambiente.

Adhesivo de poliuretano SATE para paneles aislantes y placas de yeso laminado

PU-EP

QUÍMICOS



CÓDIGO	MEDIDA	€/1PC	GRADO INFLAMACIÓN	TEMPERATURA DE SERVICIO	
PUEP750	750 ml.	24,875	EN 13501-1 (E)	-40°C a +90°C	12

ASSESSED ACCORDING TO
ETAG 004



PU-EP

Para aplicación con pistola



PU-AC

Accesorios para espumas de poliuretano

PU-PI

Profesional



CÓDIGO	MODELO	MEDIDA CARTUCHO	€/1 PC	
PUPI01	750 ml.	750 ml.	99,306	1

PU-PI 2

Básica



CÓDIGO	MODELO	MEDIDA CARTUCHO	€/1 PC	
PUPI02	750 ml.	750 ml.	37,853	1

PU-CA

Cánula



CÓDIGO	MEDIDA CARTUCHO	€/BOLSA	PCS.	BOLSAS
PUCA01	750 ml.	5,345	12	18

PU-CL

Limpiador de accesorios para la aplicación de espuma de poliuretano



CÓDIGO	MEDIDA	€/1 PC	
PUCL500	500 ml.	15,602	12



FIJACIONES PLÁSTICAS



T-NUX

Los tacos de nylon universales de alto rendimiento para uso en hormigón y mampostería, son una solución polivalente y profesional. Permiten su instalación con las máximas garantías de seguridad gracias a que cuentan con homologación ETE y a resistencia a fuego.

Su diseño permite que el taco logre adaptarse a cualquier tipo de material base, ya sea en material sólido o hueco. Además, posibilita que la carga se distribuya a lo largo de todo el taco, gracias a una expansión controlada en distintos puntos del material donde se instala.



DISEÑO Y GEOMETRÍA

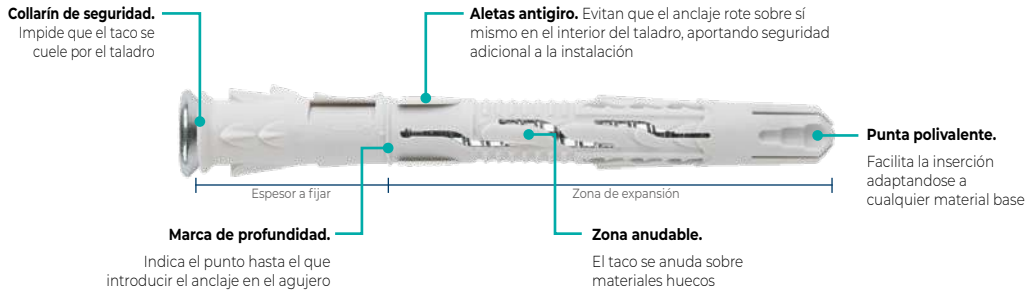

APLICACIONES

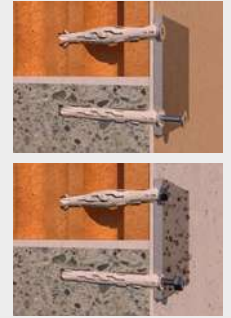

- Fijación de marcos de ventanas y puertas.
- Puertas de garajes.
- Barandillas.
- Balaustradas.
- Fijación de rejillas.
- Rehabilitación de fachadas.
- Fijación de subestructuras metálicas para fachadas ventiladas.
- Usos exteriores e interiores.
- Fijación de aplacados de piedra para revestimientos de fachada.

CUALIDADES Y VENTAJAS



MÁXIMA VERSATILIDAD. MULTIMATERIAL.

Su diseño permite que el taco logre adaptarse a cualquier tipo de material base, ya sea en materiales macizos o huecos. Especialmente apto para cuando se desconozca el material base donde se realiza la fijación.

MÁXIMAS GARANTÍAS. PRODUCTOS HOMOLOGADOS ACORDE A LOS MÁS ALTOS ESTÁNDARES DE CALIDAD.

- Homologado (ETA 14/0467) para usos no estructurales en hormigón, hormigón aireado, ladrillo macizo, ladrillo hueco y bloque de hormigón (en las medidas Ø8 y Ø10)
- Homologado a resistencia a fuego R30-R120 en hormigón



*El anclaje está homologado cuando se utiliza el taco y el tornillo en su conjunto, no por separado. Utilizar anclajes homologados aporta seguridad y calidad al anclaje cumpliendo los más altos estándares de calidad.



PRODUCTO DE CALIDAD

El anclaje T-NUX está compuesto de dos elementos de máxima calidad, un taco de nylon de Poliamida 6 y un tornillo (ver diferentes alternativas en la gama. También disponible el taco suelto).



MÁXIMAS PRESTACIONES

La geometría del taco permite que al introducir el tornillo, el taco expanda de una manera uniforme y permita una fijación con unas altas prestaciones de hasta 202 Kg por anclaje (consultar ficha técnica).

FABRICACIÓN 100% INDEX

Esto nos permite asegurar un riguroso control de los procesos, garantizar la máxima calidad en nuestros productos, brindar el mejor servicio y obtener un coste global competitivo.

GAMA



PRODUCTO	T-NUX A	T-NUX A A4	T-NUX E	T-NUX E A4	T-NUX T	T-FUX E	T-NUX
CABEZA DEL TORNILLO	Avellanada	Avellanada	Hexagonal	Hexagonal	Truss inviolable	Hexagonal sin arandela	Espárrago
RECUBRIMIENTO/MATERIAL DEL TORNILLO	Z	A4 INOX	Z	A4 INOX	Z	Z	-
TIPO DE CABEZA DEL TACO							
CE	✓	✓	✓	✓	✓	✓	
FIRE RESISTANCE	✓	✓	✓	✓	✓	✓	

EL RECUBRIMIENTO PERFECTO SEGÚN EL NIVEL DE CORROSIÓN



Material Inoxidable A4: válido para interior y exterior, en zonas costeras o industriales, zonas expuestas a alta contaminación o zonas cercanas a carreteras.



Recubrimiento Cincado: apto para uso en condiciones interiores secas (categoría C1 según la norma ISO 923), por un periodo de 50 años.

Taco de nylon universal de alto rendimiento

T-NUX



CÓDIGO	MEDIDA	€/100		ESPESOR MÁX. A FIJAR		
• TNUXA08060	8 x 60 Ø8	55,730	TX30	-	50	600
• TNUXA08080	8 x 80 Ø8	61,000	TX30	10	50	600
• TNUXA08100	8 x 100 Ø8	76,253	TX30	30	50	600
• TNUXA08120	8 x 120 Ø8	87,190	TX30	50	50	300
• TNUXA10060	10 x 60 Ø10	82,597	TX40	-	50	300
TNUXA10080	10 x 80 Ø10	101,540	TX40	10	50	300
TNUXA10100	10 x 100 Ø10	114,730	TX40	30	50	300
TNUXA10120	10 x 120 Ø10	132,177	TX40	50	50	300
TNUXA10140	10 x 140 Ø10	164,220	TX40	70	50	300
TNUXA10160	10 x 160 Ø10	175,280	TX40	90	50	200
TNUXA10180	10 x 180 Ø10	239,477	TX40	110	50	150
TNUXA10200	10 x 200 Ø10	290,320	TX40	130	50	150
TNUXA10230	10 x 230 Ø10	338,530	TX40	160	50	100

T-NUX A

Cabeza avellanada. Cincado. Homologado ETE



02 Info. Técnica P. 377



Disponible en varios recubrimientos. Consulte precio y plazo de entrega.

• Medidas sin homologar
• Medida sin homologar para fuego

Blíster

CÓDIGO	MEDIDA	€/BOLSA	PCS. BOLSAS
BZTNXA08080	8 x 80 Ø8	3,427	2 15
BZTNXA08100	8 x 100 Ø8	3,427	2 15
BZTNXA08120	8 x 120 Ø8	3,427	2 15
BZTNXA10080	10 x 80 Ø10	3,427	2 15
BZTNXA10100	10 x 100 Ø10	3,427	2 15
BZTNXA10120	10 x 120 Ø10	3,427	2 15

Caja con Ventana

CÓDIGO	MEDIDA	€/CAJA	PCS. CAJAS
VTNUXA08080	8 x 80 Ø8	6,048	8 8
VTNUXA08100	8 x 100 Ø8	7,559	8 8
VTNUXA10080	10 x 80 Ø10	10,063	8 8
VTNUXA10100	10 x 100 Ø10	11,373	8 8

Bolsa Autoservicio

CÓDIGO	MEDIDA	€/BOLSA	PCS. BOLSAS
LSTNXA08080	8 x 80 Ø8	7,074	10 8
LSTNXA08100	8 x 100 Ø8	8,422	10 8
LSTNXA08120	8 x 120 Ø8	9,273	8 8
LSTNXA10080	10 x 80 Ø10	9,968	8 8
LSTNXA10100	10 x 100 Ø10	7,602	6 6



CÓDIGO	MEDIDA	€/100		ESPESOR MÁX. A FIJAR		
• TNXA408080	8 x 80 Ø8	264,814	TX30	10	50	600
• TNXA408100	8 x 100 Ø8	319,321	TX30	30	50	600
• TNXA408120	8 x 120 Ø8	394,477	TX30	50	50	300
TNXA410080	10 x 80 Ø10	337,061	TX40	10	50	300
TNXA410100	10 x 100 Ø10	402,435	TX40	30	50	300
TNXA410120	10 x 120 Ø10	468,663	TX40	50	50	300
TNXA410140	10 x 140 Ø10	555,749	TX40	70	50	300

T-NUX A A4

Inoxidable A4. Cabeza avellanada. Homologado ETE



02 Info. Técnica P. 378



• Medida sin homologar para fuego



CÓDIGO	MEDIDA	€/100		ESPESOR MÁX. A FIJAR		
• TNUXE08060	8 x 60 Ø8	64,090	TX30	H10	-	600
• TNUXE08080	8 x 80 Ø8	73,037	TX30	H10	10	600
• TNUXE08100	8 x 100 Ø8	92,263	TX30	H10	30	300
• TNUXE08120	8 x 120 Ø8	108,050	TX30	H10	50	300
• TNUXE10060	10 x 60 Ø10	94,403	TX40	H13	-	300
TNUXE10080	10 x 80 Ø10	111,317	TX40	H13	10	300
TNUXE10100	10 x 100 Ø10	129,080	TX40	H13	30	300
TNUXE10120	10 x 120 Ø10	172,220	TX40	H13	50	300
TNUXE10140	10 x 140 Ø10	219,787	TX40	H13	70	200
TNUXE10160	10 x 160 Ø10	220,300	TX40	H13	90	150
TNUXE10180	10 x 180 Ø10	265,590	TX40	H13	110	150
TNUXE10200	10 x 200 Ø10	351,127	TX40	H13	130	150
TNUXE10230	10 x 230 Ø10	427,877	TX40	H13	160	100

T-NUX E

Cabeza hexagonal. Cincado. Homologado ETE



02 Info. Técnica P. 378



• Medidas sin homologar
• Medida sin homologar para fuego

Disponible en varios recubrimientos. Consulte precio y plazo de entrega.

Blíster

CÓDIGO	MEDIDA	€/BOLSA	PCS. BOLSAS
BZTNXE08080	8 x 80 Ø8	3,427	2 15
BZTNXE08100	8 x 100 Ø8	3,427	2 15
BZTNXE08120	8 x 120 Ø8	3,427	2 15
BZTNXE10080	10 x 80 Ø10	3,427	2 15
BZTNXE10100	10 x 100 Ø10	3,427	2 15
BZTNXE10120	10 x 120 Ø10	3,427	2 15

Caja con Ventana

CÓDIGO	MEDIDA	€/CAJA	PCS. CAJAS
VTNUXE08080	8 x 80 Ø8	7,242	8 8
VTNUXE08100	8 x 100 Ø8	9,146	8 8
VTNUXE10080	10 x 80 Ø10	11,035	8 8
VTNUXE10100	10 x 100 Ø10	12,792	8 8

Bolsa Autoservicio

CÓDIGO	MEDIDA	€/BOLSA	PCS. BOLSAS
LSTNXE08080	8 x 80 Ø8	8,064	10 8
LSTNXE08100	8 x 100 Ø8	10,190	10 8
LSTNXE08120	8 x 120 Ø8	10,696	8 8
LSTNXE10080	10 x 80 Ø10	7,377	6 6
LSTNXE10100	10 x 100 Ø10	8,556	6 6

T-NUX

Taco de nylon universal de alto rendimiento

T-NUX E A4

Inoxidable A4. Cabeza hexagonal. Homologado ETE



02 Info. Técnica
P. 378



CÓDIGO	MEDIDA	€/100			ESPESOR MÁX. A FIJAR		
• TNXE408080	8 x 80 Ø8	371,738	TX30	H10	10	50	600
• TNXE408100	8 x 100 Ø8	440,603	TX30	H10	30	50	300
TNXE410080	10 x 80 Ø10	493,074	TX40	H13	10	50	300
TNXE410100	10 x 100 Ø10	514,943	TX40	H13	30	50	300
TNXE410120	10 x 120 Ø10	618,968	TX40	H13	50	50	300
TNXE410140	10 x 140 Ø10	722,024	TX40	H13	70	50	200

• Medida sin homologar para fuego

T-NUX T

Cabeza Truss inviolable. Cincado. Homologado ETE



02 Info. Técnica
P. 378



Disponible en varios recubrimientos. Consulte precio y plazo de entrega.

CÓDIGO	MEDIDA	€/100		ESPESOR MÁX. A FIJAR		
TNUXT10080	10 x 80 Ø10	114,740	TX40	10	50	300
TNUXT10100	10 x 100 Ø10	129,647	TX40	30	50	300
TNUXT10120	10 x 120 Ø10	152,260	TX40	50	50	200
TNUXT10140	10 x 140 Ø10	189,173	TX40	70	50	200
TNUXT10160	10 x 160 Ø10	201,910	TX40	90	50	200

*Incluye estrella inviolable

T-FUX E

Taco cabeza cilíndrica. Tornillo cabeza hexagonal. Cincado. Homologado ETE



02 Info. Técnica
P. 378



Disponible en varios recubrimientos. Consulte precio y plazo de entrega.



CÓDIGO	MEDIDA	€/100		ESPESOR MÁX. A FIJAR		
TFUXE10080	10 x 80 Ø10	124,287	TX40	10	50	300
TFUXE10100	10 x 100 Ø10	144,123	TX40	30	50	200
TFUXE10120	10 x 120 Ø10	188,147	TX40	50	50	200

T-NUX

Taco de nylon



CÓDIGO	MEDIDA	€/100		
TNUX08060	8 x 60	25,637	50	800
TNUX08080	8 x 80	27,647	50	600
TNUX08100	8 x 100	31,870	50	600
TNUX08120	8 x 120	35,150	50	600
TNUX10060	10 x 60	33,043	50	600
TNUX10080	10 x 80	33,507	50	600
TNUX10100	10 x 100	40,777	50	600
TNUX10120	10 x 120	48,037	50	600
TNUX10140	10 x 140	62,563	50	300



Taco clavable poliamida 6.6

TCA

MULTIMATERIAL



CÓDIGO	MEDIDA	€/100		ESPESOR MÁX. A FIJAR		
TC6A08080	8 x 80 Ø8	52,823	TX30	15	100	600
TC6A08100	8 x 100 Ø8	61,403	TX30	35	100	400
TC6A08120	8 x 120 Ø8	72,570	TX30	55	100	400
TC6A10100	10 x 100 Ø10	87,153	TX40	25	100	300
TC6A10120	10 x 120 Ø10	92,533	TX40	40	100	300
TC6A10140	10 x 140 Ø10	106,850	TX40	60	100	300
TC6A10160	10 x 160 Ø10	125,383	TX40	85	100	200
TC6A10200	10 x 200 Ø10	208,260	TX40	125	100	-

TC-6A

Taco de 6 alas con tornillo avellanado



02 Info. Técnica
P. 378

MULTIMATERIAL



CÓDIGO	MEDIDA	€/100		ESPESOR MÁX. A FIJAR		
TC6E08080	8 x 80 Ø8	60,477	10	15	100	600
TC6E08100	8 x 100 Ø8	70,507	10	35	100	400
TC6E08120	8 x 120 Ø8	83,813	10	55	100	300
TC6E10100	10 x 100 Ø10	101,857	13	25	100	300
TC6E10120	10 x 120 Ø10	105,613	13	40	100	300
TC6E10140	10 x 140 Ø10	124,653	13	60	100	200
TC6E10160	10 x 160 Ø10	147,283	13	85	100	200
TC6E10200	10 x 200 Ø10	248,573	13	125	100	-

TC-6E

Taco de 6 alas con tornillo hexagonal



02 Info. Técnica
P. 379

MULTIMATERIAL



CÓDIGO	MEDIDA	€/100		ESPESOR MÁX. A FIJAR		
TC2A06060	6 X 60 Ø6	26,780	2	30	100	1.200
TC2A08060	8 X 60 Ø8	35,360	3	20	100	600
TC2A08080	8 x 80 Ø8	46,650	3	40	100	600
TC2A08100	8 x 100 Ø8	59,347	3	60	100	400
TC2A08120	8 x 120 Ø8	72,227	3	80	100	400
TC2A10065	10 x 65 Ø10	67,863	4	20	100	400
TC2A10080	10 x 80 Ø10	72,183	4	35	100	400
TC2A10100	10 x 100 Ø10	77,363	4	55	100	300
TC2A10115	10 x 115 Ø10	84,600	4	70	100	300
TC2A10135	10 x 135 Ø10	95,183	4	90	100	300
TC2A10160	10 x 160 Ø10	111,933	4	115	100	200

TC-2A

Taco de 2 alas con tornillo avellanado



02 Info. Técnica
P. 379

TC-SP

Taco clavable de alta expansión

TC-SP

Taco con cabeza avellanada



Info. Técnica
P. 379

MULTIMATERIAL



CÓDIGO	MEDIDA	€/100		ESPESOR MÁX. A FIJAR		
TCSP05027	5 x 27	8,593	PZ2	5	100	2.400
TCSP06032	6 x 32	10,113	PZ2	5	100	1.200
TCSP06040	6 x 40	10,480	PZ2	10	100	1.200

TC-SP EP

Bote de plástico



MULTIMATERIAL



CÓDIGO	MEDIDA	€/BOTE		ESPESOR MÁX. A FIJAR	PCS X BOTE
TCSPE05027	5 x 27	62,439	PZ2	5	750
TCSPE06032	6 x 32	49,038	PZ2	5	500
TCSPE06040	6 x 40	50,643	PZ2	10	500



TC

Taco clavable de poliamida 6,6, premontado con tornillo rosca-arpón

TC-A2

Taco con cabeza avellanada y tornillo inoxidable A2



Info. Técnica
P. 380

INOXIDABLE



CÓDIGO	MEDIDA	€/100		ESPESOR MÁX. A FIJAR		
TCA205030	5 x 30 Ø5	38,072	PZ2	5	100	2.400
TCA206040	6 x 40 Ø6	52,017	PZ2	10	100	1.200
TCA206060	6 x 60 Ø6	64,710	PZ2	30	100	1.200
TCA208060	8 x 60 Ø8	101,847	PZ3	20	100	600
TCA208080	8 x 80 Ø8	119,480	PZ3	40	100	600
TCA208100	8 x 100 Ø8	157,150	PZ3	60	100	600

TC-CC

Taco con cabeza cilíndrica



Info. Técnica
P. 380

MULTIMATERIAL



CÓDIGO	MEDIDA	€/100		ESPESOR MÁX. A FIJAR	UD. MIN. VENTA		
TCCC05025	5 x 25 Ø5	7,357	PZ2	5	400	100	2.400
TCCC05030	5 x 30 Ø5	7,690	PZ2	5	400	100	2.400
TCCC05035	5 x 35 Ø5	8,697	PZ2	10	400	100	2.400
TCCC05050	5 x 50 Ø5	9,827	PZ2	25	200	100	1.200
TCCC06035	6 x 35 Ø6	9,480	PZ2	10	400	100	1.200
TCCC06040	6 x 40 Ø6	9,570	PZ2	15	400	100	1.200
TCCC06050	6 x 50 Ø6	11,613	PZ2	25	200	100	1.200
TCCC06060	6 x 60 Ø6	13,597	PZ2	35	200	100	1.200
TCCC06070	6 x 70 Ø6	16,797	PZ2	45	200	100	1.200
TCCC06080	NEW 6 x 80 Ø6	18,293	PZ 2	55	200	100	1.200
TCCC08060	8 x 60 Ø8	20,487	PZ3	20	200	100	600
TCCC08080	8 x 80 Ø8	25,943	PZ3	40	200	100	600
TCCC08100	8 x 100 Ø8	31,720	PZ3	60	100	100	600
TCCC08120	8 x 120 Ø8	38,376	PZ3	80	100	100	400
TCCC08140	8 x 135 Ø8	48,175	PZ3	100	100	100	300

Bolsa Autoservicio

CÓDIGO	MEDIDA	€/BOLSA	PCS.	BOLSAS
LSTCCC05025	5 x 25 Ø5	3,380	30	10
LSTCCC05030	5 x 30 Ø5	3,562	30	8
LSTCCC05035	5 x 35 Ø5	3,794	30	7
LSTCCC05050	5 x 50 Ø5	4,264	30	7
LSTCCC06035	6 x 35 Ø6	4,233	30	7
LSTCCC06040	6 x 40 Ø6	4,283	30	6
LSTCCC06050	6 x 50 Ø6	4,407	25	6
LSTCCC06060	6 x 60 Ø6	5,075	25	6
LSTCCC06070	6 x 70 Ø6	5,545	25	6
LSTCCC08060	8 x 60 Ø8	5,503	20	6
LSTCCC08080	8 x 80 Ø8	6,888	20	6

Taco clavable de poliamida 6.6, premontado con tornillo rosca-arpón

MULTIMATERIAL



CÓDIGO	MEDIDA	€/100		ESPESOR MÁX. A FIJAR	UD. MIN. VENTA		
TCCA05025	5 x 25 Ø5	7,357	PZ2	5	400	100	2.400
TCCA05030	5 x 30 Ø5	7,690	PZ2	5	400	100	2.400
TCCA05035	5 x 35 Ø5	8,697	PZ2	10	400	100	2.400
TCCA05050	5 x 50 Ø5	9,827	PZ2	25	200	100	1.200
TCCA06035	6 x 35 Ø6	9,480	PZ2	10	400	100	1.200
TCCA06040	6 x 40 Ø6	9,570	PZ2	10	400	100	1.200
TCCA06050	6 x 50 Ø6	11,613	PZ2	20	200	100	1.200
TCCA06060	6 x 60 Ø6	13,597	PZ2	30	200	100	1.200
TCCA06070	6 x 70 Ø6	16,797	PZ2	40	200	100	1.200
TCCA06080	6 x 80 Ø6	18,293	PZ2	50	200	100	1.200
TCCA08060	8 x 60 Ø8	20,487	PZ3	20	200	100	600
TCCA08080	8 x 80 Ø8	25,943	PZ3	40	200	100	600
TCCA08100	8 x 100 Ø8	31,720	PZ3	60	100	100	600
TCCA08120	8 x 120 Ø8	38,376	PZ3	80	100	100	400
TCCA08140	8 x 135 Ø8	48,175	PZ3	100	100	100	300

TC-CA

Taco con cabeza avellanada



Info Técnica
P. 379



TAMBIÉN DISPONIBLE EN
easykits

Blíster

Caja con Ventana

Bolsa Autoservicio

CÓDIGO	MEDIDA	€/BOLSA	PCS. BOLSAS	CÓDIGO	MEDIDA	€/CAJA	PCS. CAJAS	CÓDIGO	MEDIDA	€/BOLSA	PCS. BOLSAS
BZTCCA05030	5 x 30 Ø5	2,565	4 20	VTCCA05025	5 x 25 Ø5	3,165	30 8	LSTCCA05025	5 x 25 Ø5	3,380	30 10
BZTCCA05050	5 x 50 Ø5	2,565	4 20	VTCCA05030	5 x 30 Ø5	3,322	30 8	LSTCCA05030	5 x 30 Ø5	3,562	30 8
BZTCCA06040	6 x 40 Ø6	2,565	4 20	VTCCA05035	5 x 35 Ø5	3,662	30 8	LSTCCA05035	5 x 35 Ø5	3,794	30 7
BZTCCA06050	6 x 50 Ø6	2,565	4 20	VTCCA05050	5 x 50 Ø5	4,044	30 8	LSTCCA05050	5 x 50 Ø5	4,264	30 7
BZTCCA06060	6 x 60 Ø6	2,565	4 20	VTCCA06035	6 x 35 Ø6	3,901	30 8	LSTCCA06035	6 x 35 Ø6	4,233	30 7
BZTCCA06070	6 x 70 Ø6	2,565	4 20	VTCCA06040	6 x 40 Ø6	4,002	30 8	LSTCCA06040	6 x 40 Ø6	4,283	30 6
BZTCCA08060	8 x 60 Ø8	2,565	4 20	VTCCA06050	6 x 50 Ø6	4,395	30 8	LSTCCA06050	6 x 50 Ø6	4,407	25 6
BZTCCA08080	8 x 80 Ø8	2,565	4 20	VTCCA06060	6 x 60 Ø6	4,534	25 8	LSTCCA06060	6 x 60 Ø6	5,075	25 6
BZTCCA08100	8 x 100 Ø8	2,565	2 20	VTCCA06070	6 x 70 Ø6	5,599	25 8	LSTCCA06070	6 x 70 Ø6	5,545	25 6
BZTCCA08120	8 x 120 Ø8	2,565	2 20	VTCCA08060	8 x 60 Ø8	5,448	20 8	LSTCCA08060	8 x 60 Ø8	5,503	20 6
				VTCCA08080	8 x 80 Ø8	6,953	20 8	LSTCCA08080	8 x 80 Ø8	6,888	20 6

MULTIMATERIAL



CÓDIGO	MEDIDA	€/BOTE		ESPESOR MÁX. A FIJAR	UD. MIN. VENTA	PCS X BOTE
TCCAEP5030	5 x 30 Ø5	53,842	PZ2	5	2 botes	750
TCCAEP6040	6 x 40 Ø6	45,068	PZ2	10	2 botes	500

TC-CA EP

Bote de plástico



TN4S

Los tacos de nylon anudables TN4S de INDEX, ofrecen unas máximas prestaciones gracias a su expansión en 4 direcciones. Destacan por su versatilidad en la instalación, siendo aptos para su aplicación tanto en materiales macizos (hormigón, ladrillo macizo), como en materiales huecos (ladrillo hueco, bloques de hormigón hueco, placa yeso). Pueden llegar a soportar cargas de más de 600 kg por punto de apoyo. Están fabricados con Nylon® de alta calidad (poliamida 6).



CUALIDADES Y VENTAJAS



MÁXIMAS PRESTACIONES

Expande en 4 direcciones, lo que garantiza una perfecta adherencia sobre el material base. En los materiales huecos, al introducir el tornillo/tirafondo, el taco se anuda retrayéndose y presionando sobre el material base y permitiendo un correcto agarre.



MULTIMATERIAL

Recomendado tanto para materiales base macizos (hormigón, piedra, ladrillo macizo, ladrillo de adobe, hormigón celular), como huecos (ladrillo hueco, bloque hueco, placa de yeso laminado, placas alveolares).



VERSATILIDAD

Recomendable para utilizar con una amplia gama de tornillos (tornillos con rosca aglomerado, tornillos avellanados, tornillos barraqueros...), así como otro tipo de productos (alcayatas o hembrillas).



FACILIDAD DE USO

El collarín evita que el taco se cuele en el interior del material base durante la instalación. El taco dispone de varios anti-giros laterales que ayudan a que el taco no gire al introducir el tornillo/tirafondo.

APLICACIONES



- Verjas
- Barandillas
- Soportes
- Estanterías
- Rótulos
- Sanitarios y/o instalaciones de baños
- Cuadros
- Elementos ligeros
- Iluminación
- Rodapiés
- Buzones
- Muebles de TV
- Canaletas eléctricas
- Muebles

TN4S

Taco de nylon anudable de 4 segmentos para todo tipo de materiales

TN4S

Taco de nylon



Info. Técnica
p. 332

MULTIMATERIAL



CÓDIGO	MEDIDA	€/100	MEDIDA TORNILLO (Ø L)	UD. MIN. VENTA		
TN4S05	5 x 25 Ø5	3,973	Ø2,5 - Ø4 L: 30 mm.	400	100	4.200
TN4S06	6 x 30 Ø6	4,153	Ø3,5 - Ø4,5 L: 40 mm.	400	100	3.200
TN4S08	8 x 40 Ø8	6,513	Ø4,5 - Ø6 L: 50 mm.	400	100	1.600
TN4S10	10 x 50 Ø10	11,693	Ø6 - Ø8 L: 60 mm.	200	50	800
TN4S12	12 x 60 Ø12	23,660	Ø8 - Ø10 L: 70 mm.	50	25	400
TN4S14	14 x 70 Ø14	30,747	Ø10 - Ø12 L: 80 mm.	40	20	320



Blíster

CÓDIGO	MEDIDA	€/BOLSA	PCS.	BOLSAS
BZTN4S05	5 x 25 Ø5	2,565	25	15
BZTN4S06	6 x 30 Ø6	2,565	25	15
BZTN4S08	8 x 40 Ø8	2,565	15	10
BZTN4S10	10 x 50 Ø10	2,565	10	10
BZTN4S12	12 x 60 Ø12	2,565	6	10



TN4S EP

Bote de plástico



MULTIMATERIAL



CÓDIGO	MEDIDA	€/BOTE	UD. MIN. VENTA	PCS X BOTE
TN4S06EP	6 x 30 Ø6	38,217	2 botes	1.000
TN4S08EP	8 x 40 Ø8	30,253	2 botes	500
TN4S10EP	10 x 50 Ø10	32,275	2 botes	300



Taco de nylon anudable de 4 segmentos para todo tipo de materiales

TN4S

Kits TN4S + Fijación



Blíster



CÓDIGO	MEDIDA	€/BOLSA	PCS.	BOLSAS
BZALHATS05	5 x 25 Ø5 + 19x70 / 4,4x50	2,565	6	20
BZALHATS06	6x30 Ø6 + 20x80 / 5x53	2,565	6	15
BZALHATS08	8x40 Ø8 + 21x100 / 5,6x60	2,565	4	20

BZ TN4S + AL-HA



Blíster



CÓDIGO	MEDIDA	€/BOLSA	PCS.	BOLSAS
BZALHCTS05	5x25 Ø5 + 19x70 / 4,4x50	2,565	6	20
BZALHCTS06	6x30 Ø6 + 20x80 / 5x53	2,565	6	15
BZALHCTS08	8x40 Ø8 + 21x100 / 5,6x60	2,565	4	20

BZ TN4S + AL-HC



Blíster



CÓDIGO	MEDIDA	€/BOLSA	PCS.	BOLSAS
BZALROTS05	5x25 Ø5 + 18x50 / 4,1x37	2,565	6	20
BZALROTS06	6x30 Ø6 + 19x60 / 4,4x46	2,565	6	20
BZALROTS08	8x40 Ø8 + 20x80 / 5x63	2,565	4	20

BZ TN4S + AL-RO



Caja con Ventana

CÓDIGO	MEDIDA	€/CAJA	PCS.	CAJAS
VTBTS08	8 x 40 Ø8 & 6 x 60	6,957	25	8
VTBTS10	10 x 50 Ø10 & 7 x 70	7,211	15	8
VTBTS12	12 x 60 Ø12 & 7 x 70	6,937	10	8



Blíster



CÓDIGO	MEDIDA	€/BOLSA	PCS.	BOLSAS
BZTBT10	10x50 Ø10 + 7x70	2,565	4	20

BZ TN4S + DIN-571



Caja con Ventana

CÓDIGO	MEDIDA	€/CAJA	PCS.	CAJAS
VTPPOTS05	5 x 25 Ø5 & 4 x 30	4,932	40	8
VTPPOTS06	6 x 30 Ø6 & 4,5 x 40	5,144	32	8
VTPPOTS08	8 x 40 Ø8 & 5 x 60	5,436	20	8



Blíster



CÓDIGO	MEDIDA	€/BOLSA	PCS.	BOLSAS
BZTPPOTS05	5x25 Ø5 + 4x30	2,565	6	20
BZTPPOTS06	6x30 Ø6 + 4,5x40	2,565	6	20
BZTPPOTS08	8x40 Ø8 + 5x60	2,565	6	15

BZ TN4S + TP-PO



MULTIMATERIAL



CÓDIGO	MEDIDA	€/100	MEDIDA TORNILLO (Ø L)		
TN4S06L	6 x 45 Ø6	7,011	Ø3,5 - Ø4,5 L: 60 mm.	100	1.600
TN4S08L	8 x 60 Ø8	11,172	Ø4,5 - Ø6 L: 70 mm.	50	800
TN4S10L	10 x 80 Ø10	19,674	Ø6 - Ø8 L: 90 mm.	25	400

TN4S-L

Taco largo



02
P. 382
Info.
Técnica

MEDU

Taco universal con collarín y forma de nudo



02 Info Técnica P. 382

CÓDIGO	MEDIDA	€/100	VÁLIDO PARA	UD. MIN. VENTA		
MEDUB06	6 x 35 Ø6	3,500	TPPO 3,5-4	600	150	2.400
MEDUB07	8 x 42 Ø8	7,130	TPPO 4-4,5	400	100	1.600
MEDUB08	8 x 50 Ø8	6,013	TPPO 4-4,5	320	80	1.200
MEDUB10	10 x 60 Ø10	9,003	TPPO 5-6; TB 5,6,7	200	50	800

Blíster

CÓDIGO	MEDIDA	€/BOLSA	PCS.	BOLSAS
BZMEDUB06	6 x 35 Ø6	2,565	10	20
BZMEDUB08	8 x 50 Ø8	2,565	10	20
BZMEDUB10	10 x 60 Ø10	2,565	6	20

TACON

Taco de nylon

Kits TACON + Fijación

BZ TACON + AL-HA



CÓDIGO	MEDIDA	€/BOLSA	PCS.	BOLSAS
BZALHAT04	4x20 Ø4 + 16x30 / 3,1x25	2,029	6	20
BZALHAT05	5x25 Ø5 + 19x70 / 4,4x50	2,029	6	20
BZALHAT06	6x30 Ø6 + 20x80 / 5x55	2,029	6	15
BZALHAT08	8x40 Ø8 + 21x100 / 5,6x60	2,029	4	15

BZ TACON + AL-HC



CÓDIGO	MEDIDA	€/BOLSA	PCS.	BOLSAS
BZALHCT04	4x20 Ø4 + 16x30 / 3,1x25	2,029	6	20
BZALHCT05	5x25 Ø5 + 19x70 / 4,4x50	2,029	6	20
BZALHCT06	6x30 Ø6 + 20x80 / 5x55	2,029	6	15
BZALHCT08	8x40 Ø8 + 21x100 / 5,6x60	2,029	4	15

BZ TACON + AL-RO



CÓDIGO	MEDIDA	€/BOLSA	PCS.	BOLSAS
BZALROT04	4x20 Ø4 + 16x30 / 3,1x20	2,029	6	20
BZALROT05	5x25 Ø5 + 17x40 / 3,5x29	2,029	6	20
BZALROT06	6x30 Ø6 + 19x60 / 4,4x46	2,029	6	20
BZALROT08	8x40 Ø8 + 20x80 / 5x63	2,029	4	15

BZ TACON + TP-PO



CÓDIGO	MEDIDA	€/BOLSA	PCS.	BOLSAS
BZTPPOT04	4x20 Ø4 + 2,5x25	2,029	6	20
BZTPPOT05	6x30 Ø5 + 3,5x20	2,029	6	20
BZTPPOT06	6x30 Ø6 + 4,5x40	2,029	6	20
BZTPPOT08	8x40 Ø8 + 6x50	2,029	4	15

KITS DISPONIBLES BLISTER





Taco de nylon

TACON

MULTIMATERIAL



CÓDIGO	MEDIDA	€/100	MEDIDA TORNILLO (mm)	UD. MIN. VENTA		
TACON04	4 x 20 Ø4	2,543	TPPO 2,5-3	400	100	8.000
TACON05	5 x 25 Ø5	1,837	TPPO 2,5-4	400	100	8.000
TACON06	6 x 30 Ø6	1,883	TPPO 3,5-4	400	100	9.000
TACON07	7 x 30 Ø7	3,933	TPPO 4-4,5	400	100	5.000
TACON08	8 x 40 Ø8	3,710	TPPO 4,5, TB 5-6	400	100	5.000
TACON10	10 x 50 Ø10	6,253	TB 6-8	200	50	2.500
TACON12	12 x 60 Ø12	11,460	TB 8-10	100	25	1.250
TACON14	14 x 70 Ø14	18,527	TB 10-12	80	20	1.000
TACON16	16 x 80 Ø16	105,017	TB 12-14	40	10	500

TACON

Taco



02
p. 382
Info
Técnica

Blíster

CÓDIGO	MEDIDA	€/BOLSA	PCS. 	BOLSAS
BZTACON04	4 x 20 Ø4	2,029	25	15
BZTACON05	5 x 25 Ø5	2,029	25	15
BZTACON06	6 x 30 Ø6	2,029	25	15
BZTACON08	8 x 40 Ø8	2,029	15	10
BZTACON10	10 x 50 Ø10	2,029	10	10
BZTACON12	12 x 60 Ø12	2,029	5	10

MULTIMATERIAL



CÓDIGO	MEDIDA	€/100	MEDIDA TORNILLO (mm)	UD. MIN. VENTA		
TACOL05	5 x 25 Ø5	2,613	TPPO 2,5-4	400	100	8.000
TACOL06	6 x 30 Ø6	2,233	TPPO 3,5-4	400	100	9.000
TACOL08	8 x 40 Ø8	4,387	TPPO 4,5, TB 5-6	400	100	5.000
TACOL10	10 x 50 Ø10	7,880	TB 6-8	200	50	2.500
TACOL12	12 x 60 Ø12	17,117	TB 8-10	100	25	1.250

TACOL

Taco con collarín



02
p. 382
Info
Técnica

MULTIMATERIAL



CÓDIGO	MEDIDA	€/100	MEDIDA TORNILLO		
TACOLA06	6 x 30 Ø6	2,590	TPPO 3,5-4	100	2.400

TACOL-A

Taco de nylon con collarín ancho



02
p. 383
Info
Técnica

IPA

Taco de nylon para ladrillos huecos y materiales macizos

IPA-GR

Gancho recto



02 Info Técnica P. 383

MULTIMATERIAL



CÓDIGO	MEDIDA	€/100	Ø ARANDELA	UD. MIN. VENTA		
IPAGR09	M4 x 40 Ø9	41,260	20	100	50	800
IPAGR12	M5 x 45 Ø12	58,197	25	50	25	400

IPA-GN

Gancho normal



02 Info Técnica P. 383

MULTIMATERIAL



CÓDIGO	MEDIDA	€/100	Ø ARANDELA	UD. MIN. VENTA		
IPAGN09	M4 x 40 Ø9	48,233	20	80	40	640
IPAGN12	M5 x 45 Ø12	66,083	25	40	20	320

IPA-AR

Argolla



02 Info Técnica P. 383

MULTIMATERIAL



CÓDIGO	MEDIDA	€/100	Ø ARANDELA	UD. MIN. VENTA		
IPAAR09	M4 x 40 Ø9	48,133	20	80	40	640
IPAAR12	M5 x 45 Ø12	65,827	25	40	20	320

IPA-TO

Tornillo



02 Info Técnica P. 383

MULTIMATERIAL



CÓDIGO	MEDIDA	€/100	Ø ARANDELA	UD. MIN. VENTA		
IPATO09	M4 x 40 Ø9	37,793	20	140	70	1.120
IPATO12	M5 x 45 Ø12	51,743	25	70	35	560

TA-PL

Taco de plástico (polipropileno)



02 Info Técnica P. 383

MULTIMATERIAL



CÓDIGO	MEDIDA	€/100	UD. MIN. VENTA		
TACOP05	5 x 21 Ø5	1,943	1.000	25	1.000
TACOP06	6 x 22 Ø6	2,183	1.000	25	1.000
TACOP07	7 x 23 Ø7	2,407	1.000	25	1.000
TACOP08	8 x 27 Ø8	2,607	1.000	25	1.000
TACOP09	9 x 30 Ø9	3,670	1.000	25	1.000
TACOP10	10 x 35 Ø10	4,697	1.000	25	1.000
TACOP11	10 x 43 Ø10	7,237	500	25	500
TACOP12	12 x 45 Ø12	7,247	500	25	500
TACOP14	14 x 48 Ø14	9,863	500	25	500



FIJACIONES Y ACCESORIOS PARA SISTEMAS DE AISLAMIENTO TÉRMICO (SATE)



AIS

Taco de fijación de paneles aislantes

AIS-C

Taco con clavo de poliamida



MULTIMATERIAL



CÓDIGO	MEDIDA	€/100	ESPESOR MÁX. A FIJAR	Ø ARANDELA	
AISC10070	10 x 70 Ø10	23,954	10-20	52	200
AISC10090	10 x 90 Ø10	25,855	30-40	52	200
AISC10100	10 x 100 Ø10	26,817	40-50	52	200
•AISC10110	10 x 110 Ø10	30,365	50-60	52	100
AISC10120	10 x 120 Ø10	30,438	60-70	52	200
•AISC10130	10 x 130 Ø10	33,666	70-80	52	100
AISC10140	10 x 140 Ø10	34,171	80-90	52	200
AISC10160	10 x 160 Ø10	36,961	100-110	52	200
AISC10180	10 x 180 Ø10	41,583	120-130	52	200
AISC10200	10 x 200 Ø10	54,948	140-150	52	200
AISC10220	10 x 220 Ø10	59,280	150-170	52	200
AISC10260	10 x 260 Ø10	66,595	200-210	52	100

• Medidas sin homologar
• Hasta fin de existencias

NEW AIS-S

Taco con clavo metálico y tapón de poliamida



MULTIMATERIAL



CÓDIGO	MEDIDA	€/100	ESPESOR MÁX. A FIJAR		
AISS10070	10 x 70 Ø10	52,698	10-20	200	-
AISS10090	10 x 90 Ø10	59,467	30-40	200	-
AISS10100	10 x 100 Ø10	64,361	40-50	200	-
AISS10120	10 x 120 Ø10	73,051	60-70	200	-
AISS10140	10 x 140 Ø10	82,011	80-90	200	-
AISS10160	10 x 160 Ø10	88,707	100-110	200	-
AISS10180	10 x 180 Ø10	95,641	120-130	200	-
AISS10200	10 x 200 Ø10	109,896	140-150	200	-
AISS10220	10 x 220 Ø10	118,560	150-170	200	-
AISS10260	10 x 260 Ø10	133,190	200-210	100	-

AIS

Taco



MULTIMATERIAL



CÓDIGO	MEDIDA	€/100	ESPESOR MÁX. A FIJAR	Ø ARANDELA		
AIS08080	8 x 80 Ø8	21,190	20 - 50	35	100	200
AIS08100	8 x 100 Ø8	24,370	50 - 70	35	100	-
AIS08120	8 x 120 Ø8	27,043	70 - 90	35	100	-
AIS08140	8 x 140 Ø8	27,690	90 - 110	35	100	-

NEW AIS-R

Rosetón



MULTIMATERIAL



CÓDIGO	MEDIDA	€/100		
AISR140	Ø140	41,800	200	-



Taco de fijación de paneles aislantes

AIS

MULTIMATERIAL



CÓDIGO	MEDIDA	€/100		
AISW060	Ø60	21,200	500	-

AIS-W NEW

Rosetón para uso con tornillo



02 Info. Técnica
P. 381

MULTIMATERIAL



CÓDIGO	MEDIDA	€/100	ESPESOR MÁX. A FIJAR		
AISM08090	8 x 90 Ø8	33,600	50	250	-
AISM08110	8 x 110 Ø8	39,500	70	250	-
AISM08120	8 x 120 Ø8	40,800	80	250	-
AISM08140	8 x 140 Ø8	45,800	100	250	-
AISM08170	8 x 170 Ø8	54,900	130	250	-
AISM08200	8 x 200 Ø8	70,900	160	250	-
AISM08250	8 x 250 Ø8	83,200	210	250	-
AISM08300	8 x 300 Ø8	136,400	260	250	-

AIS-M NEW

Taco metálico



02 Info. Técnica
P. 381

MULTIMATERIAL



CÓDIGO	MEDIDA	€/100		
AISAM085	Ø85	102,700	250	-

AIS-AM NEW

Arandela para taco metálico



02 Info. Técnica
P. 381

Anclaje espiral

TE NEW

MULTIMATERIAL



CÓDIGO	MEDIDA	€/100		
TE25050	25 x 50	80,700	50	600
TE25090	25 x 90	137,200	25	300



02 Info. Técnica
P. 381



FIJACIONES PARA MATERIALES HUECOS



BA-NO

Basculantes por gravedad para la fijación de elementos ligeros en falsos techos

BA-ES

Espiga

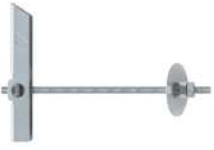

02 Info Técnica P. 334

PATENTADO

TAMBIÉN DISPONIBLE EN
easykits



CÓDIGO	MEDIDA	€/100	UD. MIN. VENTA		
BAESM04	M4 Ø14	61,907	100	50	300
BAESM05	M5 Ø14	68,050	100	50	300
BAESM06	M6 Ø16	88,513	100	50	200
BAESM08	M8 Ø20	145,577	50	50	200



Blíster



Caja con Ventana



Bolsa Autoservicio

CÓDIGO	MEDIDA	€/BOLSA	PCS. BOLSA	CÓDIGO	MEDIDA	€/CAJA	PCS. CAJAS	CÓDIGO	MEDIDA	€/BOLSA	PCS. BOLSA
BZBAESM04	M4 Ø14	3,427	2 12	VBAESM04	M4 Ø14	5,559	6 8	LSBAESM04	M4 Ø14	5,506	6 6
BZBAESM05	M5 Ø14	3,427	2 12	VBAESM05	M5 Ø14	5,722	6 8	LSBAESM05	M5 Ø14	5,668	6 6
BZBAESM06	M6 Ø16	3,427	2 10	VBAESM06	M6 Ø16	4,968	4 8	LSBAESM06	M6 Ø16	4,921	4 6

BA-GA

Gancho



02 Info Técnica P. 334

PATENTADO

TAMBIÉN DISPONIBLE EN
easykits



CÓDIGO	MEDIDA	€/100	UD. MIN. VENTA		
BAGAM04	M4 Ø14	64,387	100	50	300
BAGAM05	M5 Ø14	72,307	100	50	300
BAGAM06	M6 Ø16	90,360	100	50	200
BAGAM08	M8 Ø20	151,143	50	50	150



Blíster



Caja con Ventana



Bolsa Autoservicio

CÓDIGO	MEDIDA	€/BOLSA	PCS. BOLSA	CÓDIGO	MEDIDA	€/CAJA	PCS. CAJAS	CÓDIGO	MEDIDA	€/BOLSA	PCS. BOLSA
BZBAGAM04	M4 Ø14	3,427	2 12	VBAGAM04	M4 Ø14	5,597	6 8	LSBAGAM04	M4 Ø14	5,544	6 6
BZBAGAM05	M5 Ø14	3,427	2 12	VBAGAM05	M5 Ø14	6,028	6 8	LSBAGAM05	M5 Ø14	5,971	6 6
BZBAGAM06	M6 Ø16	3,427	2 10	VBAGAM06	M6 Ø16	5,048	4 8	LSBAGAM06	M6 Ø16	5,000	4 6

CA-BA

Cabeza de basculante



02 Info Técnica P. 334

PATENTADO

TAMBIÉN DISPONIBLE EN
easykits



CÓDIGO	MEDIDA	€/100		
CABA004	M4 Ø14	31,917	100	1.200
CABA005	M5 Ø14	34,940	100	1.200
CABA006	M6 Ø16	40,743	100	600
CABA008	M8 Ø20	70,840	100	400



Caja con Ventana



Bolsa Autoservicio

CÓDIGO	MEDIDA	€/CAJA	PCS. CAJAS	CÓDIGO	MEDIDA	€/BOLSA	PCS. BOLSA
VCABA004	M4 Ø14	8,508	20 8	LSCABA004	M4 Ø14	8,717	20 6
VCABA005	M5 Ø14	9,496	20 8	LSCABA005	M5 Ø14	9,400	20 6
VCABA006	M6 Ø16	8,185	15 8	LSCABA006	M6 Ø16	8,227	15 7

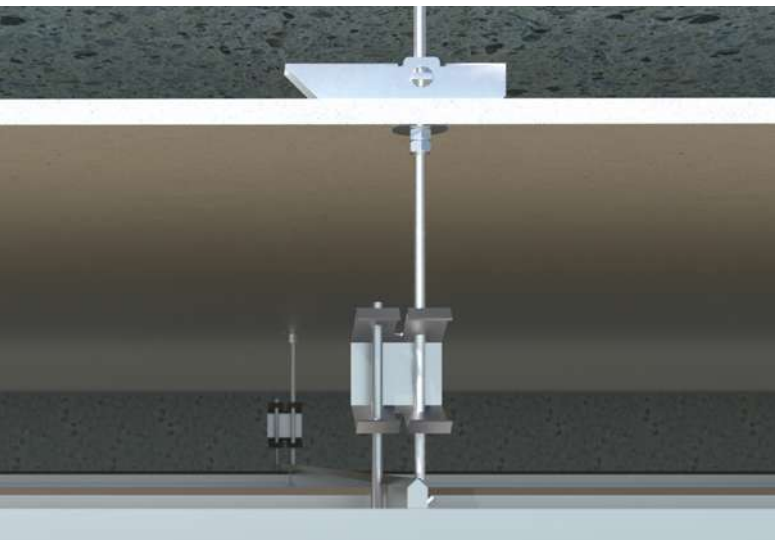



Palomilla con muelle

PA-LO

HUECOS



CÓDIGO	MEDIDA	€/100	UD. MIN. VENTA		
PAESM04	M4 Ø12	48,760	100	50	300
PAESM05	M5 Ø15	54,017	100	50	300
PAESM06	M6 Ø18	67,360	100	50	200
PAESM08	M8 Ø22	119,903	50	50	150



Blíster



Caja con Ventana



Bolsa Autoservicio

CÓDIGO	MEDIDA	€/BOLSA	PCS. BOLSAS
BZPAESM04	M4 Ø12	3,427	2 12
BZPAESM05	M5 Ø15	3,427	2 12
BZPAESM06	M6 Ø18	3,427	2 10

CÓDIGO	MEDIDA	€/CAJA	PCS. CAJAS
VPAESM04	M4 Ø12	4,425	6 8
VPAESM05	M5 Ø15	5,005	6 8
VPAESM06	M6 Ø18	4,239	4 8

CÓDIGO	MEDIDA	€/BOLSA	PCS. BOLSAS
LSPAESM04	M4 Ø12	4,346	6 6
LSPAESM05	M5 Ø15	4,957	6 6
LSPAESM06	M6 Ø18	4,160	4 6

02
P. 384

Info.
Técnica

PA-ES

Espiga



HUECOS



CÓDIGO	MEDIDA	€/100	UD. MIN. VENTA		
PAGAM04	M4 Ø12	49,717	100	50	300
PAGAM05	M5 Ø15	56,770	100	50	300
PAGAM06	M6 Ø18	79,777	100	50	200
PAGAM08	M8 Ø22	133,940	50	50	150



Blíster



Caja con Ventana



Bolsa Autoservicio

CÓDIGO	MEDIDA	€/BOLSA	PCS. BOLSAS
BZPAGAM04	M4 Ø12	3,427	2 12
BZPAGAM05	M5 Ø15	3,427	2 12
BZPAGAM06	M6 Ø18	3,427	2 10

CÓDIGO	MEDIDA	€/CAJA	PCS. CAJAS
VPAGAM04	M4 Ø12	4,267	6 8
VPAGAM05	M5 Ø15	4,964	6 8
VPAGAM06	M6 Ø18	4,465	4 8

CÓDIGO	MEDIDA	€/BOLSA	PCS. BOLSAS
LSPAGAM04	M4 Ø12	4,561	6 6
LSPAGAM05	M5 Ø15	5,187	6 6
LSPAGAM06	M6 Ø18	4,877	4 6

02
P. 384

Info.
Técnica

PA-GA

Gancho



HUECOS



CÓDIGO	MEDIDA	€/100		
CAPA004	M4 Ø12	19,060	100	2.400
CAPA005	M5 Ø15	22,077	100	1.200
CAPA006	M6 Ø18	25,997	100	600
CAPA008	M8 Ø22	58,417	100	400



Caja con Ventana



Bolsa Autoservicio

CÓDIGO	MEDIDA	€/CAJA	PCS. CAJAS
VCAPA004	M4 Ø12	6,591	24 8
VCAPA005	M5 Ø15	6,496	20 8
VCAPA006	M6 Ø18	5,964	15 8

CÓDIGO	MEDIDA	€/BOLSA	PCS. BOLSAS
LSCAPA004	M4 Ø12	6,591	24 8
LSCAPA005	M5 Ø15	6,496	20 7
LSCAPA006	M6 Ø18	5,734	15 7

CA-PA

Cabeza de palomilla



IN

Anclaje Indemoll para fijación en elementos huecos

IN-CO

Con tornillo cabeza redonda



02
P. 384
Info
Técnica



CÓDIGO	MEDIDA	€/100	MÍN. ESPESOR MATERIAL BASE		
INCO421	M4 x 30 Ø 8	28,920	1-5	100	2.400
INCO432	M4 x 41 Ø 8	29,387	3-10	100	1.200
INCO438	M4 x 47 Ø 8	31,923	9-16	100	1.200
INCO446	M4 x 53 Ø 8	34,727	15-22	100	1.200
INCO459	M4 x 67 Ø 8	39,193	31-36	100	1.200
INCO537	M5 x 46 Ø 10	40,333	5-14	100	1.200
INCO552	M5 x 59 Ø 10	43,247	6-18	100	600
INCO565	M5 x 72 Ø 10	51,343	16-33	100	600
INCO580	M5 x 89 Ø 10	57,573	33-46	100	600
INCO637	M6 x 46 Ø 12	45,987	5-13	100	1.200
INCO652	M6 x 59 Ø 12	53,417	6-17	100	600
INCO665	M6 x 72 Ø 12	59,530	14-32	100	600
INCO680	M6 x 89 Ø 12	78,173	34-46	100	600

Blíster

CÓDIGO	MEDIDA	€/BOLSA	PCS.	BOLSAS
BZINCO432	M4 x 41 Ø 8	2,565	2	20
BZINCO438	M4 x 47 Ø 8	2,565	2	20
BZINCO537	M5 x 46 Ø 10	2,565	2	20
BZINCO552	M5 x 59 Ø 10	2,565	2	15
BZINCO565	M5 x 72 Ø 10	2,565	2	15
BZINCO637	M6 x 46 Ø 12	2,565	2	15
BZINCO652	M6 x 59 Ø 12	2,565	2	15

Caja con Ventana

CÓDIGO	MEDIDA	€/CAJA	PCS.	CAJAS
VINCO432	M4 x 41 Ø 8	5,300	15	8
VINCO438	M4 x 47 Ø 8	5,730	15	8
VINCO446	M5 x 46 Ø 10	6,276	15	8
VINCO537	M5 x 59 Ø 10	7,289	15	8
VINCO552	M5 x 72 Ø 10	6,253	12	8
VINCO637	M6 x 46 Ø 12	5,509	10	8
VINCO652	M6 x 59 Ø 12	6,407	10	8

Bolsa Autoservicio

CÓDIGO	MEDIDA	€/BOLSA	PCS.	BOLSAS
LSINCO432	M4 x 41 Ø 8	9,559	30	6
LSINCO438	M4 x 47 Ø 8	10,382	30	6
LSINCO446	M5 x 46 Ø 10	11,295	30	6
LSINCO537	M5 x 59 Ø 10	10,932	25	6
LSINCO552	M5 x 72 Ø 10	8,437	18	7
LSINCO637	M6 x 46 Ø 12	9,971	20	7
LSINCO652	M6 x 59 Ø 12	8,688	15	7

IN-HE

Con tornillo cabeza hexagonal



02
P. 385
Info
Técnica



CÓDIGO	MEDIDA	€/100	CONJUNTO MATERIAL BASE Y ELEMENTO A FIJAR		
INHE837	M8 x 45 Ø 14	104,170	5-13	100	600
INHE855	M8 x 60 Ø 14	119,827	5-16	100	400
INHE865	M8 x 73 Ø 14	142,673	16-32	100	400

IN-SI

Sin tornillo



CÓDIGO	MEDIDA	€/100	MÍN. ESPESOR MATERIAL BASE		
INSI421	M4 x 21 Ø 8	22,190	1-5	100	2.400
INSI432	M4 x 32 Ø 8	24,153	3-10	100	2.400
INSI438	M4 x 38 Ø 8	26,260	9-16	100	2.400
INSI537	M5 x 37 Ø 10	31,000	5-14	100	1.200
INSI552	M5 x 52 Ø 10	36,347	6-18	100	600
INSI565	M5 x 65 Ø 10	40,310	16-33	100	600
INSI637	M6 x 37 Ø 12	37,573	5-13	100	1.200
INSI652	M6 x 52 Ø 12	45,890	6-17	100	600
INSI665	M6 x 65 Ø 12	51,410	14-32	100	600
INSI865	M8 x 65 Ø 14	89,313	17-33	100	400



Anclaje Indemoll para fijación en elementos huecos

IN

HUECOS



CÓDIGO	MEDIDA	€/100		
INPINZANI	M4, M5 & M6	1.311,566	1	20

INPIN

Pinza



HUECOS



CÓDIGO	MEDIDA	€/100		
INPISANIN	M4, M5, M6 & M8	3.212,286	1	10

INPIS

Pistola



HUECOS



CÓDIGO	COMPONENTES	MEDIDA COMPONENTES	UDS X KIT	€/KIT	KITS X
KITINPIN01	INPINZANI	44,266	1	44,266	1
	INCO432	M4 x 41 Ø 8	20		
	INCO537	M5 x 46 Ø 10	20		

KITINPIN

Kit de tabiquería seca



ANCLA

Taco de nylon para ladrillos huecos y placas de yeso



02 Info. Técnica P. 385



CÓDIGO	MEDIDA	€/100	MÍN. ESPESOR MATERIAL BASE	UD. MIN. VENTA			
ANCLA40	10 x 40 Ø10	11,443	4-12	200	100	600	
ANCLA47	10 x 47 Ø10	13,367	15-19	200	100	600	



CÓDIGO	MEDIDA	€/BOLSA	PCS.	BOLSAS
BZANCLA40	10 x 40 Ø10	2,565	4	12
BZANCLA47	10 x 47 Ø10	2,565	4	12

* Recomendado usar para tornillo TPPO 4,0

TAPLA

Taco para placas de yeso laminado

TAPLA NY

Taco de nylon



02 Info. Técnica P. 385



CÓDIGO	MEDIDA	€/100		MÍN. ESPESOR MATERIAL BASE	MEDIDA TORNILLO	UD. MIN. VENTA			
TAPLANY	15 x 33	12,200	PH3	9-16	TPPO 4,5 x 40 DIN 7981 4,2 x 38	200	100	1.600	



CÓDIGO	MEDIDA	€/BOLSA	PCS.	BOLSAS
BZTAPLANY	15 x 33	2,565	4	15

TAPLA ME

Taco de Zamak con tornillo DIN 7981 4,2 x 32



02 Info. Técnica P. 385



CÓDIGO	MEDIDA	€/100		MÍN. ESPESOR MATERIAL BASE	MEDIDA TORNILLO	UD. MIN. VENTA			
TAPLAME	13 x 32	29,890	PH2/PH3	9-16	DIN 7981 4,2 x 32	200	100	1.600	



CÓDIGO	MEDIDA	€/BOLSA	PCS.	BOLSAS
BZTAPLAME	13 x 32	3,427	4	15

TAPLA ZK

Taco de Zamak



02 Info. Técnica P. 385



CÓDIGO	MEDIDA	€/100		MÍN. ESPESOR MATERIAL BASE	MEDIDA TORNILLO	UD. MIN. VENTA			
TAPLAZK	13 x 37	31,700	PZ3	9-16	TPPO 4,5 x 50 DIN 7981 4,2 x 38	200	100	1.600	



REMACHES





RE-NO

Cabeza alomada. Aluminio



METAL



CÓDIGO	MEDIDA	€/100	Ø BROCA	ESPOSOR MÁX. A FIJAR		
RENO3206	3,2 x 6	3,830	3,3	1 - 3	500	12.000
RENO3208	3,2 x 8	4,070	3,3	3 - 5	500	12.000
RENO3210	3,2 x 10	4,490	3,3	5 - 7	500	6.000
RENO3212	3,2 x 12	4,817	3,3	7 - 9	500	6.000
RENO3214	3,2 x 14	5,230	3,3	9 - 11	500	6.000
RENO3216	3,2 x 16	5,793	3,3	11 - 13	500	6.000
RENO3218	3,2 x 18	6,697	3,3	13 - 15	500	6.000
RENO4006	4 x 6	4,243	4,1	0,5 - 2	500	6.000
RENO4008	4 x 8	4,570	4,1	2 - 4	500	6.000
RENO4010	4 x 10	5,277	4,1	4 - 6	500	6.000
RENO4012	4 x 12	5,767	4,1	6 - 8	500	6.000
RENO4014	4 x 14	6,510	4,1	8 - 10	500	6.000
RENO4016	4 x 16	6,797	4,1	10 - 12	500	6.000
RENO4018	4 x 18	7,263	4,1	12 - 14	500	3.000
RENO4020	4 x 20	7,503	4,1	14 - 16	500	6.000
RENO4025	4 x 25	9,770	4,1	16 - 18	250	3.000
RENO4030	4 x 30	11,370	4,1	23 - 16	250	3.000
RENO4035	4 x 35	14,253	4,1	26 - 30	250	3.000
RENO4806	4,8 x 6	5,567	5	0,5 - 1,5	500	6.000
RENO4808	4,8 x 8	6,560	5	1,5 - 3,5	500	6.000
RENO4810	4,8 x 10	6,893	5	3,5 - 5,5	500	3.000
RENO4812	4,8 x 12	7,263	5	5,5 - 7,5	500	3.000
RENO4814	4,8 x 14	8,313	5	7,5 - 9,5	250	3.000
RENO4816	4,8 x 16	9,020	5	9,5 - 11,5	250	3.000
RENO4818	4,8 x 18	10,293	5	11,5 - 13,5	250	3.000
RENO4820	4,8 x 20	11,083	5	13,5 - 15	250	3.000
RENO4822	4,8 x 22	12,170	5	15 - 17	200	2.400
RENO4824	4,8 x 24	12,360	5	17 - 19	200	2.400
RENO4826	4,8 x 26	13,270	5	19 - 21	200	2.400
RENO4828	4,8 x 28	14,113	5	21 - 23	200	2.400
RENO4830	4,8 x 30	14,903	5	23 - 25	200	2.400
RENO4835	4,8 x 35	16,383	5	25 - 30	150	1.800
RENO6008	6 x 8	15,333	6,1	1 - 2	250	3.000
RENO6010	6 x 10	14,440	6,1	2 - 4	250	3.000
RENO6012	6 x 12	14,823	6,1	3 - 6	250	3.000
RENO6018	6 x 18	16,887	6,1	6 - 10	200	1.200
RENO6025	6 x 25	20,807	6,1	10 - 12	200	1.200
RENO6016	6 x 16	16,240	6,1	15 - 19	250	1.500



Blíster



CÓDIGO	MEDIDA	€/BOLSA	PCS. 	BOLSAS 
BZRENO3208	3,2 x 8	2,029	15	20
BZRENO3210	3,2 x 10	2,029	15	20
BZRENO4008	4 x 8	2,029	15	20
BZRENO4010	4 x 10	2,029	15	20
BZRENO4012	4 x 12	2,029	15	20
BZRENO4016	4 x 16	2,029	15	20
BZRENO4810	4,8 x 10	2,029	15	20
BZRENO4812	4,8 x 12	2,029	15	20
BZRENO4816	4,8 x 16	2,029	8	20
BZRENO4820	4,8 x 20	2,029	8	20
BZRENO4824	4,8 x 24	2,029	8	20



Caja con Ventana

CÓDIGO	MEDIDA	€/CAJA	PCS. 	CAJAS 
VRENO3206	3,2 x 6	2,689	50	8
VRENO3208	3,2 x 8	2,671	50	8
VRENO3210	3,2 x 10	2,950	50	8
VRENO3212	3,2 x 12	3,316	50	8
VRENO3214	3,2 x 14	3,439	50	8
VRENO3218	3,2 x 18	4,354	50	8
VRENO4006	4 x 6	2,957	50	8
VRENO4008	4 x 8	2,972	50	8
VRENO4010	4 x 10	3,439	50	8
VRENO4012	4 x 12	3,751	50	8
VRENO4014	4 x 14	4,240	50	8
VRENO4016	4 x 16	4,422	50	8
VRENO4018	4 x 18	4,724	50	8
VRENO4020	4 x 20	4,880	50	8
VRENO4808	4,8 x 8	4,354	50	8
VRENO4810	4,8 x 10	4,484	50	8
VRENO4812	4,8 x 12	4,724	50	8
VRENO4814	4,8 x 14	5,407	50	8
VRENO4816	4,8 x 16	5,865	50	8
VRENO4818	4,8 x 18	6,693	50	8
VRENO4820	4,8 x 20	7,212	50	8
VRENO4822	4,8 x 22	3,961	25	8
VRENO4824	4,8 x 24	4,022	25	8
VRENO4830	4,8 x 30	4,851	25	8
VRENO4835	4,8 x 35	5,331	25	8



CÓDIGO	MEDIDA	€/100	Ø BROCA	ESPESOR MÁX. A FIJAR		
REIN3206	3,2 x 6,4	19,440	3,3	0,5 - 3	500	6.000
REIN3208	3,2 x 8	20,797	3,3	3 - 5	500	6.000
REIN3212	3,2 x 12,7	30,647	3,3	6,5 - 8,5	500	6.000
REIN3215	3,2 x 15,9	37,027	3,3	10,5 - 12,5	500	6.000
REIN4008	4 x 8,5	34,910	4,1	2,5 - 4,5	500	6.000
REIN4010	4 x 10,2	37,150	4,1	4,5 - 6,5	500	6.000
REIN4012	4 x 12	42,103	4,1	6,5 - 8,5	500	6.000
REIN4016	4 x 16	50,977	4,1	10 - 12	500	3.000
REIN4810	4,8 x 10,8	51,360	5	4 - 6	500	3.000
REIN4812	4,8 x 12	56,140	5	6 - 8	500	3.000
REIN4816	4,8 x 16	69,020	5	8 - 11	250	3.000
REIN4820	4,8 x 20,3	96,840	5	11 - 13	250	3.000
REIN4818	4,8 x 18	73,797	5	13 - 15	250	3.000

RE-IN

Cabeza alomada. Acero inoxidable A2



CÓDIGO	MEDIDA	€/100	Ø BROCA	ESPESOR MÁX. A FIJAR		
RECA4008	4 x 8	6,930	4,1	2 - 4	500	3.000
RECA4010	4 x 10	7,510	4,1	4 - 6	500	3.000
RECA4012	4 x 12	8,853	4,1	6 - 8	250	3.000
RECA4016	4 x 16	10,117	4,1	10 - 12	250	3.000
RECA4810	4,8 x 10	11,367	5	3,5 - 5,5	250	3.000
RECA4812	4,8 x 12	11,930	5	5,5 - 7,5	250	3.000
RECA4814	4,8 x 14	12,953	5	7,5 - 9,5	250	3.000
RECA4816	4,8 x 16	13,577	5	9,5 - 11,5	250	1.500
RECA4818	4,8 x 18	14,773	5	11,5 - 13,5	200	2.400

RE-CA

Cabeza ancha. Aluminio





Blíster



CÓDIGO	MEDIDA	€/BOLSA	PCS. 	BOLSAS 
BZRECA4010	4 x 10	2,029	8	15
BZRECA4012	4 x 12	2,029	8	15
BZRECA4016	4 x 16	2,029	8	15
BZRECA4810	4,8 x 10	2,029	8	15
BZRECA4812	4,8 x 12	2,029	8	15
BZRECA4814	4,8 x 14	2,029	8	15
BZRECA4816	4,8 x 16	2,029	8	15
BZRECA4818	4,8 x 18	2,029	5	15



Caja con Ventana

CÓDIGO	MEDIDA	€/CAJA	PCS. 	CAJAS 
VRECA4010	4 x 10	4,793	50	8
VRECA4012	4 x 12	4,083	35	8
VRECA4016	4 x 16	4,575	35	8
VRECA4810	4,8 x 10	3,751	25	8
VRECA4812	4,8 x 12	3,774	25	8
VRECA4814	4,8 x 14	4,278	25	8
VRECA4816	4,8 x 16	4,469	25	8
VRECA4818	4,8 x 18	3,892	20	8



CÓDIGO	MEDIDA	€/100	Ø BROCA	ESPESOR MÁX. A FIJAR		
RENO3208BL	3,2 x 8 9.003	7,823	3,3	3,5 - 5	500	6.000
RENO3210BL	3,2 x 10 9.003	8,270	3,3	5 - 7	500	6.000
RENO3212BL	3,2 x 12 9.003	8,677	3,3	7 - 9	500	6.000
RENO4008BL	4 x 8 9.003	9,533	4,1	3 - 5	500	6.000
RENO4010BL	4 x 10 9.003	10,317	4,1	5 - 6,5	500	6.000
RENO4012BL	4 x 12 9.003	10,690	4,1	6,5 - 8,5	500	6.000
RENO4014BL	4 x 14 9.003	11,753	4,1	8,5 - 10,5	500	6.000
RENO4810BL	4,8 x 10 9.003	14,127	4,9	4 - 6	500	3.000
RENO4812BL	4,8 x 12 9.003	14,857	4,9	6 - 8	500	3.000
RENO4814BL	4,8 x 14 9.003	16,210	4,9	8 - 10	250	3.000
RENO4816BL	4,8 x 16 9.003	16,870	4,9	10 - 12	250	3.000

RE-BL

Cabeza alomada blanca. Aluminio



RE

Remaches

RE-NE

Cabeza alomada negra. Aluminio

METAL



CÓDIGO	MEDIDA	€/100	Ø BROCA	ESPESOR MÁX. A FIJAR		
RENO3208NE	3,2 x 8 9.005	7,823	3,3	3,5 - 5	500	6.000
RENO3210NE	3,2 x 10 9.005	8,270	3,3	5 - 7	500	6.000
RENO3212NE	3,2 x 12 9.005	8,677	3,3	7 - 9	500	6.000
RENO4008NE	4 x 8 9.005	9,533	4,1	3 - 5	500	6.000
RENO4010NE	4 x 10 9.005	10,317	4,1	5 - 6,5	500	6.000
RENO4012NE	4 x 12 9.005	10,690	4	6,5 - 8,5	500	6.000
RENO4014NE	4 x 14 9.005	11,753	4,1	8,5 - 10,5	500	6.000
RENO4810NE	4,8 x 10 9.005	14,127	4,9	4 - 6	500	3.000
RENO4812NE	4,8 x 12 9.005	14,857	4,9	6 - 8	500	3.000
RENO4814NE	4,8 x 14 9.005	16,210	4,9	8 - 10	250	3.000
RENO4816NE	4,8 x 16 9.005	16,870	4,9	10 - 12	250	3.000

RE-FL

Cabeza alomada. Flor

METAL

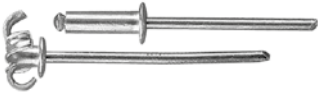

CÓDIGO	MEDIDA	€/100	Ø BROCA	ESPESOR MÁX. A FIJAR		
REFL4012	4 x 12,1	10,427	4,1	4 - 6,5	500	6.000
REFL4014	4 x 13,9	11,810	4,1	6 - 9	500	3.000
REFL4016	4 x 15,7	12,377	4,1	8 - 11	500	3.000
REFL4018	4 x 17,4	12,843	4,1	10 - 13	500	3.000
REFL4020	4 x 19,2	13,500	4,1	12 - 15	500	3.000
REFL4814	4,8 x 14,5	15,990	5	4 - 8	250	3.000
REFL4816	4,8 x 16,3	16,903	5	6 - 10	250	3.000
REFL4830	4,8 x 30	26,010	5	19 - 24	200	1.200
REFL4835	4,8 x 35	30,120	5	24 - 29	150	1.800
REFL4840	4,8 x 40	34,883	5	29 - 34	150	1.800
REFL4845	4,8 x 45	42,303	5		150	900
REFL4850	4,8 x 50	46,213	5		150	900
REFL4818	4,8 x 18	19,207	5	8 - 12	250	3.000
REFL4824	4,8 x 24	22,660	5	15 - 18	200	2.400
REFL4025	4 x 25	17,317	4,1	15 - 20	250	3.000



Blíster

CÓDIGO	MEDIDA	€/BOLSA	PCS.	BOLSAS
BZREFL4835	4,8 x 35	2,029	5	20





Caja con Ventana

CÓDIGO	MEDIDA	€/CAJA	PCS.	CAJAS
VREFL4835	4,8 x 35	9,440	25	8

Tuercas remachables

TR



CÓDIGO	MEDIDA	€/100	METAL	
				
TRAV0411	M4 x 11	17,060	500	12.000
TRAV0513	M5 x 13	18,297	500	6.000
TRAV0616	M6 x 16	22,867	500	3.000
TRAV0819	M8 x 19	26,760	250	3.000
TRAV1021	M10 x 21	40,790	250	1.500



TR-AV

Cabeza avellanada





CÓDIGO	MEDIDA	€/100	METAL	
				
TRCA0310	M3 x 10	11,887	500	12.000
TRCA0410	M4 x 10	24,770	500	12.000
TRCA0411	M4 x 11	24,770	500	12.000
TRCA0512	M5 x 12	26,600	500	12.000
TRCA0515	M5 x 15	26,600	500	6.000
TRCA0614	M6 x 14	33,357	250	3.000
TRCA0616	M6 x 16	33,357	250	3.000
TRCA0816	M8 x 16	24,693	250	3.000
TRCA0818	M8 x 18	25,547	250	1.500
TRCA1017	M10 x 17	40,800	250	1.500
TRCA1022	M10 x 22	42,230	250	1.500
TRCA1223	M12 x 23	68,387	250	1.000



TR-CA

Cabeza ancha



CÓDIGO	MEDIDA	€/100	METAL	
				
TRCR0410	M4 x 10	24,750	500	12.000
TRCR0511	M5 x 11	25,007	500	12.000
TRCR0614	M6 x 14	31,310	250	6.000
TRCR0815	M8 x 15	36,453	250	3.000
TRCR1019	M10 x 19	36,557	250	1.500



TR-CR

Cabeza reducida



RM

Remachadoras

METAL

RM-MA

Remachadora manual alicate



CÓDIGO	€/PC	VÁLIDO PARA	
RMMA01	25,825	1	40

RM-PA

Remachadora manual palanca



METAL

CÓDIGO	€/PC	VÁLIDO PARA	
RMPA01	180,535	1	10

RM-EX

Remachadora manual extensible



METAL

CÓDIGO	€/PC	VÁLIDO PARA	
RMEX01	168,131	1	5



ACCESORIOS PARA CABLE CADENA Y CERCADOS

U

SJ-Z

Sujetacable DIN 741. Cincado

SJ-Z

Sujetacable DIN 741. Cincado



METAL



CÓDIGO	METRICA	Ø CABLE	€/100	
SJZ0403	M4	d3	31,500	200
SJZ0505	M5	d5	36,400	200
SJZ0506	M5	d6 - 6,5	45,600	100
SJZ0608	M6	d8	65,600	100
SJZ0810	M8	d10	87,900	100
SJZ0811	M8	d11	112,100	100
SJZ1013	M10	d13	153,800	50
SJZ1014	M10	d14	177,100	50
SJZ1216	M12	d16	263,100	50
SJZ1220	M12	d20	334,100	25
SJZ1422	M14	d22	425,300	15
SJZ1426	M14	d26	599,100	15
SJZ1630	M16	d30	1.100,600	10
SJZ1634	M16	d34	1.292,900	10
SJZ1640	M16	d40	1.610,700	5



Blíster

CÓDIGO	MEDIDA	€/BOLSA	PCS. 	BOLSAS
BZSJZ0403	d3	4,622	4	20
BZSJZ0505	d5	4,622	2	20
BZSJZ0506	d6 - 6,5	4,622	2	20
BZSJZ0608	d8	4,622	2	20

TS-GA

Tensor gancho/anilla DIN-1480. Cincado

TS-GA

Tensor gancho/anilla DIN-1480.
Cincado



METAL



CÓDIGO	METRICA	Ø CABLE	€/100	
TSGA06	M6	1/4"	294,000	50
TSGA08	M8	5/16"	392,500	25
TSGA10	M10	3/8"	560,700	25
TSGA12	M12	1/2"	843,600	10
TSGA14	M14	9/16"	1.189,800	10
TSGA16	M16	5/8"	1.671,000	10
TSGA20	M20	3/4"	3.022,100	5
TSGA22	M22	7/8"	4.173,400	1
TSGA24	M24	1"	5.189,700	1
TSGA30	M30	1 1/4"	10.408,400	1
TSGA36	M36	1 1/2"	31.797,800	1



Blíster

CÓDIGO	MEDIDA	€/BOLSA	PCS. 	BOLSAS
BZTSGA06	1/4"	4,622	1	35

Tensores para cercado

CM-T

METAL



CÓDIGO	MEDIDA	€/100	
CMTENSOAL	85 x 29,5	126,497	250

CM-TENSO

Tensor de alambre



METAL



CÓDIGO	MEDIDA	€/100	
CMTENSOVE	85 x 29,5	197,603	250

CM-TENSOVE

Tensor de alambre verde



METAL



CÓDIGO	MEDIDA	€/100	
CMTENSOTO	Tornillo	119,119	450

CM-TT

Tensor de tornillo



Cáncamo hembra D-582. Cincado

EV-H

METAL

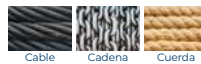

CÓDIGO	METRICA	Ø CABLE	€/100	
EVH06	M6	20	205,300	100
EVH08	M8	20	215,800	100
EVH10	M10	25	306,000	100
EVH12	M12	30	377,900	100
EVH14	M14	35	503,400	50
EVH16	M16	35	572,800	50
EVH18	M18	40	767,100	50
EVH20	M20	40	803,100	50
EVH22	M22	45	1.268,700	25
EVH24	M24	50	1.582,300	25
EVH30	M30	60	3.528,600	10
EVH36	M36	70	5.782,600	1

EV-H

Cáncamo hembra D-582. Cincado



EV-M

Cáncamo macho D-580. Cincado

EV-M

Cáncamo macho D-580. Cincado

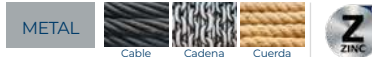

CÓDIGO	METRICA	Ø CABLE	€/100	
EVM08	M8	20	215,800	100
EVM10	M10	25	306,000	100
EVM12	M12	30	377,900	50
EVM14	M14	35	503,400	50
EVM16	M16	35	572,800	50
EVM18	M18	40	767,100	50
EVM20	M20	40	803,100	25
EVM22	M22	45	1.268,700	25
EVM24	M24	50	1.582,300	25
EVM30	M30	60	3.528,600	10
EVM36	M36	70	5.782,600	1
EVM42	M42	80	10.731,500	1
EVM48	M48	90	18.152,900	1

GR-Z

Grillete recto. Cincado

GR-Z

Grillete recto. Cincado

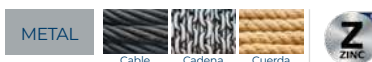

CÓDIGO	METRICA	Ø CABLE	€/100	
GRZ05	M5	10	110,600	50
GRZ06	M6	12	116,100	50
GRZ08	M8	16	146,300	50
GRZ10	M10	19	191,900	50
GRZ11	M11	22	331,700	25
GRZ12	M12	25	301,900	25
GRZ14	M14	28	462,900	25
GRZ16	M16	32	624,300	10
GRZ18	M18	36	968,600	5
GRZ20	M20	38	1.111,800	5
GRZ22	M22	44	1.481,000	1
GRZ25	M25	50	2.166,400	1
GRZ28	M28	56	3.221,600	1
GRZ32	M32	64	5.262,000	1
GRZ36	M36	70	10.104,500	1
GRZ42	M42	76	19.298,600	1
GRZ45	M45	80	25.651,200	1
GRZ50	M50	90	33.680,500	1

Blíster

CÓDIGO	MEDIDA	€/BOLSA	PCS.	BOLSAS
BZGRZ05	10	4,622	4	20
BZGRZ06	12	4,622	4	20
BZGRZ08	16	4,622	2	20
BZGRZ10	19	4,622	1	20



CÓDIGO	METRICA	Ø CABLE	€/100	
GDZ03	M3	12	43,200	200
GDZ04	M4	13	44,200	200
GDZ05	M5	14	50,300	200
GDZ06	M6	15	56,500	200
GDZ08	M8	18	62,300	100
GDZ10	M10	22	85,300	100
GDZ13	M13	28	182,000	50
GDZ15	M15	32	270,700	50
GDZ18	M18	40	625,800	50
GDZ20	M20	44	782,100	25
GDZ24	M24	48	961,000	10

GD-Z

Guardacabo DIN-6899/A. Cincado



Blíster

CÓDIGO	MEDIDA	€/BOLSA	PCS. 	BOLSAS
BZGDZ03	12	4,622	6	20
BZGDZ04	13	4,622	4	20
BZGDZ05	14	4,622	4	20
BZGDZ06	15	4,622	4	20



**NUEVA GAMA
CABLE/CADENA**

- GRILLETES
- SUJETACABLES
- TENSORES
- GUARDACABOS
- ANILLAS

CM

Accesorios para cercado

CM-BP

Brida poste

METAL



CÓDIGO	MEDIDA	€/100	
CMBRPOS33	33	173,632	250
CMBRPOS40	40	179,550	200
CMBRPOS42	42	182,417	200
CMBRPOS48	48	188,738	200
CMBRPOS50	50	191,545	200
CMBRPOS60	60	206,696	150

CM-BT

Brida tensor

METAL



CÓDIGO	MEDIDA	€/100	
CMBRTEN48	48	340,071	200

CM-TA

Tapón

METAL



CÓDIGO	MEDIDA	€/100	
CMTAPON33	33	80,413	500
CMTAPON40	40	88,281	350
CMTAPON42	42	91,662	350
CMTAPON48	48	101,847	300
CMTAPON50	50	113,575	250
CMTAPON60	60	131,768	250

CM-TP

Tapón poste

METAL



CÓDIGO	MEDIDA	€/100	
CMTAPOS33	33	217,273	100
CMTAPOS40	40	228,004	200
CMTAPOS42	42	228,669	200
CMTAPOS48	48	251,993	150

CM-UN

Uña

METAL



CÓDIGO	MEDIDA	€/100	
CMUNAAGUJ	Con agujero	25,116	1.500



FIJACIONES Y ACCESORIOS PARA PLACAS DE YESO



PL

Tornillo para placa de yeso de altas prestaciones. Fosfatado. Cabeza trompeta, rosca doble hilo y punta alfiler. Huella PH

PL-F

Tornillo

HUECOS



GRATIS - 1 punta en cada caja



CÓDIGO	MEDIDA	€/100		CAPACIDAD DE TALADRADO	UD. MIN. VENTA		
PL35019	3,5 x 19	2,493	PH2	< 0.6 mm	2.000	1.000	12.000
PL35025	3,5 x 25	2,340	PH2	< 0.6 mm	2.000	1.000	12.000
PL35035	3,5 x 35	3,101	PH2	< 0.6 mm	2.000	1.000	6.000
PL35045	3,5 x 45	3,714	PH2	< 0.6 mm	1.000	500	6.000
PL35055	3,5 x 55	4,760	PH2	< 0.6 mm	1.000	500	3.000
PL39025	3,9 x 25	2,896	PH2	< 0.6 mm	2.000	1.000	12.000
PL39035	3,9 x 35	4,019	PH2	< 0.6 mm	2.000	1.000	6.000
PL39045	3,9 x 45	5,067	PH2	< 0.6 mm	1.000	500	3.000
PL39055	3,9 x 55	6,065	PH2	< 0.6 mm	1.000	500	3.000
PL42070	4,2 x 70	9,152	PH2	< 0.6 mm	500	500	3.000
PL42080	4,2 x 80	11,770	PH2	< 0.6 mm	500	500	2.000
PL48090	4,8 x 90	20,021	PH2	< 0.6 mm	500	500	1.500
PL48100	4,8 x 100	25,194	PH2	< 0.6 mm	500	500	1.000
PL48110	4,8 x 110	27,856	PH2	< 0.6 mm	500	500	1.000
PL48120	4,8 x 120	30,849	PH2	< 0.6 mm	500	500	1.000
PL48130	4,8 x 130	33,896	PH2	< 0.6 mm	500	500	1.000



Blíster

CÓDIGO	MEDIDA	€/BOLSA	PCS.	BOLSAS
BZPL35025	3,5 x 25	2,565	50	10
BZPL35035	3,5 x 35	2,565	40	10
BZPL35045	3,5 x 45	2,565	25	10



Caja con Ventana

CÓDIGO	MEDIDA	€/CAJA	PCS.	CAJAS
VPL35025	3,5 x 25	7,517	250	8
VPL35035	3,5 x 35	9,503	250	8
VPL35045	3,5 x 45	7,179	150	8

PL-EP

Bote de plástico

HUECOS



CÓDIGO	MEDIDA	€/100		CAPACIDAD DE TALADRADO	UD. MIN. VENTA	PCS X BOTE
PLEP35025	3,5 x 25	93,616	PH2	< 0.6 mm	1 bote	4.000
PLEP35035	3,5 x 35	92,806	PH2	< 0.6 mm	1 bote	3.000





Tornillo para placa de yeso de paso ancho. Cabeza trompeta y punta perforante

PL-RA

HUECOS



CÓDIGO	MEDIDA	€/100		UD. MIN. VENTA		
PLRA3925	3,9 x 25	3,083	PH2	2.000	1.000	12.000
PLRA3935	3,9 x 35	4,074	PH2	2.000	1.000	6.000
PLRA3945	3,9 x 45	5,259	PH2	1.000	500	3.000
PLRA3955	3,9 x 55	5,524	PH2	1.000	500	3.000
PLRA4835	4,8 x 35	5,173	PH2	2.000	1.000	6.000



CE

Tornillo para placas de yeso laminado. Cabeza trompeta y punta autotaladrante

PL-TR

HUECOS



CÓDIGO	MEDIDA	€/100		CAPACIDAD DE TALADRADO	UD. MIN. VENTA		
PLTR3525	3,5 x 25	3,146	PH2	0,8 - 3 mm	2.000	1.000	12.000
PLTR3535	3,5 x 35	3,934	PH2	0,8 - 3 mm	2.000	1.000	6.000
PLTR3545	3,5 x 45	4,925	PH2	0,8 - 3 mm	1.000	500	6.000



CE

Tornillos para placa de yeso. Cabeza ancha

PL-CA

HUECOS



CÓDIGO	MEDIDA	€/100			
PLCAZ4213	4,2 x 13	3,436	PH2	1.000	12.000
PLCAZ4216	4,2 x 16	3,736	PH2	1.000	12.000
PLCAZ4219	4,2 x 19	4,020	PH2	1.000	12.000
PLCAZ4225	4,2 x 25	4,580	PH2	1.000	6.000
PLCAZ4232	4,2 x 32	5,676	PH2	500	6.000
PLCAZ4241	4,2 x 41	6,440	PH2	500	3.000
PLCAZ4251	4,2 x 51	7,296	PH2	200	2.400



CE

CP

Cintas para placas de yeso laminado

CP-PA

Cinta papel para juntas



HUECOS



Cartón yeso

CÓDIGO	LONGITUD ROLLO	ANCHURA	€/IPC	
CPPA023	23 m	50 mm	4,397	20
CPPA075	75 m	50 mm	8,450	20
CPPA150	150 m	50 mm	12,600	10

CE

CP-GV

Cinta guardavillos



HUECOS



Cartón yeso

CÓDIGO	LONGITUD ROLLO	€/IPC		
CPGV012	12,5 m	20,467	1	20
CPGV030	30 m	28,423	1	10

CE

CP-AC

Cinta acústica adhesiva



HUECOS



Cartón yeso

CÓDIGO	LONGITUD ROLLO	ANCHURA	€/IPC	
CPAC300453	30m x 45 x 3	45 mm	16,186	26
CPAC300703	30m x 70 x 3	70 mm	24,456	17

CP-MV

Cinta malla de vidrio



HUECOS



Cartón yeso

CÓDIGO	LONGITUD ROLLO	€/IPC	
CPMV020	20 m	4,129	100
CPMV045	45 m	7,773	64
CPMV090	90 m	15,813	36
CPMV150	150 m	21,963	16



Anclaje universal

OME

MULTIMATERIAL



CÓDIGO	MEDIDA	€/100		
OMEM06	M6	65,017	100	1.000



CE

Media abrazadera M6

MAB



CÓDIGO	MEDIDA	€/100		
MABM6018	18 (M6)	18,513	100	2.400



Horquilla de cuelgue

HO



CÓDIGO	MEDIDA	PERFIL	€/100		
HOCUM647	M6 (TC47)	TC 47	36,973	100	1.000

HO-CU

Por giro



CE



CÓDIGO	MEDIDA	PERFIL	€/100		
HOCRM647	M6 (TC47)	TC 47	53,853	100	1.000
HOCRM660	M6 (TC60)	TC 60	72,327	100	-

HO-CR

Recta



CE

EMP

Empalme de perfiles



CÓDIGO	PERFIL	€/100		
EMPTC45	TC 45	45,545	50	150
EMPTC47	TC 47	45,545	50	500
EMPTC60	TC 60	65,542	50	500

CE

CAB

Caballote para cruce de perfiles



CÓDIGO	PERFIL	€/100		
CABTC47	TC 47	65,090	50	400
CABTC60	TC 60	81,217	50	-

CE

ADU

Anclaje directo "U" para soporte de perfiles en falsos techos



CÓDIGO	PERFIL	€/100		
ADUTC47	TC 47	80,119	100	400
ADUTC60	TC 60	82,542	100	400



*El producto se suministrará sin plegar.

CE

PCU

Pletina de cuelgue



METAL



CÓDIGO	MEDIDA	€/100	UD. MIN. VENTA		
PCU0005	5	21,397	200	100	800
PCU0006	6	21,892	200	100	800

CE



Accesorio para suspensión

SUS



CÓDIGO	PERFIL	LONGITUD	€/100		
SUSTC47090	TC47	90	26,809	100	1.000
SUSTC47180	TC47	180	49,192	100	500
SUSTC47240	TC47	240	113,495	100	300
SUSTC47300	TC47	300	138,315	50	300
SUSTC47400	TC47	400	205,710	50	200



Trampillas de resgistro para placa de yeso laminado

TR



CÓDIGO	MEDIDA	€/PC	
TRBL200200	200 x 200	31,080	1
TRBL300300	300 x 300	42,985	1
TRBL400400	400 x 400	60,522	1
TRBL500500	500 x 500	85,332	1
TRBL600600	600 x 600	109,115	1

TR-BL

Lacada blanca (RAL 9016)



CÓDIGO	MEDIDA	GROSOR	€/PC	
TR13200200	200 x 200	13 mm	46,044	2
TR13300300	300 x 300	13 mm	56,172	2
TR13400400	400 x 400	13 mm	69,901	2
TR13500500	500 x 500	13 mm	87,667	1
TR13600600	600 x 600	13 mm	109,311	1

TR-13

13 mm



CÓDIGO	MEDIDA	GROSOR	€/PC	
TR15200200	200 x 200	15 mm	100,254	2
TR15300300	300 x 300	15 mm	111,711	2
TR15400400	400 x 400	15 mm	129,399	2
TR15500500	500 x 500	15 mm	156,237	1
TR15600600	600 x 600	15 mm	182,276	1

TR-15

15 mm





INDEX
A PERFECT FIXING

USE ONLY INDEX AVAILABLE TOOLS / USE YELLOW OR RED CARTRIDGES /
UTILISEZ SEULEMENT LES Outils INDEX / UTILISEZ CARTOUCHES
JAUNES OU ROUGES / USE CARTUCHES
AMARELOS OU VERMELHAS / UTILISEZ APENAS FERRAMENTAS INDEX

FIJACIÓN DIRECTA



FP-GUN

Pistola semiautomática para fijación a pólvora

FP08GUN

Para clavos de 8 mm



PÓLVORA



CÓDIGO	MEDIDA	€/PC	
FP08GUN	8mm	695,248	1

FP12GUN

Para clavos de 12 mm



PÓLVORA



CÓDIGO	MEDIDA	€/PC	
FP12GUN	12mm	1.347,667	1

**PISTOLAS
SUMINISTRADAS
CON MALETÍN
COMPLETO**

CONTENIDO MALETÍN

- Pistola
- Cepillo
- Manual de instrucciones
- Gafas protectoras
- Repuestos
- Aceite lubricante

FP-IM

Impulsores para pistolas de pólvora

FP-IP

Impulsores de pólvora



PÓLVORA

CÓDIGO	POTENCIA	COLOR	€/100	UDS X PEINE	
FPP3VE	POWER 3		28,393	10	100
FPP4AM	POWER 4		28,393	10	100
FPP5RO	POWER 5		28,393	10	100

FP-CR

Impulsores de pólvora en disco



PÓLVORA

CÓDIGO	POTENCIA	COLOR	€/100	UDS X DISCO	
FPCRAM	POWER 4		38,229	10	100
FPCRRO	POWER 5		38,229	10	100

Clavos para pistola FP08 a pólvora

FP-CL08

PÓLVORA

Chapa

Viga Ipn

CÓDIGO	MEDIDA	€/100		
FPCG0816	3,8 x 16	24,103	100	4.500
FPCG0819	3,8 x 19	26,753	100	4.500

FP-CG 08

Grafilados con arandela de goma

PÓLVORA

 Hormigón
armado

Hormigón

CÓDIGO	MEDIDA	€/100		
FPCL0816	3,8 x 16	11,370	100	4.500
FPCL0819	3,8 x 19	11,777	100	4.500
FPCL0825	3,8 x 25	11,857	100	4.500
FPCL0827	3,8 x 27	12,093	100	2.400
FPCL0832	3,8 x 32	12,687	100	2.400
FPCL0838	3,8 x 38	14,153	100	2.400
FPCL0844	3,8 x 44	15,143	100	2.400
FPCL0851	3,8 x 51	17,180	100	2.400
FPCL0857	3,8 x 57	17,747	100	2.400
FPCL0864	3,8 x 64	19,717	100	1.200
FPCL0870	3,8 x 70	20,537	100	1.200

FP-CL 08

Estándar con arandela de goma

PÓLVORA

 Hormigón
armado

Hormigón

CÓDIGO	MEDIDA	€/100		
FPAP085166	3,8 x 51	128,417	100	200

FP-AP 08

Estándar con arandela de plástico de 66 mm

PÓLVORA

 Hormigón
armado

Hormigón

CÓDIGO	MEDIDA	€/100		
FPC303708	3,8 x 37	54,723	100	100
FPC304708	3,8 x 47	56,660	100	100

FP-C30

Estándar con arandela de plástico de 35 mm

PÓLVORA

 Hormigón
armado

Hormigón

CÓDIGO	MEDIDA	€/100		
FPAM0837	3,8 x 37	32,833	100	600
FPAM0851	3,8 x 51	35,837	100	600

FP-AM 08

Estándar con arandela metálica de 36 mm



FP-CL08

Clavos para pistola FP08 a pólvora

FP-CR 08 M6

Estándar con rosca M6 x 8 para instalación de abrazaderas



CÓDIGO	MEDIDA	€/100		
FPCR0812*	3,8 x 12	28,823	100	2.400
FPCR0822	3,8 x 22	29,660	100	2.400
FPCR0827	3,8 x 27	30,120	100	2.400

* Válido para trabajar sobre acero

NEW FP-CR 08 M8

Estándar con rosca M8 x 8 para instalación de abrazaderas

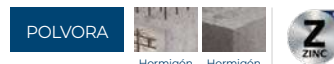

CÓDIGO	MEDIDA	€/100		
FPCRM80812*	3,8 x 12	38,047	100	-
FPCRM80827	3,8 x 27	40,662	100	-

* Válido para trabajar sobre acero

FP-PI 08

Clip abrazadera 13 mm con clavo y goma roja



CÓDIGO	MEDIDA	€/100		
FPPI081613	3,8 x 13	61,593	100	600

FP-CL12

Clavos para pistola FP12 a pólvora

FP-CG 12

Grafilados con arandela metálica de 12 mm



CÓDIGO	MEDIDA	€/100		
FPCG1612	3,8 x 16	14,847	100	4.500
FPCG1912	3,8 x 19	15,257	100	-

FP-CGD12

Grafilados con arandela doble metálica y plástica



CÓDIGO	MEDIDA	€/100		
FPCGD1612	3,8 x 16	18,677	100	100
FPCGD1912	3,8 x 19	19,180	100	100

FP-CL12

Estándar con arandela metálica de 12 mm



CÓDIGO	MEDIDA	€/100		
FPCL2212	3,8 x 22	14,090	100	-
FPCL2712	3,8 x 27	14,817	100	1.000
FPCL3212	3,8 x 32	15,630	100	1.000
FPCL3712	3,8 x 37	16,533	100	-
FPCL4212	3,8 x 42	17,520	100	-
FPCL4712	3,8 x 47	19,070	100	2.400

Clavos para pistola FP12 a pólvora

FP-CL12

PÓLVORA



CÓDIGO	MEDIDA	€/100	
FPCLD2212	3,8 x 22	18,270	100
FPCLD2712	3,8 x 27	19,210	100
FPCLD3212	3,8 x 32	20,300	100
FPCLD3712	3,8 x 37	21,473	100
FPCLD4212	3,8 x 42	22,730	100
FPCLD4712	3,8 x 47	24,717	100

FP-CLD12

Estándar con arandela doble metálica y plástica de 12 mm



PÓLVORA



CÓDIGO	MEDIDA	€/100	
FPCT3212	3,8 x 32	41,177	100

FP-CT12

Para instalación de falsos techos



Recambios para pistolas FP08GUN y FP12GUN

FP-PIS

PÓLVORA

CÓDIGO	MEDIDA	€/PC	
FPPIISCL08	8	56,364	1

Válido para clavos con cabeza cóncava. Ref: FP-AP y FP-C30

FP-PISCL08

Pistón para pistola FP08GUN



PÓLVORA

CÓDIGO	MEDIDA	€/PC	
FPPIISPL08	8	56,088	1

Válido para clavos con cabeza plana. Ref: FP-CG, FP-CL, FP-AM, FP-CR, FP-PI.

FP-PISPL08

Pistón plano para pistola FP08GUN



PÓLVORA

CÓDIGO	MEDIDA	€/PC	
FPPIISCL12	12	86,625	1

Válido para clavos con cabeza cóncava. Ref: FP-CG12, FP-CGD12, FP-CL12, FP-CLD12.

FP-PISCL12

Pistón para pistola FP12GUN



PÓLVORA

CÓDIGO	MEDIDA	€/PC	
FPPIISCM12	M6 x 8	94,927	1

Válido para clavos de Ø12, M6

FP-PISCM12

Pistón para pistola FP12GUN



PÓLVORA

CÓDIGO	MEDIDA	€/PC	
FPPIISCT12	12	97,454	1

Válido para clavo FPCT3212

FP-PISCT12

Pistón para pistola FP12GUN



FG-GUN

Pistola semiautomática de fijación a gas sin cables

GAS

FG-GUN

Pistola semiautomática de fijación a gas sin cables para tabiquería seca



CÓDIGO	MEDIDA	€/PC	
FG60GUN	Pistola gas	2.160,000	1



CONTENIDO MALETÍN

- Pistola de fijación a gas
- Cargador
- 2 baterías
- Llave Allen
- Manual de instrucciones



**PISTOLA SUMINISTRADA
CON MALETÍN COMPLETO**

- Técnica de anclaje directo para fijaciones ligeras: organizar cableados, colocar perfiles metálicos para la instalación de tabiques de placas de yeso, etc.
- Fijación de metal o madera a hormigón o bloque.
- Pistola suministrada con completo maletín, incluyendo cargador de batería.
- Baterías de larga duración.
- Capacidad para clavos de hasta 40 mm. de longitud.
- Carga de gas suministrada con los consumibles.

NEW FG-GUNEL

Pistola semiautomática de fijación a gas sin cables para electricistas

GAS



CÓDIGO	MEDIDA	€/PC	
FG60GUNEL	Pistola electricista	2.376,667	1

CONTENIDO MALETÍN

- Pistola de fijación a gas
- Cargador
- 2 baterías
- Llave Allen
- Manual de instrucciones
- Cañón para electricistas

Clavos para pistola de fijación a gas

FG-CL

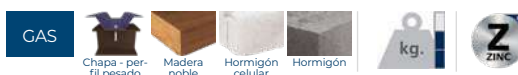

CÓDIGO	MEDIDA	€/100	
FGCL15	2,6 x 15	13,640	1.000
FGCL20	2,6 x 20	14,063	1.000
FGCL25	2,6 x 25	14,293	1.000
FGCL30	2,6 x 30	14,430	1.000
FGCL35	2,6 x 35	15,737	1.000
FGCL40	2,6 x 40	16,917	1.000

FG-CL

Clavos estándar



+ 1 CARTUCHO DE GAS

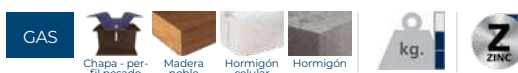

CÓDIGO	MEDIDA	€/100	
FGCLH15 NEW	3,1 x 15	15,533	1.000
FGCLH17	3,1 x 17	15,840	1.000
FGCLH19	3,1 x 19	15,840	1.000
FGCLH22	3,1 x 22	15,840	1.000
FGCLH27	3,1 x 27	16,573	1.000
FGCLH32	3,1 x 32	17,157	1.000

FG-CLH

Clavos para materiales duros.





+ 1 CARTUCHO DE GAS

Accesorios para instalar con pistola de gas

FG-AC

GAS

CÓDIGO	MEDIDA	€/100		
FGARAM25	Ø25	19,215	200	4.800

FG-ARAM **NEW**

Corona metálica para pistola de gas





GAS

CÓDIGO	MEDIDA	€/100		
FGARAM25EP	Ø25	20,368	1.000	-

FG-ARAM EP **NEW**

Corona metálica para pistola de gas.
Bote de plástico



CÓDIGO	MEDIDA	€/100		
FGPLET	M6 - M8	177,512	100	400

FG-PLET

Pletina roscada para varilla



FG-AC

Accesorios para instalar con pistola de gas

AB-PID

Grapa 1 pie para disparo



CÓDIGO	MEDIDA	€/100		
ABPID016	16	13,140	100	1.200
ABPID020	20	20,327	100	1.200
ABPID025	25	23,820	100	600
ABPID032	32	29,567	100	600

OME

Anclaje universal



CÓDIGO	MEDIDA	€/100		UNIDAD MÍNIMA DE VENTA
OMEM06	M6	65,017	100	1.000

CE

FG-ABRA

Abrazadera a presión



CÓDIGO	MEDIDA	€/100		
FGABRA15	15 - 18	59,578	100	-
FGABRA20	20 - 25	62,960	50	200
FGABRA25	25 - 32	75,703	50	-

INSTALACIÓN

PISTOLA



FG-BASE

Base para brida



CÓDIGO	MEDIDA	€/100		
FGBASENE		16,173	100	1.200
FGBASEGR NEW		16,659	100	1.200

Accesorios para pistola de gas

FG-APG

GAS

CÓDIGO	MEDIDA	€/PC	
FGCAEL	11	216,667	1

FG-CAEL NEW

Cañón de pistola especial para electricista



GAS

CÓDIGO	MEDIDA	€/PC	
FGCLCAR40	40	305,926	1

FG-CLCAR NEW

Cargador para 40 clavos



GAS

CÓDIGO	MEDIDA	€/PC	
FGIMAN	Øinterior 11,25	119,926	1

FG-IMAN

Imán



GAS

CÓDIGO	€/PC	
FG60BAT	283,333	1

FG-BAT

Batería para pistola FP60GUN



GAS

CÓDIGO	€/PC	
FG60CAR	239,221	1

FG-CAR

Cargador para pistola FP60GUN



GAS



CÓDIGO	€/PC		
FG60GAS	50,985	1	12

FG-GAS

Cartucho de gas





TORNILLOS PARA CUBIERTAS Y FACHADAS



DIN-7504-K

 Tornillo autotaladrante de cabeza hexagonal

DIN-7504-K

Tornillo



P.160

Disponible en diferentes colores



Disponible en varios recubrimientos. Consulte precio y plazo de entrega.



CÓDIGO	MEDIDA	€/100			
ABE3509	3,5 x 9,5	2,697	6	1.000	24.000
ABE3513	3,5 x 13	2,673	6	1.000	12.000
ABE3516	3,5 x 16	3,143	6	1.000	12.000
ABE3519	3,5 x 19	3,190	6	1.000	12.000
ABE4213	4,2 x 13	3,613	7	1.000	12.000
ABE4216	4,2 x 16	3,990	7	1.000	8.000
ABE4219	4,2 x 19	4,623	7	1.000	8.000
ABE4225	4,2 x 25	5,233	7	500	6.000
ABE4232	4,2 x 32	6,017	7	500	6.000
ABE4238	4,2 x 38	6,847	7	500	6.000
ABE4813	4,8 x 13	4,853	8	1.000	8.000
ABE4816	4,8 x 16	5,250	8	1.000	6.000
ABE4819	4,8 x 19	5,357	8	500	6.000
ABE4825	4,8 x 25	6,340	8	500	6.000
ABE4832	4,8 x 32	7,543	8	500	3.000
ABE4838	4,8 x 38	8,467	8	500	3.000
ABE5519	5,5 x 19	7,333	8	500	6.000
ABE5522	5,5 x 22	7,490	8	500	4.000
ABE5525	5,5 x 25	8,500	8	500	6.000
ABE5532	5,5 x 32	9,850	8	500	3.000
ABE5538	5,5 x 38	11,180	8	500	3.000
ABE5550	5,5 x 50	13,517	8	500	2.000

CÓDIGO	MEDIDA	€/100			
ABE5563	5,5 x 63	16,200	8	250	1.000
ABE5575	5,5 x 75	19,783	8	250	1.500
ABE6319	6,3 x 19	11,000	10	500	3.000
ABE6325	6,3 x 25	12,100	10	500	3.000
ABE6332	6,3 x 32	14,307	10	500	2.000
ABE6338	6,3 x 38	15,473	10	500	2.000
ABE6350	6,3 x 50	18,860	10	250	1.500
ABE6363	6,3 x 63	22,433	10	250	1.500
ABE6375	6,3 x 75	27,100	10	250	1.000
ABE6380	6,3 x 80	28,970	10	250	1.000
ABE6390	6,3 x 90	36,163	10	250	750
ABE6310	6,3 x 100	37,447	10	100	600
ABE6311	6,3 x 110	44,257	10	100	600
ABE6312	6,3 x 120	53,283	10	100	600
ABE6313	6,3 x 130	59,133	10	100	600
ABE6314	6,3 x 140	66,470	10	100	600
ABE6315	6,3 x 150	95,763	10	100	600
ABE6316	6,3 x 160	107,453	10	100	400
ABE6318	6,3 x 180	139,043	10	100	300
ABE6320	6,3 x 200	175,590	10	100	300
ABE6322	6,3 x 220	203,323	10	100	200
ABE6324	6,3 x 240	253,797	10	100	200



Blister

CÓDIGO	MEDIDA	€/BOLSA	PCS.	BOLSAS
BZABE3509	3,5 x 9,5	2,565	20	20
BZABE3513	3,5 x 13	2,565	20	20
BZABE4213	4,2 x 13	2,565	20	20
BZABE4216	4,2 x 16	2,565	20	20
BZABE4219	4,2 x 19	2,565	20	20
BZABE4225	4,2 x 25	2,565	10	20
BZABE4813	4,8 x 13	2,565	20	20
BZABE4816	4,8 x 16	2,565	20	20
BZABE4819	4,8 x 19	2,565	10	20
BZABE4825	4,8 x 25	2,565	10	20
BZABE4832	4,8 x 32	2,565	10	20
BZABE4838	4,8 x 38	2,565	10	20
BZABE5519	5,5 x 19	2,565	10	20
BZABE5522	5,5 x 22	2,565	10	20
BZABE5525	5,5 x 25	2,565	10	20
BZABE5532	5,5 x 32	2,565	10	20
BZABE5538	5,5 x 38	2,565	10	20
BZABE5550	5,5 x 50	2,565	10	20
BZABE6325	6,3 x 25	2,565	10	20
BZABE6332	6,3 x 32	2,565	10	20
BZABE6338	6,3 x 38	2,565	10	20
BZABE6350	6,3 x 50	2,565	5	20



Caja con Ventana

CÓDIGO	MEDIDA	€/CAJA	PCS.	CAJAS
VABE3509	3,5 x 9,5	6,358	225	8
VABE3513	3,5 x 13	6,659	200	8
VABE4213	4,2 x 13	6,637	150	8
VABE4216	4,2 x 16	7,261	150	8
VABE4219	4,2 x 19	8,567	150	8
VABE4225	4,2 x 25	4,984	75	8
VABE4232	4,2 x 32	5,888	75	8
VABE4813	4,8 x 13	8,912	150	8
VABE4816	4,8 x 16	9,843	150	8
VABE4819	4,8 x 19	10,728	150	8
VABE4825	4,8 x 25	12,104	150	8
VABE4832	4,8 x 32	10,055	110	8
VABE4838	4,8 x 38	8,877	85	8
VABE5519	5,5 x 19	11,330	125	8
VABE5522	5,5 x 22	11,910	125	8
VABE5525	5,5 x 25	13,136	125	8
VABE5532	5,5 x 32	10,351	85	8
VABE5538	5,5 x 38	10,843	80	8
VABE5550	5,5 x 50	9,824	60	8
VABE5563	5,5 x 63	7,890	40	8
VABE6319	6,3 x 19	13,610	100	8
VABE6325	6,3 x 25	13,221	90	8
VABE6332	6,3 x 32	12,163	70	8
VABE6338	6,3 x 38	11,277	60	8
VABE6350	6,3 x 50	9,161	40	8
VABE6363	6,3 x 63	7,008	25	8

DIN-7504-K A2

Tornillo. Inoxidable A2



CÓDIGO	MEDIDA	€/100			
ABEI4213	4,2 x 13	17,927	7	1.000	12.000
ABEI4216	4,2 x 16	20,113	7	1.000	8.000
ABEI4219	4,2 x 19	20,847	7	1.000	8.000
ABEI4813	4,8 x 13	25,360	8	1.000	8.000
ABEI4816	4,8 x 16	24,780	8	500	6.000
ABEI4819	4,8 x 19	26,817	8	500	6.000
ABEI4825	4,8 x 25	30,027	8	500	6.000
ABEI4832	4,8 x 32	35,707	8	500	3.000
ABEI5519	5,5 x 19	37,023	8	500	6.000
ABEI5522	5,5 x 22	39,500	8	500	4.000
ABEI5525	5,5 x 25	41,980	8	500	6.000
ABEI6319	6,3 x 19	56,113	10	500	3.000
ABEI6325	6,3 x 25	63,840	10	500	3.000

Tornillo autotaladrante de cabeza hexagonal
DIN-7504-K
METAL

CÓDIGO	MEDIDA	€/100			
ABE144219	4,2 x 19 P14	10,393	7	1.000	4.000
ABE144225	4,2 x 25 P14	12,297	7	500	3.000
ABE144816	4,8 x 16 P14	9,987	8	1.000	4.000
ABE144819	4,8 x 19 P14	10,712	8	1.000	4.000
ABE144825	4,8 x 25 P14	11,853	8	1.000	4.000
ABE144832	4,8 x 32 P14	16,297	8	500	3.000
ABE144838	4,8 x 38 P14	17,893	8	500	3.000
ABE145522	5,5 x 22 P14	14,253	8	1.000	4.000
ABE145532	5,5 x 32 P14	16,100	8	1.000	4.000
ABE164219	4,2 x 19 P16	12,857	7	1.000	4.000
ABE164816	4,8 x 16 P16	11,660	8	1.000	4.000
ABE164819	4,8 x 19 P16	11,652	8	1.000	3.000
ABE164825	4,8 x 25 P16	12,327	8	1.000	3.000
ABE164832	4,8 x 32 P16	17,197	8	500	3.000
ABE164838	4,8 x 38 P16	18,623	8	500	2.000
ABE165519	5,5 x 19 P16	13,580	8	1.000	3.000
ABE165522	5,5 x 22 P16	12,983	8	1.000	3.000
ABE165525	5,5 x 25 P16	15,143	8	1.000	3.000
ABE165532	5,5 x 32 P16	15,900	8	1.000	2.000
ABE165538	5,5 x 38 P16	18,023	8	1.000	2.000
ABE165550	5,5 x 50 P16	20,437	8	500	1.500
ABE165563	5,5 x 63 P16	23,867	8	250	1.500
ABE165575	5,5 x 75 P16	28,480	8	250	1.000
ABE166319	6,3 x 19 P16	17,493	10	500	3.000
ABE166325	6,3 x 25 P16	17,741	10	500	2.000
ABE166332	6,3 x 32 P16	22,153	10	500	2.000
ABE166338	6,3 x 38 P16	23,620	10	500	2.000
ABE166350	6,3 x 50 P16	28,007	10	500	1.000
ABE166363	6,3 x 63 P16	31,360	10	250	1.000
ABE166375	6,3 x 75 P16	38,447	10	250	750
ABE166380	6,3 x 80 P16	41,593	10	100	600
ABE166390	6,3 x 90 P16	49,400	10	100	600
ABE166310	6,3 x 100 P16	51,573	10	100	600
ABE166311	6,3 x 110 P16	57,817	10	100	600
ABE166312	6,3 x 120 P16	68,367	10	100	400
ABE166313	6,3 x 130 P16	74,553	10	100	400
ABE166314	6,3 x 140 P16	81,217	10	100	400

CÓDIGO	MEDIDA	€/100			
ABE184819	4,8 x 19 P18	15,357	8	500	3.000
ABE184825	4,8 x 25 P18	16,297	8	500	3.000
ABE184838	4,8 x 38 P18	20,147	8	500	2.000
ABE185522	5,5 x 22 P18	15,773	8	500	3.000
ABE185525	5,5 x 25 P18	17,520	8	500	3.000
ABE185532	5,5 x 32 P18	18,920	8	500	2.000
ABE185538	5,5 x 38 P18	20,200	8	500	2.000
ABE185550	5,5 x 50 P18	26,743	8	500	1.500
ABE185563	5,5 x 63 P18	25,763	8	250	1.000
ABE186319	6,3 x 19 P18	19,597	10	500	3.000
ABE186325	6,3 x 25 P18	19,267	10	500	2.000
ABE186332	6,3 x 32 P18	23,987	10	500	2.000
ABE186338	6,3 x 38 P18	23,447	10	250	1.500
ABE186350	6,3 x 50 P18	27,823	10	250	1.000
ABE186363	6,3 x 63 P18	32,853	10	250	1.000
ABE186375	6,3 x 75 P18	37,117	10	250	750
ABE186380	6,3 x 80 P18	46,767	10	100	600
ABE186390	6,3 x 90 P18	44,443	10	100	600
ABE186310	6,3 x 100 P18	48,547	10	100	400
ABE186311	6,3 x 110 P18	60,703	10	100	400
ABE186312	6,3 x 120 P18	72,847	10	100	400
ABE186313	6,3 x 130 P18	91,483	10	100	400
ABE186314	6,3 x 140 P18	100,720	10	100	400
ABE255522	5,5 x 22 P25	19,927	8	500	1.500
ABE255525	5,5 x 25 P25	23,917	8	500	1.500
ABE256325	6,3 x 25 P25	25,187	10	500	1.500
ABE256332	6,3 x 32 P25	30,413	10	500	1.000
ABE256338	6,3 x 38 P25	33,763	10	250	750
ABE256350	6,3 x 50 P25	38,097	10	250	750
ABE256363	6,3 x 63 P25	43,063	10	100	600
ABE256380	6,3 x 80 P25	54,107	10	100	300
ABE256390	6,3 x 90 P25	55,947	10	100	400
ABE256310	6,3 x 100 P25	60,933	10	100	400
ABE256311	6,3 x 110 P25	67,783	10	100	300
ABE256312	6,3 x 120 P25	74,723	10	100	300
ABE256313	6,3 x 130 P25	85,977	10	100	300
ABE256314	6,3 x 140 P25	94,013	10	100	200

DIN-7504-K + ARVUL

Tornillo con arandela vulcanizada de acero-EPDM

P.160

Disponible en diferentes colores



Disponible en varios recubrimientos. Consulte precio y plazo de entrega.

Blister

CÓDIGO	MEDIDA	€/BOLSA	PCS.	BOLSAS
BZABE144819	4,8 x 19 P14	2,565	18	10
BZABE144825	4,8 x 25 P14	2,565	18	10
BZABE164819	4,8 x 19 P16	2,565	18	10
BZABE165522	5,5 x 22 P16	2,565	15	10
BZABE165525	5,5 x 25 P16	2,565	15	10
BZABE165532	5,5 x 32 P16	2,565	12	10
BZABE165538	5,5 x 38 P16	2,565	12	10
BZABE165550	5,5 x 50 P16	2,565	10	10
BZABE166325	6,3 x 25 P16	2,565	10	10
BZABE166332	6,3 x 32 P16	2,565	8	10
BZABE166338	6,3 x 38 P16	2,565	8	10

Caja con Ventana

CÓDIGO	MEDIDA	€/CAJA	PCS.	CAJAS
VABE144819	4,8 x 19 P14	13,048	100	8
VABE144825	4,8 x 25 P14	11,564	80	8
VABE164819	4,8 x 19 P16	9,532	70	8
VABE165522	5,5 x 22 P16	10,516	70	8
VABE165525	5,5 x 25 P16	10,914	60	8
VABE165532	5,5 x 32 P16	9,431	50	8
VABE165538	5,5 x 38 P16	9,604	45	8
VABE165550	5,5 x 50 P16	8,448	35	8
VABE166325	6,3 x 25 P16	10,263	50	8
VABE166332	6,3 x 32 P16	13,349	50	8
VABE166338	6,3 x 38 P16	11,379	40	8

METAL

CÓDIGO	MEDIDA	€/BOTE		PCS X BOTE
ABE144819CP	4,8 x 19 P14	139,268	8	1.250
ABE164819CP	4,8 x 19 P16	143,962	8	1.250
ABE165522CP	5,5 x 22 P16	168,822	8	1.250
ABE166325CP	6,3 x 25 P16	138,377	10	750

DIN-7504-K CP + ARVUL

Bote de plástico



AUTO

Tornillo para viga autotaladrante con cabeza hexagonal

AUTO

Tornillo



CÓDIGO	MEDIDA	€/100		ESPOSOR MÁX. A FIJAR	CAPACIDAD DE TALADRADO		
AUTO532	5,5 x 32	16,193	8	16	4,00-12,00	500	3.000
AUTO538	5,5 x 38	17,700	8	22	4,00-12,00	500	3.000



Disponible en varios recubrimientos. Consulte precio y plazo de entrega.

AUTO + ARVUL

Tornillo con arandela vulcanizada de acero-EPDM



CÓDIGO	MEDIDA	€/100		ESPOSOR MÁX. A FIJAR	CAPACIDAD DE TALADRADO		
AUTO16532	5,5 x 32 P16	20,030	8	14	4,00-12,00	500	2.000
AUTO16538	5,5 x 38 P16	21,330	8	20	4,00-12,00	500	2.000



Disponible en varios recubrimientos. Consulte precio y plazo de entrega.

ABE BIMETAL

Tornillo autotaladrante inoxidable bimetálico con cabeza hexagonal

ABE BIMETAL

Tornillo



CÓDIGO	MEDIDA	€/100		CAPACIDAD DE TALADRADO		
BIE4825	4,8 x 25	75,343	8	1,75-4,40	500	6.000
BIE5525	5,5 x 25	86,440	8	1,75-5,25	500	6.000
BIE5532	5,5 x 32	101,427	8	1,75-5,25	500	3.000
BIE5538	5,5 x 38	105,547	8	1,75-5,25	500	3.000
BIE5550	5,5 x 50	121,823	8	1,75-5,25	500	2.000
BIE5558	5,5 x 58	135,590	8	1,75-5,25	250	1.500
BIE5565	5,5 x 65	141,720	8	1,75-5,25	250	1.500
BIE5580	5,5 x 80	167,200	8	1,75-5,25	250	1.000
BIE6325	6,3 x 25	92,240	10	2,50-6,00	500	3.000

ABE BIMETAL + ARVUL

Tornillo con arandela vulcanizada de acero-EPDM



CÓDIGO	MEDIDA	€/100		CAPACIDAD DE TALADRADO		
BIE164825	4,8 x 25 P16	88,448	8	1,75-4,40	500	2.000
BIE165525	5,5 x 25 P16	102,467	8	1,75-5,25	500	2.000
BIE165532	5,5 x 32 P16	119,110	8	1,75-5,25	500	2.000
BIE165538	5,5 x 38 P16	122,609	8	1,75-5,25	500	1.500
BIE165550	5,5 x 50 P16	143,010	8	1,75-5,25	500	1.500
BIE165558	5,5 x 58 P16	153,868	8	1,75-5,25	250	1.500
BIE165565	5,5 x 65 P16	160,132	8	1,75-5,25	250	1.500
BIE165580	5,5 x 80 P16	186,347	8	1,75-5,25	250	1.000
BIE166325	6,3 x 25 P16	108,997	10	2,50-6,00	500	2.000



CABEZA Y CUERPO INOXIDABLE A2

PUNTA DE ACERO TEMPLADO

BIMETAL

INOX TECHNOLOGY

Los beneficios del tornillo broca de acero con la durabilidad anticorrosión de un inoxidable

RECUBRIMIENTO ATLANTIS C3-H



Tornillo viga autotaladrante inoxidable bimet con cabeza hexagonal

AUTO BIMETAL



CÓDIGO	MEDIDA	€/100		ESPEJOR MÁX. A FIJAR	CAPACIDAD DE TALADRADO		
BAUTO5540	5,5 x 40	128,757	8	10	4,00-12,00	500	3.000
BAUTO5550	5,5 x 50	182,827	8	20	4,00-12,00	500	3.000
BAUTO5565	5,5 x 65	190,993	8	35	4,00-12,00	250	1.500
BAUTO5580	5,5 x 80	240,070	8	50	4,00-12,00	250	1.000
BAUTO5510	5,5 x 100	242,763	8	70	4,00-12,00	100	600

AUTO BIMETAL

Tornillo



CÓDIGO	MEDIDA	€/100		ESPEJOR MÁX. A FIJAR	CAPACIDAD DE TALADRADO		
BAUTO165540	5,5 x 40 P16	155,930	8	8	4,00-12,00	500	1.500
BAUTO165550	5,5 x 50 P16	210,793	8	18	4,00-12,00	500	1.500
BAUTO165565	5,5 x 65 P16	217,797	8	33	4,00-12,00	250	1.500
BAUTO165580	5,5 x 80 P16	255,990	8	48	4,00-12,00	250	1.000
BAUTO165510	5,5 x 100 P16	269,887	8	68	4,00-12,00	100	600

AUTO BIMETAL + ARVUL

Tornillo con arandela vulcanizada de acero-EPDM



Tornillo autotaladrante de punta reducida y cabeza hexagonal de 8 mm

DIN-7504-K RE



CÓDIGO	MEDIDA	€/100			
ARE4816	4,8 x 16	6,080	8	500	6.000
ARE4819	4,8 x 19	6,520	8	500	6.000
ARE5522	5,5 x 22	9,373	8	500	4.000
ARE6320	6,3 x 20	10,390	8	500	3.000
ARE6325	6,3 x 25	12,197	8	500	3.000
ARE6332	6,3 x 32	16,013	8	500	3.000
ARE6338	6,3 x 38	17,090	8	500	3.000
ARE6350	6,3 x 50	20,830	8	250	1.500
ARE6363	6,3 x 63	25,070	8	250	1.500
ARE6380	6,3 x 80	32,803	8	250	1.000

DIN-7504-K RE

Tornillo



P160
Disponible en diferentes colores

Disponible en varios recubrimientos.
Consulte precio y plazo de entrega.

DIN-7504-K RE

Tornillo autotaladrante de punta reducida y cabeza hexagonal de 8 mm

DIN-7504-K RE + ARVUL

Tornillo con arandela vulcanizada de acero-EPDM



P160

Disponible en diferentes colores



Disponible en varios recubrimientos. Consulte precio y plazo de entrega.



CÓDIGO	MEDIDA	€/100			
ARE164816	4,8 x 16 P16	15,070	8	500	3.000
ARE164819	4,8 x 19 P16	15,763	8	500	3.000
ARE165522	5,5 x 22 P16	17,820	8	500	3.000
ARE166320	6,3 x 20 P16	17,547	8	500	3.000
ARE166325	6,3 x 25 P16	19,163	8	500	3.000
ARE166332	6,3 x 32 P16	26,803	8	500	2.000
ARE166338	6,3 x 38 P16	25,993	8	500	2.000
ARE166350	6,3 x 50 P16	30,773	8	250	1.500

Para espesores inferiores a 1,5 mm

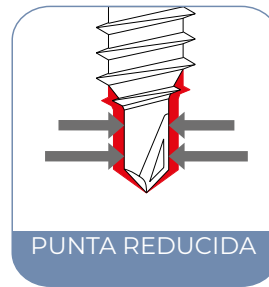

AUE

Tornillo rosca chapa con cabeza hexagonal

AUE

Tornillo



P160

Disponible en diferentes colores



Disponible en varios recubrimientos. Consulte precio y plazo de entrega.



CÓDIGO	MEDIDA	€/100			
AUE6319	6,3 x 19	8,940	10	500	3.000
AUE6325	6,3 x 25	9,680	10	500	3.000
AUE6332	6,3 x 32	11,483	10	500	2.000
AUE6340	6,3 x 40	12,807	10	500	2.000
AUE6350	6,3 x 50	14,740	10	500	1.500
AUE6360	6,3 x 60	17,803	10	250	1.000
AUE6380	6,3 x 80	23,840	10	250	1.000
AUE6310	6,3 x 100	31,070	10	250	750
AUE6311	6,3 x 110	37,570	10	250	750
AUE6312	6,3 x 120	40,103	10	250	750
AUE6313	6,3 x 130	49,307	10	250	750
AUE6314	6,3 x 140	56,527	10	250	500
AUE6315	6,3 x 150	69,480	10	100	400

AUE + ARVUL

Tornillo con arandela vulcanizada de acero-EPDM



P160

Disponible en diferentes colores



Disponible en varios recubrimientos. Consulte precio y plazo de entrega.



CÓDIGO	MEDIDA	€/100			
AUE166319	6,3 x 19 P16	15,953	10	500	2.000
AUE166325	6,3 x 25 P16	16,900	10	500	2.000
AUE166332	6,3 x 32 P16	18,747	10	500	2.000
AUE166340	6,3 x 40 P16	20,827	10	500	1.500
AUE166350	6,3 x 50 P16	23,227	10	500	1.500
AUE166360	6,3 x 60 P16	28,320	10	250	1.000
AUE166380	6,3 x 80 P16	36,137	10	250	750
AUE186325	6,3 x 25 P18	18,050	10	500	2.000
AUE186332	6,3 x 32 P18	20,707	10	500	1.500
AUE186340	6,3 x 40 P18	25,103	10	500	1.500
AUE186350	6,3 x 50 P18	25,430	10	500	1.500
AUE186360	6,3 x 60 P18	30,620	10	250	1.000
AUE186380	6,3 x 80 P18	39,693	10	250	750
AUE186310	6,3 x 100 P18	46,347	10	250	750
AUE186311	6,3 x 110 P18	52,520	10	250	500
AUE186312	6,3 x 120 P18	60,410	10	100	400
AUE186313	6,3 x 130 P18	70,613	10	100	400
AUE186314	6,3 x 140 P18	76,647	10	100	400
AUE186315	6,3 x 150 P18	78,507	10	100	400
AUE256325	6,3 x 25 P25	29,010	10	500	1.500



Tornillo autotaladrante de cabeza hexagonal para panel sándwich

PS



CÓDIGO	MEDIDA	€/100		ESPESOR MÁX. A FIJAR	CAPACIDAD DE TALADRADO		
PS55060	5,5 / 6,3 x 60	19,497	8	31 - 45	1,50-6,00	500	1.500
PS55082	5,5 / 6,3 x 82	26,503	8	43 - 67	1,50-6,00	500	1.000
PS55098	5,5 / 6,3 x 98	31,953	8	54 - 83	1,50-6,00	500	1.000
PS55115	5,5 / 6,3 x 115	36,380	8	56 - 100	1,50-6,00	500	1.000
PS55130 *	5,5 / 6,3 x 130	64,840	8	66 - 115	1,50-6,00	200	400
PS55150 *	5,5 / 6,3 x 150	85,763	8	86 - 135	1,50-6,00	200	400
PS55180 *	5,5 / 6,3 x 180	142,820	8	116 - 165	1,50-6,00	200	400

* Disponible con arandela vulcanizada de acero-EPDM



CÓDIGO	MEDIDA	€/100		ESPESOR MÁX. A FIJAR	CAPACIDAD DE TALADRADO		
PS1655060	5,5 / 6,3 x 60 P16	25,613	8	31 - 45	1,50-6,00	500	1.000
PS1655082	5,5 / 6,3 x 82 P16	32,017	8	43 - 67	1,50-6,00	500	1.000
PS1655098	5,5 / 6,3 x 98 P16	38,007	8	54 - 83	1,50-6,00	500	1.000
PS1655115	5,5 / 6,3 x 115 P16	43,943	8	56 - 100	1,50-6,00	500	-



CÓDIGO	MEDIDA	€/100		ESPESOR MÁX. A FIJAR	CAPACIDAD DE TALADRADO		
PS1955195	5,5 / 6,3 x 195 P19	289,230	8	130 - 185	1,50-6,00	200	400
PS1955230	5,5 / 6,3 x 230 P19	406,007	8	166 - 215	1,50-6,00	200	-



CÓDIGO	MEDIDA	€/100		ESPESOR MÁX. A FIJAR	CAPACIDAD DE TALADRADO		
PSL55075	5,5 / 6,3 x 75	27,263	8	33 - 60	6,00-12,00	500	1.500
PSL55085	5,5 / 6,3 x 85	31,893	8	38 - 70	6,00-12,00	500	1.000
PSL55105	5,5 / 6,3 x 105	39,840	8	48 - 90	6,00-12,00	500	1.000
PSL55130	5,5 / 6,3 x 130	58,430	8	63 - 115	6,00-12,00	250	750
PSL55150	5,5 / 6,3 x 150	69,183	8	83 - 135	6,00-12,00	250	750
PSL55175 *	5,5 / 6,3 x 175	135,077	8	108 - 160	6,00-12,00	200	400

* Disponible con arandela vulcanizada de acero-EPDM

PSL55200 *	5,5 / 6,3 x 200	162,993	8	133 - 185	6,00-12,00	200	400
PSL55230 *	5,5 / 6,3 x 230	229,967	8	163 - 215	6,00-12,00	200	400

* Disponible con arandela vulcanizada de acero-EPDM



CÓDIGO	MEDIDA	€/100		ESPESOR MÁX. A FIJAR	CAPACIDAD DE TALADRADO		
PSL1655075	5,5 / 6,3 x 75 P16	33,170	8	33 - 60	6,00-12,00	500	1.000
PSL1655085	5,5 / 6,3 x 85 P16	38,430	8	38 - 70	6,00-12,00	500	1.000
PSL1655105	5,5 / 6,3 x 105 P16	46,370	8	48 - 90	6,00-12,00	500	-
PSL1655130	5,5 / 6,3 x 130 P16	65,540	8	63 - 115	6,00-12,00	250	500
PSL1655150	5,5 / 6,3 x 150 P16	76,293	8	83 - 135	6,00-12,00	250	500



CÓDIGO	MEDIDA	€/100		ESPESOR MÁX. A FIJAR	CAPACIDAD DE TALADRADO		
PSL1955255	5,5 / 6,3 x 255 P19	565,423	8	170 - 210	6,00-12,00	200	-
PSL1955285	5,5 / 6,3 x 285 P19	993,677	8	200 - 250	6,00-12,00	200	-

PS 3

Punta broca estándar #3. Cincado



PS 3 + ARVUL

Punta broca estándar #3 con arandela vulcanizada de acero-EPDM. Cincado



PS 3 + ARVUL A2

Punta broca estándar #3 con recubrimiento ATLANTIS C4-M y arandela inoxidable A2



PS 5

Punta broca extra larga #5. Cincado



PS 5 + ARVUL

Punta broca extra larga #5 con arandela vulcanizada de acero-EPDM. Cincado



PS 5 + ARVUL A2

Punta broca extra larga #5 con recubrimiento ATLANTIS C4-M y arandela inoxidable A2



FIBR

Tornillo autotaladrante para fibrocemento, montado con arandela paraguas

METAL



CÓDIGO	MEDIDA	€/100		ESPESOR MÁX. A FIJAR	CAPACIDAD DE TALADRADO	
FI63115	6,3 x 115	87,723	8	85	1,00-6,00	250
FI63125	6,3 x 125	93,363	8	95	1,00-6,00	250
FI63110	6,3 x 110	98,370	8	75	6,00-12,00	250
FI63120	6,3 x 120	100,490	8	85	6,00-12,00	250
FI63130	6,3 x 130	106,973	8	95	6,00-12,00	250
FI63150	6,3 x 150	106,960	8	115	6,00-12,00	250
FI63160	6,3 x 160	132,547	8	125	6,00-12,00	250

ARVUL

Arandela vulcanizada de acero-EPDM

METAL



ARVUL

Recubrimiento ATLANTIS C2-M



CÓDIGO	MEDIDA	€/100	Ø INTERIOR ARANDELA		
ARANE14	P14	4,363	2,5	1.000	12.000
ARANE16	P16	4,880	2,7	1.000	6.000
ARANE18	P18	6,213	3,2	1.000	6.000
ARANE25	P25	10,637	3,3	500	3.000



Blister



Caja con Ventana

CÓDIGO	MEDIDA	€/BOLSA	PCS.	BOLSAS
BZARANE14	P14	2,029	20	10
BZARANE16	P16	2,029	20	10
BZARANE18	P18	2,029	20	10

CÓDIGO	MEDIDA	€/CAJA	PCS.	CAJAS
VARANE14	P14	5,283	100	8
VARANE16	P16	5,860	100	8
VARANE18	P18	7,687	100	8
VARANE25	P25	13,314	100	8

ARVUL A2

Inoxidable A2



INOXIDABLE



CÓDIGO	MEDIDA	€/100	Ø INTERIOR ARANDELA		
ARINO14	P14	12,053	2,5	1.000	12.000
ARINO16	P16	13,627	2,7	1.000	6.000
ARINO18	P18	17,147	3,2	1.000	6.000
ARINO25	P25	31,707	3,3	500	3.000
ARINOM30	P30	45,500	6,3	500	1.500



* ARINOM30: Especial instalaciones con anclaje MTH-A2, Ø6.

ATAP

Tapón de nylon de colores para tornillos con cabeza hexagonal



CÓDIGO		COLOR	€/100		
ATAPO08AR	8	RAL 1.001	7,197	1.000	2.000
ATAPO08RC	8	RAL 3.003	7,197	1.000	2.000
ATAPO08RT	8	RAL 3.011	7,197	1.000	2.000
ATAPO08VN	8	RAL 6.028	7,197	1.000	2.000
ATAPO08BP	8	RAL 9.010	7,197	1.000	2.000
ATAPO08NE	8	RAL 9.005	7,197	1.000	2.000
ATAPO08BO	8	RAL 9.002	7,197	1.000	2.000
ATAPO10AR	10	RAL 1.001	7,197	1.000	2.000
ATAPO10RC	10	RAL 3.003	7,197	1.000	2.000
ATAPO10RT	10	RAL 3.011	7,197	1.000	2.000
ATAPO10VN	10	RAL 6.028	7,197	1.000	2.000
ATAPO10BP	10	RAL 9.010	7,197	1.000	2.000
ATAPO10NE	10	RAL 9.005	7,197	1.000	2.000
ATAPO10BO	10	RAL 9.002	7,197	1.000	2.000



TORNILLOS BROCA, ROSCA CHAPA Y PVC



DIN-7504-N Tornillo autotaladrante de cabeza alomada

DIN-7504-N HP Z

Cincado. Huella PH



Disponible en varios recubrimientos. Consulte precio y plazo de entrega.



CÓDIGO	MEDIDA	€/100	ESPESOR MÁX. A FIJAR	CAPACIDAD DE TALADRADO	1000	24.000
ABR3509	3,5 x 9,5	1,770	PH2	2,8	0,70-2,25	1.000 24.000
ABR3511	3,5 x 11	2,063	PH2	4,2	0,70-2,25	1.000 24.000
ABR3513	3,5 x 13	2,150	PH2	6,2	0,70-2,25	1.000 24.000
ABR3516	3,5 x 16	2,297	PH2	9,2	0,70-2,25	1.000 16.000
ABR3519	3,5 x 19	2,457	PH2	12,1	0,70-2,25	1.000 12.000
ABR3522	3,5 x 22	2,750	PH2	15,1	0,70-2,25	1.000 12.000
ABR3525	3,5 x 25	3,030	PH2	18,1	0,70-2,25	500 12.000
ABR3532	3,5 x 32	3,797	PH2	25,1	0,70-2,25	500 6.000
ABR3913	3,9 x 13	2,577	PH2	5,8	0,70-2,40	1.000 16.000
ABR3916	3,9 x 16	2,770	PH2	8,8	0,70-2,40	1.000 12.000
ABR3919	3,9 x 19	3,080	PH2	11,7	0,70-2,40	1.000 12.000
ABR3925	3,9 x 25	3,723	PH2	17,7	0,70-2,40	500 8.000
ABR3932	3,9 x 32	4,480	PH2	24,5	0,70-2,40	500 6.000
ABR4213	4,2 x 13	2,740	PH2	4,3	1,75-3,00	1.000 12.000
ABR4216	4,2 x 16	3,000	PH2	7,3	1,75-3,00	1.000 12.000
ABR4219	4,2 x 19	3,397	PH2	10,3	1,75-3,00	1.000 12.000
ABR4222	4,2 x 22	3,863	PH2	13,3	1,75-3,00	500 8.000
ABR4225	4,2 x 25	4,010	PH2	17,7	1,75-3,00	500 6.000
ABR4232	4,2 x 32	4,700	PH2	24,5	1,75-3,00	500 6.000
ABR4238	4,2 x 38	5,523	PH2	30,5	1,75-3,00	500 6.000
ABR4250	4,2 x 50	6,920	PH2	41	1,75-3,00	500 3.000
ABR4813	4,8 x 13	3,883	PH2	3,7	1,75-4,40	1.000 8.000
ABR4816	4,8 x 16	4,230	PH2	5,5	1,75-4,40	1.000 8.000
ABR4819	4,8 x 19	4,667	PH2	10,3	1,75-4,40	1.000 8.000
ABR4822	4,8 x 22	5,417	PH2	11,7	1,75-4,40	500 6.000
ABR4825	4,8 x 25	5,523	PH2	14,7	1,75-4,40	500 6.000
ABR4832	4,8 x 32	6,317	PH2	21,5	1,75-4,40	500 6.000
ABR4838	4,8 x 38	7,293	PH2	27,5	1,75-4,40	500 3.000
ABR4845	4,8 x 45	8,480	PH2	34,5	1,75-4,40	500 3.000
ABR4850	4,8 x 50	9,537	PH2	39,5	1,75-4,40	500 3.000
ABR4860	4,8 x 60	12,743	PH2	49,5	1,75-4,40	500 2.000
ABR4880	4,8 x 80	16,640	PH2	69,5	1,75-4,40	250 1.500
ABR4890	4,8 x 90	26,210	PH2	79,5	1,75-4,40	100 1.200
ABR4810	4,8 x 100	29,577	PH2	89,5	1,75-4,40	100 1.200
ABR4811	4,8 x 110	30,590	PH2	-	1,75-4,40	100 1.200
ABR4812	4,8 x 120	31,510	PH2	-	1,75-4,40	100 1.200
ABR5519	5,5 x 19	6,440	PH3	8,7	1,75-5,25	500 6.000
ABR5522	5,5 x 22	6,943	PH3	11,7	1,75-5,25	500 6.000
ABR5525	5,5 x 25	7,217	PH3	14,7	1,75-5,25	500 4.000
ABR5532	5,5 x 32	8,593	PH3	21,5	1,75-5,25	500 3.000
ABR5538	5,5 x 38	9,667	PH3	27,5	1,75-5,25	500 3.000
ABR5545	5,5 x 45	10,850	PH3	34,5	1,75-5,25	500 3.000
ABR5560	5,5 x 60	15,163	PH3	49,5	1,75-5,25	250 1.500
ABR5573	5,5 x 73	18,287	PH3	62,5	1,75-5,25	250 1.500

Blister

CÓDIGO	MEDIDA	€/BOLSA	PCS.	BOLSAS
BZABR3509	3,5 x 9,5	2,565	40	15
BZABR3513	3,5 x 13	2,565	40	15
BZABR3516	3,5 x 16	2,565	40	15
BZABR4213	4,2 x 13	2,565	40	15
BZABR4216	4,2 x 16	2,565	40	15
BZABR4219	4,2 x 19	2,565	40	15
BZABR4225	4,2 x 25	2,565	20	15
BZABR4232	4,2 x 32	2,565	20	15
BZABR4816	4,8 x 16	2,565	35	15
BZABR4819	4,8 x 19	2,565	35	15
BZABR4825	4,8 x 25	2,565	20	15
BZABR4832	4,8 x 32	2,565	20	15
BZABR4838	4,8 x 38	2,565	20	15
BZABR4845	4,8 x 45	2,565	20	15
BZABR4850	4,8 x 50	2,565	20	15
BZABR4860	4,8 x 60	2,565	20	15

Caja con Ventana

CÓDIGO	MEDIDA	€/CAJA	PCS.	CAJAS
VABR3509	3,5 x 9,5	6,179	275	8
VABR3511	3,5 x 11	6,296	250	8
VABR3513	3,5 x 13	6,637	250	8
VABR3516	3,5 x 16	6,449	225	8
VABR3519	3,5 x 19	6,823	225	8
VABR3525	3,5 x 25	6,789	180	8
VABR3913	3,9 x 13	7,878	250	8
VABR3916	3,9 x 16	6,953	200	8
VABR3919	3,9 x 19	7,451	200	8
VABR3925	3,9 x 25	6,945	150	8
VABR3932	3,9 x 32	11,152	200	8
VABR4213	4,2 x 13	6,967	200	8
VABR4216	4,2 x 16	7,407	200	8
VABR4219	4,2 x 19	7,350	175	8
VABR4222	4,2 x 22	8,148	175	8
VABR4225	4,2 x 25	6,193	125	8
VABR4232	4,2 x 32	5,419	90	8
VABR4238	4,2 x 38	5,298	75	8
VABR4250	4,2 x 50	4,875	50	8
VABR4813	4,8 x 13	6,385	125	8
VABR4816	4,8 x 16	6,471	125	8
VABR4819	4,8 x 19	6,249	110	8
VABR4822	4,8 x 22	6,018	90	8
VABR4825	4,8 x 25	6,135	90	8
VABR4832	4,8 x 32	5,957	75	8
VABR4838	4,8 x 38	5,183	55	8
VABR4845	4,8 x 45	5,378	50	8
VABR4850	4,8 x 50	4,931	40	8
VABR4860	4,8 x 60	6,405	40	8
VABR4880	4,8 x 80	5,584	25	8
VABR5532	5,5 x 32	5,400	50	8



Tornillo autotaladrante de cabeza alomada

DIN-7504-N

INOXIDABLE



CÓDIGO	MEDIDA	€/100		ESPESOR MÁX. A FIJAR	CAPACIDAD DE TALADRADO		
ABRA23509	3,5 x 9,5	11,723	PH2	2,85	0,70-2,25	1.000	24.000
ABRA23513	3,5 x 13	14,147	PH2	6,2	0,70-2,25	500	12.000
ABRA23519	3,5 x 19	17,333	PH2	12,1	0,70-2,25	500	12.000
ABRA24213	4,2 x 13	16,567	PH2	4,3	1,75-3,00	500	12.000
ABRA24216	4,2 x 16	18,560	PH2	7,3	1,75-3,00	500	12.000
ABRA24219	4,2 x 19	19,753	PH2	10,3	1,75-3,00	500	12.000
ABRA24225	4,2 x 25	20,747	PH2	16,3	1,75-3,00	250	6.000
ABRA24816	4,8 x 16	25,990	PH2	5,5	1,75-4,40	250	6.000
ABRA24819	4,8 x 19	25,460	PH2	8,7	1,75-4,40	250	6.000
ABRA24825	4,8 x 25	28,290	PH2	14,7	1,75-4,40	250	6.000
ABRA24832	4,8 x 32	33,113	PH2	21,5	1,75-4,40	250	4.000
ABRA24838	4,8 x 38	36,250	PH2	27,5	1,75-4,40	250	3.000
ABRA24850	4,8 x 50	42,743	PH2	39,5	1,75-4,40	250	3.000

DIN-7504-N HP A2

Inoxidable A2. Huella PH

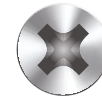

METAL



CÓDIGO	MEDIDA	€/100		ESPESOR MÁX. A FIJAR	CAPACIDAD DE TALADRADO		
NBR3509	3,5 x 9,5	2,820	PH2	2,85	0,70-2,25	1.000	24.000
NBR3513	3,5 x 13	3,507	PH2	6,2	0,70-2,25	1.000	24.000
NBR3516	3,5 x 16	3,597	PH2	9,2	0,70-2,25	1.000	16.000
NBR3519	3,5 x 19	3,970	PH2	12,1	0,70-2,25	1.000	12.000
NBR4213	4,2 x 13	4,150	PH2	4,3	1,75-3,00	1.000	12.000
NBR4216	4,2 x 16	4,593	PH2	7,3	1,75-3,00	1.000	12.000
NBR4219	4,2 x 19	5,160	PH2	10,3	1,75-3,00	1.000	12.000
NBR4225	4,2 x 25	6,367	PH2	16,3	1,75-3,00	500	6.000
NBR4232	4,2 x 32	7,563	PH2	23	1,75-3,00	500	6.000
NBR4238	4,2 x 38	8,877	PH2	29	1,75-3,00	500	6.000
NBR4816	4,8 x 16	6,337	PH2	5,5	1,75-4,40	1.000	8.000
NBR4819	4,8 x 19	7,373	PH2	8,7	1,75-4,40	1.000	8.000
NBR4825	4,8 x 25	8,677	PH2	14,7	1,75-4,40	500	6.000
NBR4832	4,8 x 32	10,533	PH2	21,5	1,75-4,40	500	6.000
NBR4838	4,8 x 38	11,227	PH2	27,5	1,75-4,40	500	3.000
NBR4845	4,8 x 45	13,017	PH2	34,5	1,75-4,40	500	3.000
NBR4850	4,8 x 50	14,117	PH2	39,5	1,75-4,40	500	3.000

DIN-7504-N HP N

Cincado negro. Huella PH



Otras medidas, consultar precio y plazo

METAL



CÓDIGO	MEDIDA	€/100		ESPESOR MÁX. A FIJAR	CAPACIDAD DE TALADRADO		
ABR3509BLE	3,5 x 9,5	2,103	PH2	2,85	0,70-2,25	1.000	24.000
ABR3513BLE	3,5 x 13	5,630	PH2	6,2	0,70-2,25	1.000	24.000
ABR3516BLE	3,5 x 16	6,337	PH2	9,2	0,70-2,25	1.000	16.000
ABR4213BLE	4,2 x 13	7,367	PH2	4,3	1,75-3,00	1.000	12.000
ABR4216BLE	4,2 x 16	8,180	PH2	7,3	1,75-3,00	1.000	12.000
ABR4219BLE	4,2 x 19	8,213	PH2	10,3	1,75-3,00	1.000	12.000
ABR4825BLE	4,8 x 25	11,780	PH2	14,7	1,75-4,40	500	6.000

DIN-7504-N HP B

Pintado blanco. Huella PH



Otras medidas, consultar precio y plazo

DIN-7504-N Tornillo autotaladrante de cabeza redonda

DIN-7504-N HT

Cincado. Huella TX/OXBIT



GRATIS - 1 punta OXBIT en cada caja



CÓDIGO	MEDIDA	€/100	ESPESOR MÁX. A FIJAR	CAPACIDAD DE TALADRADO		
ABRT3509	3,5 x 9,5	2,100	TX15/OXBIT15	2,8	0,70-2,25	1.000 24.000
ABRT3513	3,5 x 13	2,457	TX15/OXBIT15	6,2	0,70-2,25	1.000 24.000
ABRT3516	3,5 x 16	2,627	TX15/OXBIT15	9,2	0,70-2,25	1.000 16.000
ABRT3519	3,5 x 19	2,800	TX15/OXBIT15	12,1	0,70-2,25	1.000 12.000
ABRT3913	3,9 x 13	2,940	TX15/OXBIT15	5,8	0,70-2,40	1.000 16.000
ABRT3916	3,9 x 16	3,163	TX15/OXBIT15	8,8	0,70-2,40	1.000 12.000
ABRT3919	3,9 x 19	3,517	TX15/OXBIT15	11,7	0,70-2,40	1.000 12.000
ABRT3925	3,9 x 25	4,323	TX15/OXBIT15	17,7	0,70-2,40	500 8.000
ABRT4213	4,2 x 13	3,127	TX20/OXBIT20	4,3	1,75-3,00	1.000 12.000
ABRT4216	4,2 x 16	3,423	TX20/OXBIT20	7,3	1,75-3,00	1.000 12.000
ABRT4219	4,2 x 19	3,880	TX20/OXBIT20	10,3	1,75-3,00	1.000 12.000
ABRT4225	4,2 x 25	4,583	TX20/OXBIT20	17,7	1,75-3,00	500 6.000
ABRT4232	4,2 x 32	5,367	TX20/OXBIT20	24,5	1,75-3,00	500 6.000
ABRT4238	4,2 x 38	6,307	TX20/OXBIT20	30,5	1,75-3,00	500 6.000
ABRT4250	4,2 x 50	7,723	TX20/OXBIT20	41	1,75-3,00	500 3.000
ABRT4813	4,8 x 13	4,337	TX25/OXBIT25	3,7	1,75-4,40	1.000 8.000
ABRT4816	4,8 x 16	4,640	TX25/OXBIT25	5,5	1,75-4,40	1.000 8.000
ABRT4819	4,8 x 19	5,120	TX25/OXBIT25	10,3	1,75-4,40	1.000 8.000

METAL



CÓDIGO	MEDIDA	€/100	ESPESOR MÁX. A FIJAR	CAPACIDAD DE TALADRADO		
ABRT4825	4,8 x 25	6,053	TX25/OXBIT25	14,7	1,75-4,40	500 6.000
ABRT4832	4,8 x 32	7,050	TX25/OXBIT25	21,5	1,75-4,40	500 6.000
ABRT4838	4,8 x 38	7,997	TX25/OXBIT25	27,5	1,75-4,40	500 3.000
ABRT4845	4,8 x 45	9,203	TX25/OXBIT25	34,5	1,75-4,40	500 3.000
ABRT4850	4,8 x 50	10,643	TX25/OXBIT25	39,5	1,75-4,40	500 3.000
ABRT4860	4,8 x 60	14,220	TX25/OXBIT25	49,5	1,75-4,40	500 2.000
ABRT4880	4,8 x 80	18,573	TX25/OXBIT25	69,5	1,75-4,40	250 1.500
ABRT4890	4,8 x 90	29,257	TX25/OXBIT25	79,5	1,75-4,40	100 1.200
ABRT4810	4,8 x 100	33,007	TX25/OXBIT25	89,5	1,75-4,40	100 1.200
ABRT4811	4,8 x 110	34,140	TX25/OXBIT25	-	1,75-4,40	100 1.200
ABRT4812	4,8 x 120	35,170	TX25/OXBIT25	-	1,75-4,40	100 1.200
ABRT5519	5,5 x 19	7,187	TX25/OXBIT25	8,7	1,75-5,25	500 6.000
ABRT5525	5,5 x 25	7,913	TX25/OXBIT25	14,7	1,75-5,25	500 4.000
ABRT5532	5,5 x 32	9,600	TX25/OXBIT25	21,5	1,75-5,25	500 3.000
ABRT5538	5,5 x 38	10,787	TX25/OXBIT25	27,5	1,75-5,25	500 3.000
ABRT5560	5,5 x 60	16,927	TX25/OXBIT25	49,5	1,75-5,25	250 1.500
ABRT5573	5,5 x 73	20,413	TX25/OXBIT25	62,5	1,75-5,25	250 1.500

DIN-7504-N HC

Cincado. Huella cuadrada



GRATIS - 1 punta en cada caja

CÓDIGO	MEDIDA	€/100	ESPESOR MÁX. A FIJAR	CAPACIDAD DE TALADRADO		
ABRC3509	3,5 x 9,5	1,827	PC1	2,85	0,70-2,25	1.000 24.000
ABRC3513	3,5 x 13	2,223	PC1	6,2	0,70-2,25	1.000 24.000
ABRC3516	3,5 x 16	2,367	PC1	9,2	0,70-2,25	1.000 16.000
ABRC3519	3,5 x 19	2,537	PC1	12,1	0,70-2,25	1.000 12.000
ABRC3913	3,9 x 13	2,660	PC1	5,8	0,70-2,40	1.000 16.000
ABRC3916	3,9 x 16	2,857	PC1	8,8	0,70-2,40	1.000 12.000
ABRC3919	3,9 x 19	3,177	PC1	11,7	0,70-2,40	1.000 12.000
ABRC3925	3,9 x 25	3,913	PC1	17,7	0,70-2,40	500 8.000
ABRC3938	3,9 x 38	4,327	PC1	30,5	0,70-2,40	500 6.000
ABRC4213	4,2 x 13	2,820	PC2	4,3	1,75-3,00	1.000 12.000
ABRC4216	4,2 x 16	3,093	PC2	7,3	1,75-3,00	1.000 12.000
ABRC4219	4,2 x 19	3,507	PC2	10,3	1,75-3,00	1.000 12.000
ABRC4225	4,2 x 25	4,137	PC2	16,3	1,75-3,00	500 6.000
ABRC4232	4,2 x 32	4,847	PC2	23	1,75-3,00	500 6.000

METAL



CÓDIGO	MEDIDA	€/100	ESPESOR MÁX. A FIJAR	CAPACIDAD DE TALADRADO		
ABRC4238	4,2 x 38	5,693	PC2	29	1,75-3,00	500 6.000
ABRC4816	4,8 x 16	4,363	PC2	5,5	1,75-4,40	1.000 8.000
ABRC4819	4,8 x 19	4,810	PC2	8,7	1,75-4,40	1.000 8.000
ABRC4825	4,8 x 25	5,693	PC2	14,7	1,75-4,40	500 6.000
ABRC4832	4,8 x 32	6,633	PC2	21,5	1,75-4,40	500 6.000
ABRC4838	4,8 x 38	7,523	PC2	27,5	1,75-4,40	500 3.000
ABRC4845	4,8 x 45	8,750	PC2	34,5	1,75-4,40	500 3.000
ABRC4850	4,8 x 50	10,013	PC2	39,5	1,75-4,40	500 3.000
ABRC4860	4,8 x 60	13,377	PC2	49,5	1,75-4,40	500 2.000
ABRC4880	4,8 x 80	17,473	PC2	69,5	1,75-4,40	250 1.500
ABRC4890	4,8 x 90	27,520	PC2	79,5	1,75-4,40	100 1.200
ABRC4810	4,8 x 100	31,053	PC2	89,5	1,75-4,40	100 1.200
ABRC5525	5,5 x 25	6,770	PC3	13	1,75-5,25	500 4.000
ABRC5573	5,5 x 73	17,453	PC3	61	1,75-5,25	250 1.500

• Hasta fin de existencias

TORNILLERÍA LACADA EN COLORES

AMPLIAR INFORMACIÓN EN PÁGINA 160



SOLO CABEZA



**TORNILLO
COMPLETO**



Tornillo autotaladrante con cabeza avellanada

DIN-7504-P

METAL



Chapa

Chapa - per-
fil pesado

Z
ZINC

DIN-7504-P HP Z

Cincado. Huella PH

CÓDIGO	MEDIDA	€/100		ESPESOR MÁX. A FIJAR	CAPACIDAD DE TALADRADO		
ABP3509	3,5 x 9,5	2,447	PH2	2,85	0,70-2,25	1.000	24.000
ABP3511	3,5 x 11	1,947	PH2	4,2	0,70-2,25	1.000	24.000
ABP3513	3,5 x 13	1,973	PH2	6,2	0,70-2,25	1.000	24.000
ABP3516	3,5 x 16	2,173	PH2	9,2	0,70-2,25	1.000	24.000
ABP3519	3,5 x 19	2,587	PH2	12,1	0,70-2,25	1.000	12.000
ABP3522	3,5 x 22	2,940	PH2	15,1	0,70-2,25	1.000	12.000
ABP3525	3,5 x 25	2,933	PH2	18,1	0,70-2,25	500	12.000
ABP3913	3,9 x 13	2,263	PH2	5,8	0,70-2,40	1.000	24.000
ABP3916	3,9 x 16	2,517	PH2	8,8	0,70-2,40	1.000	12.000
ABP3919	3,9 x 19	2,853	PH2	11,7	0,70-2,40	1.000	12.000
ABP3922	3,9 x 22	3,203	PH2	14,7	0,70-2,40	500	12.000
ABP3925	3,9 x 25	3,217	PH2	17,7	0,70-2,40	500	12.000
ABP3932	3,9 x 32	3,870	PH2	24,5	0,70-2,40	500	6.000
ABP3938	3,9 x 38	4,610	PH2	30,5	0,70-2,40	500	6.000
ABP4213	4,2 x 13	2,590	PH2	4,3	1,75-3,00	1.000	12.000
ABP4216	4,2 x 16	2,853	PH2	7,3	1,75-3,00	1.000	12.000
ABP4219	4,2 x 19	3,150	PH2	10,3	1,75-3,00	1.000	12.000
ABP4222	4,2 x 22	3,480	PH2	13,3	1,75-3,00	500	12.000
ABP4225	4,2 x 25	3,870	PH2	16,3	1,75-3,00	500	6.000
ABP4232	4,2 x 32	4,543	PH2	23	1,75-3,00	500	6.000
ABP4238	4,2 x 38	5,310	PH2	29	1,75-3,00	500	6.000
ABP4813	4,8 x 13	3,563	PH2	3,7	1,75-4,40	1.000	12.000
ABP4816	4,8 x 16	3,790	PH2	5,5	1,75-4,40	1.000	12.000
ABP4819	4,8 x 19	4,077	PH2	8,7	1,75-4,40	1.000	8.000
ABP4825	4,8 x 25	4,640	PH2	14,7	1,75-4,40	500	6.000
ABP4832	4,8 x 32	6,013	PH2	21,5	1,75-4,40	500	6.000
ABP4838	4,8 x 38	6,943	PH2	27,5	1,75-4,40	500	3.000
ABP4850	4,8 x 50	8,713	PH2	39,5	1,75-4,40	500	3.000
ABP5519	5,5 x 19	5,793	PH3	8,7	1,75-5,25	500	6.000
ABP5525	5,5 x 25	6,620	PH3	14,7	1,75-5,25	500	6.000
ABP5532	5,5 x 32	8,347	PH3	21,5	1,75-5,25	500	3.000
ABP5538	5,5 x 38	9,253	PH3	27,5	1,75-5,25	500	3.000
ABP5550	5,5 x 50	11,900	PH3	39,5	1,75-5,25	500	3.000



Blister



Caja con Ventana

CÓDIGO	MEDIDA	€/BOLSA	PCS. 	BOLSAS
BZABP3513	3,5 x 13	2,565	40	20
BZABP3516	3,5 x 16	2,565	40	20
BZABP4219	4,2 x 19	2,565	40	20
BZABP4225	4,2 x 25	2,565	20	20
BZABP4232	4,2 x 32	2,565	20	20

CÓDIGO	MEDIDA	€/CAJA	PCS. 	CAJAS
VABP3513	3,5 x 13	6,183	250	8
VABP3516	3,5 x 16	6,148	225	8
VABP3519	3,5 x 19	6,423	200	8
VABP3525	3,5 x 25	6,637	180	8
VABP3913	3,9 x 13	5,705	200	8
VABP3916	3,9 x 16	6,416	200	8
VABP3919	3,9 x 19	6,219	175	8
VABP3925	3,9 x 25	6,215	150	8
VABP3938	3,9 x 38	5,844	100	8
VABP4213	4,2 x 13	5,834	175	8
VABP4216	4,2 x 16	6,219	175	8
VABP4219	4,2 x 19	6,732	175	8
VABP4225	4,2 x 25	6,066	125	8
VABP4232	4,2 x 32	5,117	90	8
VABP4238	4,2 x 38	4,986	75	8
VABP4816	4,8 x 16	6,112	125	8
VABP4819	4,8 x 19	5,374	100	8
VABP4825	4,8 x 25	5,156	90	8
VABP4832	4,8 x 32	5,726	75	8
VABP4838	4,8 x 38	6,671	75	8
VABP5532	5,5 x 32	5,147	50	8

METAL



Chapa

Chapa - per-
fil pesado

BLACK

DIN-7504-P HP N

Cincado negro. Huella PH

CÓDIGO	MEDIDA	€/100		ESPESOR MÁX. A FIJAR	CAPACIDAD DE TALADRADO		
NBP3513	3,5 x 13	3,100	PH2	6,2	0,70-2,25	1.000	24.000
NBP3516	3,5 x 16	3,383	PH2	9,2	0,70-2,25	1.000	24.000
NBP3519	3,5 x 19	3,823	PH2	12,1	0,70-2,25	1.000	12.000
NBP3525	3,5 x 25	4,840	PH2	18,1	0,70-2,25	500	12.000
NBP4216	4,2 x 16	4,213	PH2	7,3	1,75-3,00	1.000	12.000
NBP4219	4,2 x 19	5,140	PH2	10,3	1,75-3,00	1.000	12.000
NBP4225	4,2 x 25	5,837	PH2	16,3	1,75-3,00	500	6.000
NBP4232	4,2 x 32	6,817	PH2	23	1,75-3,00	500	6.000
NBP4238	4,2 x 38	9,117	PH2	29	1,75-3,00	500	6.000
NBP4825	4,8 x 25	8,483	PH2	14,7	1,75-4,40	500	6.000
NBP4832	4,8 x 32	10,233	PH2	21,5	1,75-4,40	500	6.000
NBP4838	4,8 x 38	11,783	PH2	27,5	1,75-4,40	500	3.000
NBP4850	4,8 x 50	13,883	PH2	39,5	1,75-4,40	500	3.000



DIN-7504-P Tornillo autotaladrante con cabeza avellanada

DIN-7504-P HT Z

Cincado. Huella TX/OXBIT



GRATIS - 1 punta OXBIT en cada caja



CÓDIGO	MEDIDA	€/100		ESPESOR MÁX. A FIJAR	CAPACIDAD DE TALADRADO		
ABPT3513	3,5 x 13	2,287	TX15/OXBIT15	6,2	0,70-2,25	1.000	24.000
ABPT3516	3,5 x 16	2,527	TX15/OXBIT15	9,2	0,70-2,25	1.000	24.000
ABPT3519	3,5 x 19	3,000	TX15/OXBIT15	12,1	0,70-2,25	1.000	12.000
ABPT3913	3,9 x 13	2,637	TX15/OXBIT15	5,8	0,70-2,40	1.000	24.000
ABPT3916	3,9 x 16	2,923	TX15/OXBIT15	8,8	0,70-2,40	1.000	12.000
ABPT4213	4,2 x 13	2,960	TX20/OXBIT20	4,3	1,75-3,00	1.000	12.000
ABPT4216	4,2 x 16	3,320	TX20/OXBIT20	7,3	1,75-3,00	1.000	12.000
ABPT4219	4,2 x 19	3,597	TX20/OXBIT20	10,3	1,75-3,00	1.000	12.000
ABPT4225	4,2 x 25	4,493	TX20/OXBIT20	16,3	1,75-3,00	500	6.000
ABPT4232	4,2 x 32	5,193	TX20/OXBIT20	23	1,75-3,00	500	6.000
ABPT4819	4,8 x 19	4,657	TX25/OXBIT25	8,7	1,75-4,40	1.000	8.000
ABPT4825	4,8 x 25	5,293	TX25/OXBIT25	14,7	1,75-4,40	500	6.000
ABPT4832	4,8 x 32	6,987	TX25/OXBIT25	21,5	1,75-4,40	500	6.000
ABPT4838	4,8 x 38	8,070	TX25/OXBIT25	27,5	1,75-4,40	500	3.000
ABPT4850	4,8 x 50	10,127	TX25/OXBIT25	39,5	1,75-4,40	500	3.000

ABA

Tornillo autotaladrante con broca de dos alas, cabeza avellanada

ABA

Cincado. Huella PH

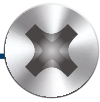

Disponible en varios recubrimientos. Consulte precio y plazo de entrega.



CÓDIGO	MEDIDA	€/100		ESPESOR MÁX. A FIJAR	CAPACIDAD DE TALADRADO		
ABA4832	4,8 x 32	5,573	PH2	16	1,75 - 4,00	500	6.000
ABA4838	4,8 x 38	6,287	PH2	22	1,75 - 4,00	500	6.000
ABA4845	4,8 x 45	7,247	PH2	29	1,75 - 4,00	500	3.000
ABA4850	4,8 x 50	8,460	PH2	34	1,75 - 4,00	500	3.000
ABA5538	5,5 x 38	9,627	PH2	19	1,75 - 5,00	500	3.000
ABA5545	5,5 x 45	9,793	PH2	26	1,75 - 5,00	500	3.000
ABA5555	5,5 x 55	11,693	PH2	36	1,75 - 5,00	500	3.000
ABA5565	5,5 x 65	14,197	PH2	46	1,75 - 5,00	500	2.000
ABA6360	6,3 x 60	18,540	PH2	40	2,50 - 6,00	250	1.500
ABA6370	6,3 x 70	21,100	PH2	50	2,50 - 6,00	250	1.500
ABA6385	6,3 x 85	25,327	PH2	65	2,50 - 6,00	250	1.000

ATA

Cincado. Huella TX



Disponible en varios recubrimientos. Consulte precio y plazo de entrega.



CÓDIGO	MEDIDA	€/100		ESPESOR MÁX. A FIJAR	CAPACIDAD DE TALADRADO		
ATA4832	4,8 x 32	5,850	TX25	16	1,75 - 4,00	500	6.000
ATA4838	4,8 x 38	6,597	TX25	22	1,75 - 4,00	500	6.000
ATA4845	4,8 x 45	7,603	TX25	29	1,75 - 4,00	500	3.000
ATA4850	4,8 x 50	8,877	TX25	34	1,75 - 4,00	500	3.000
ATA5538	5,5 x 38	10,100	TX25	19	1,75 - 5,00	500	3.000
ATA5545	5,5 x 45	10,283	TX25	26	1,75 - 5,00	500	3.000
ATA5550	5,5 x 50	11,987	TX25	31	1,75 - 5,00	500	3.000
ATA5555	5,5 x 55	12,270	TX25	36	1,75 - 5,00	500	2.000
ATA5565	5,5 x 65	14,903	TX25	46	1,75 - 5,00	500	2.000
ATA6350	6,3 x 50	17,513	TX30	30	2,50 - 6,00	500	2.000
ATA6360	6,3 x 60	19,460	TX30	40	2,50 - 6,00	250	1.500
ATA6370	6,3 x 70	22,150	TX30	50	2,50 - 6,00	250	1.500
ATA6385	6,3 x 85	26,587	TX30	65	2,50 - 6,00	250	1.000
ATA6310	6,3 x 100	38,307	TX30	80	2,50 - 6,00	250	750

RS

Tornillo punta broca, cabeza remache y huella PH

RS

Cincado



PATENTADO



Disponible en varios recubrimientos. Consulte precio y plazo de entrega.



CÓDIGO	MEDIDA	€/100		ESPESOR MÁX. A FIJAR	CAPACIDAD DE TALADRADO		
RSZ3509	3,5 x 9	3,990	PH2	2,8	0,75 - 2,25	500	22.500
RSZ3513	3,5 x 13	4,367	PH2	6,2	0,75 - 2,25	500	22.500
RSZ3516	3,5 x 16	4,827	PH2	9,2	0,75 - 2,25	500	22.500
RSZ4213	4,2 x 13	5,597	PH2	4,3	1,75 - 3	500	22.500
RSZ4216	4,2 x 16	5,830	PH2	7,3	1,75 - 3	500	12.000
RSZ4219	4,2 x 19	6,713	PH2	10,3	1,75 - 3	500	12.000
RSZ4225	4,2 x 25	8,723	PH2	16,3	1,75 - 3	250	6.000
RSZ4232	4,2 x 32	9,120	PH2	23	1,75 - 3	250	6.000
RSZ4813	4,8 x 13	8,383	PH2	3,7	1,75 - 4,4	500	12.000
RSZ4816	4,8 x 16	8,627	PH2	5,5	1,75 - 4,4	250	11.250
RSZ4819	4,8 x 19	9,780	PH2	8,7	1,75 - 4,4	250	11.250
RSZ4825	4,8 x 25	11,873	PH2	14,7	1,75 - 4,4	250	6.000
RSZ4832	4,8 x 32	12,660	PH2	21,5	1,75 - 4,4	250	3.000
RSZ4838	4,8 x 38	14,413	PH2	27,5	1,75 - 4,4	250	3.000



Tornillo punta broca, cabeza remache y huella PH

RS

INOXIDABLE



CÓDIGO	MEDIDA	€/100	HUELLA	ESPESOR MÁX. A FIJAR		
RSA23509	3,5 x 9,5	17,757	PH2	2,8	500	22.500
RSA24213	4,2 x 13	25,577	PH2	4,3	500	22.500
RSA24216	4,2 x 16	27,243	PH2	7,3	500	12.000
RSA24219	4,2 x 19	28,893	PH2	10,3	500	12.000
RSA24816	4,8 x 16	35,750	PH2	5,5	250	11.250
RSA24819	4,8 x 19	38,310	PH2	8,7	250	11.250
RSA24825	4,8 x 25	43,217	PH2	14,7	250	6.000

RS-A2 **NEW**

Inoxidable A2



PATENTADO

Tornillo autotaladrante de cabeza extraplana y huella PH

BCP

METAL



CÓDIGO	MEDIDA	€/100		ESPESOR MÁX. A FIJAR	CAPACIDAD DE TALADRADO		
BCPZ4214	4,2 x 14	2,637	PH2	6	0,70-2,00	500	12.000
BCPZ4223	4,2 x 23	3,900	PH2	15	0,70-2,00	500	12.000

BCP Z

Cincado. Huella PH



Disponibles en varios recubrimientos. Consulte precio y plazo de entrega.

INOXIDABLE



CÓDIGO	MEDIDA	€/100		ESPESOR MÁX. A FIJAR	CAPACIDAD DE TALADRADO		
BCPA24214	4,2 x 14	24,470	PH2	6	0,70-2,00	500	12.000
BCPA24223 NEW	4,2 x 23	33,773	PH2	6	-	500	12.000

BCP A2

Inoxidable A2. Huella PH



METAL



CÓDIGO	MEDIDA	€/100		ESPESOR MÁX. A FIJAR	CAPACIDAD DE TALADRADO		
BCPN4214	4,2 x 14	3,970	PH2	6	0,70-2,00	500	12.000
BCPN4223	4,2 x 23	5,870	PH2	15	0,70-2,00	500	12.000

BCP N

Cincado negro. Huella PH



METAL



CÓDIGO	MEDIDA	€/100		ESPESOR MÁX. A FIJAR	CAPACIDAD DE TALADRADO		
BCPB4214	4,2 x 14	6,050	PH2	6	0,70-2,00	500	12.000
BCPB4223	4,2 x 23	9,117	PH2	15	0,70-2,00	500	12.000

BCP B

Pintado blanco. Huella PH



METAL



CÓDIGO	MEDIDA	€/100		ESPESOR MÁX. A FIJAR	CAPACIDAD DE TALADRADO		
BCPZ4214BL	4,2 x 14	10,803	PH2	6	0,70-2,00	500	22.500
BCPZ4223BL	4,2 x 23	13,557	PH2	15	0,70-2,00	500	12.000

BCP CB

Cabeza lacada blanca. Huella PH



TAE

Tornillo autotaladrante de cabeza alomada baja y arandela estampada

TAEZ

Cincado. Huella PH



Disponible en varios recubrimientos. Consulte precio y plazo de entrega.

CÓDIGO	MEDIDA	€/100	ESPECIAL	ESPELOR MÁX. A FIJAR	CAPACIDAD DE TALADRADO	CAJA	BLISTER
TAEZ4213	4,2 x 13	4,640	PH2	4,3	0,75 - 2,50	500	12.000
TAEZ4216	4,2 x 16	5,123	PH2	7,3	0,75 - 2,50	500	8.000
TAEZ4219	4,2 x 19	5,713	PH2	10,3	0,75 - 2,50	500	6.000
TAEZ4225	4,2 x 25	5,847	PH2	16,3	0,75 - 2,50	500	6.000
TAEZ4232	4,2 x 32	6,710	PH2	23	0,75 - 2,50	500	6.000



TAEN

Cincado negro. Huella PH



CÓDIGO	MEDIDA	€/100	ESPECIAL	ESPELOR MÁX. A FIJAR	CAPACIDAD DE TALADRADO	CAJA	BLISTER
TAEN4213	4,2 x 13	7,977	PH2	4,3	0,75 - 2,50	500	12.000
TAEN4216	4,2 x 16	8,523	PH2	7,3	0,75 - 2,50	500	8.000
TAEN4219	4,2 x 19	10,397	PH2	10,3	0,75 - 2,50	500	6.000
TAEN4225	4,2 x 25	12,373	PH2	16,3	0,75 - 2,50	500	6.000
TAEN4232	4,2 x 32	14,140	PH2	23	0,75 - 2,50	500	6.000



DIN-7981 HP

Tornillo rosca chapa con cabeza alomada

DIN-7981 HP Z

Cincado. Huella PH



P.160
Disponible en diferentes colores



Disponible en varios recubrimientos. Consulte precio y plazo de entrega.

CÓDIGO	MEDIDA	€/100	ESPECIAL	CAJA	BLISTER	CÓDIGO	MEDIDA	€/100	ESPECIAL	CAJA	BLISTER
T8129006	2,9 x 6,5	1,529	PH1	1.000	45.000	T8148025	4,8 x 25	5,510	PH2	250	6.000
T8129009	2,9 x 9,5	1,583	PH1	1.000	30.000	T8148032	4,8 x 32	6,182	PH2	250	4.000
T8129013	2,9 x 13	1,598	PH1	1.000	24.000	T8148038	4,8 x 38	7,247	PH2	250	3.000
T8129016	2,9 x 16	1,787	PH1	1.000	24.000	T8148045	4,8 x 45	8,210	PH2	250	3.000
T8129019	2,9 x 19	1,937	PH1	1.000	24.000	T8148050	4,8 x 50	8,933	PH2	250	3.000
T8129022	2,9 x 22	2,216	PH1	1.000	12.000	T8148060	4,8 x 60	11,253	PH2	250	1.500
T8129025	2,9 x 25	2,497	PH1	500	12.000	T8148070	4,8 x 70	13,377	PH2	100	1.200
T8135006	3,5 x 6,5	1,597	PH2	1.000	24.000	T8148080	4,8 x 80	16,423	PH2	100	1.200
T8135009	3,5 x 9,5	1,635	PH2	1.000	24.000	T8148090	4,8 x 90	19,027	PH2	100	1.200
T8135013	3,5 x 13	1,950	PH2	500	15.000	T8148100	4,8 x 100	20,700	PH2	100	1.200
T8135016	3,5 x 16	2,262	PH2	500	12.000	T8148110	4,8 x 110	25,973	PH2	100	1.200
T8135019	3,5 x 19	2,460	PH2	500	12.000	T8148120	4,8 x 120	30,667	PH2	100	1.200
T8135025	3,5 x 25	3,163	PH2	250	6.000	T8155013	5,5 x 13	5,383	PH3	250	6.000
T8135032	3,5 x 32	3,770	PH2	250	6.000	T8155016	5,5 x 16	5,758	PH3	250	6.000
T8139009	3,9 x 9,5	1,967	PH2	500	15.000	T8155019	5,5 x 19	6,023	PH3	250	6.000
T8139013	3,9 x 13	2,382	PH2	500	12.000	T8155022	5,5 x 22	6,980	PH3	250	4.000
T8139016	3,9 x 16	2,590	PH2	500	12.000	T8155025	5,5 x 25	7,197	PH3	250	4.000
T8139019	3,9 x 19	2,963	PH2	500	12.000	T8155032	5,5 x 32	8,427	PH3	250	3.000
T8139022	3,9 x 22	3,300	PH2	250	6.000	T8155038	5,5 x 38	9,413	PH3	250	3.000
T8139025	3,9 x 25	3,655	PH2	250	6.000	T8155045	5,5 x 45	10,777	PH3	250	3.000
T8139032	3,9 x 32	4,130	PH2	250	6.000	T8155050	5,5 x 50	11,777	PH3	250	1.500
T8139038	3,9 x 38	4,833	PH2	250	6.000	T8155060	5,5 x 60	14,630	PH3	100	1.200
T8139045	3,9 x 45	5,823	PH2	250	3.000	T8155070	5,5 x 70	16,243	PH3	100	1.200
T8139050	3,9 x 50	6,463	PH2	250	3.000	T8155080	5,5 x 80	20,250	PH3	100	1.200
T8142009	4,2 x 9,5	2,470	PH2	500	12.000	T8155090	5,5 x 90	23,277	PH3	100	1.200
T8142013	4,2 x 13	2,663	PH2	500	12.000	T8155100	5,5 x 100	27,200	PH3	100	1.200
T8142016	4,2 x 16	3,201	PH2	500	12.000	T8155110	5,5 x 110	32,947	PH3	100	1.200
T8142019	4,2 x 19	3,237	PH2	500	8.000	T8155120	5,5 x 120	39,368	PH3	100	1.200
T8142022	4,2 x 22	4,019	PH2	250	6.000	T8163016	6,3 x 16	7,676	PH3	250	4.000
T8142025	4,2 x 25	4,037	PH2	250	6.000	T8163019	6,3 x 19	8,180	PH3	250	3.000
T8142032	4,2 x 32	4,723	PH2	250	6.000	T8163022	6,3 x 22	8,770	PH3	250	3.000
T8142038	4,2 x 38	5,527	PH2	250	3.000	T8163025	6,3 x 25	9,350	PH3	250	3.000
T8142045	4,2 x 45	6,327	PH2	250	3.000	T8163032	6,3 x 32	11,703	PH3	250	3.000
T8142050	4,2 x 50	6,687	PH2	250	3.000	T8163038	6,3 x 38	13,233	PH3	250	1.500
T8142060	4,2 x 60	9,017	PH2	250	3.000	T8163045	6,3 x 45	15,487	PH3	250	1.500
T8142070	4,2 x 70	10,127	PH2	250	1.500	T8163050	6,3 x 50	16,913	PH3	250	1.500
T8142080	4,2 x 80	12,057	PH2	250	1.500	T8163060	6,3 x 60	19,537	PH3	100	1.200
T8142090	4,2 x 90	16,388	PH2	250	1.500	T8163070	6,3 x 70	22,223	PH3	100	1.200
T8148009	4,8 x 9,5	3,520	PH2	500	12.000	T8163080	6,3 x 80	27,490	PH3	100	1.200
T8148013	4,8 x 13	3,591	PH2	500	8.000	T8163090	6,3 x 90	35,213	PH3	50	600
T8148016	4,8 x 16	4,021	PH2	250	6.000	T8163100	6,3 x 100	40,727	PH3	50	600
T8148019	4,8 x 19	4,800	PH2	250	6.000	T8163110	6,3 x 110	44,670	PH3	50	600
T8148022	4,8 x 22	5,245	PH2	250	6.000	T8163120	6,3 x 120	47,923	PH3	50	600



BLISTER y CAJA VENTANA
Siguiente página



Tornillo rosca chapa con cabeza alomada

DIN-7981 HP



Blister

CÓDIGO	MEDIDA	€/BOLSA	PCS. B	BOLSAS B
BZT8135009	3,5 x 9,5	2,029	40	20
BZT8135013	3,5 x 13	2,029	20	20
BZT8135016	3,5 x 16	2,029	20	20
BZT8135019	3,5 x 19	2,029	20	20
BZT8139013	3,9 x 13	2,029	20	20
BZT8139016	3,9 x 16	2,029	20	20
BZT8139019	3,9 x 19	2,029	20	20
BZT8139025	3,9 x 25	2,029	10	20
BZT8139032	3,9 x 32	2,029	10	20
BZT8142009	4,2 x 9,5	2,029	20	20
BZT8142013	4,2 x 13	2,029	20	20
BZT8142016	4,2 x 16	2,029	20	20
BZT8142019	4,2 x 19	2,029	20	20
BZT8142025	4,2 x 25	2,029	10	20
BZT8142032	4,2 x 32	2,029	10	20
BZT8142038	4,2 x 38	2,029	10	20
BZT8148016	4,8 x 16	2,029	10	20
BZT8148019	4,8 x 19	2,029	10	20
BZT8148025	4,8 x 25	2,029	10	20
BZT8148032	4,8 x 32	2,029	10	20
BZT8148038	4,8 x 38	2,029	10	20
BZT8148050	4,8 x 50	2,029	10	20
BZT8148060	4,8 x 60	2,029	10	20
BZT8155025	5,5 x 25	2,029	10	20
BZT8155032	5,5 x 32	2,029	10	20
BZT8155038	5,5 x 38	2,029	10	20
BZT8155050	5,5 x 50	2,029	10	20



Caja con Ventana

CÓDIGO	MEDIDA	€/CAJA	PCS. B	CAJAS B
VT8135009	3,5 x 9,5	5,842	250	8
VT8135013	3,5 x 13	5,738	200	8
VT8135016	3,5 x 16	6,324	200	8
VT8135019	3,5 x 19	6,884	200	8
VT8135025	3,5 x 25	9,144	200	8
VT8139009	3,9 x 9,5	6,062	200	8
VT8139013	3,9 x 13	6,777	200	8
VT8139016	3,9 x 16	7,458	200	8
VT8139019	3,9 x 19	6,549	150	8
VT8139022	3,9 x 22	5,200	100	8
VT8139025	3,9 x 25	5,445	100	8
VT8142009	4,2 x 9,5	7,301	200	8
VT8142013	4,2 x 13	7,426	200	8
VT8142016	4,2 x 16	8,853	200	8
VT8142019	4,2 x 19	7,031	150	8
VT8142022	4,2 x 22	5,817	100	8
VT8142025	4,2 x 25	5,624	100	8
VT8142032	4,2 x 32	6,635	100	8
VT8142038	4,2 x 38	5,861	75	8
VT8142050	4,2 x 50	5,144	50	8
VT8148009	4,8 x 9,5	7,152	150	8
VT8148013	4,8 x 13	7,449	150	8
VT8148016	4,8 x 16	5,597	100	8
VT8148019	4,8 x 19	6,362	100	8
VT8148025	4,8 x 25	7,559	100	8
VT8148032	4,8 x 32	8,297	100	8
VT8148038	4,8 x 38	10,487	100	8
VT8148045	4,8 x 45	8,441	70	8
VT8148050	4,8 x 50	6,463	50	8
VT8148060	4,8 x 60	8,138	50	8
VT8148070	4,8 x 70	7,746	40	8
VT8148080	4,8 x 80	6,192	25	8
VT8155019	5,5 x 19	8,594	100	8
VT8155025	5,5 x 25	9,222	90	8
VT8155032	5,5 x 32	11,836	100	8
VT8155038	5,5 x 38	10,133	75	8

DIN-7981 HP Z

Cincado. Huella PH



P160

Disponible en diferentes colores



Disponible en varios recubrimientos. Consulte precio y plazo de entrega.



CAJA PROFESIONAL
Página anterior



CÓDIGO	MEDIDA	€/100	PH2	1.000	24.000
T813509BLE	3,5 x 9,5	4,480	PH2	1.000	24.000
T814213BLE	4,2 x 13	7,123	PH2	500	12.000
T814225BLE	4,2 x 25	11,160	PH2	250	6.000

DIN-7981 HP B

Pintado blanco. Huella PH



CÓDIGO	MEDIDA	€/100	PH1	1.000	30.000
TZN812909	2,9 x 9,5	2,307	PH1	1.000	30.000
TZN813513	3,5 x 13	3,047	PH2	500	15.000
TZN813516	3,5 x 16	3,727	PH2	500	12.000
TZN813519	3,5 x 19	4,230	PH2	500	12.000
TZN813525	3,5 x 25	5,753	PH2	250	6.000
TZN814216	4,2 x 16	4,870	PH2	500	12.000
TZN814219	4,2 x 19	5,273	PH2	500	8.000
TZN814225	4,2 x 25	6,023	PH2	250	6.000
TZN814232	4,2 x 32	8,307	PH2	250	6.000
TZN814238	4,2 x 38	9,407	PH2	250	3.000
TZN814816	4,8 x 16	6,787	PH2	250	6.000
TZN814819	4,8 x 19	7,483	PH2	250	6.000
TZN814822	4,8 x 22	7,957	PH2	250	6.000
TZN814825	4,8 x 25	7,893	PH2	250	6.000
TZN814838	4,8 x 38	11,613	PH2	250	3.000
TZN814850	4,8 x 50	16,537	PH2	250	3.000

DIN-7981 HP N

Cincado negro. Huella PH



DIN-7982 HP Tornillo rosca chapa con cabeza avellanada

DIN-7982 HP Z

Cincado. Huella PH



P160
Disponible en diferentes colores

Disponible en varios recubrimientos. Consulte precio y plazo de entrega.



CÓDIGO	MEDIDA	€/100			
T8229006	2,9 x 6,5	1,576	PH1	1.000	45.000
T8229009	2,9 x 9,5	1,450	PH1	1.000	45.000
T8229013	2,9 x 13	1,463	PH1	1.000	45.000
T8229016	2,9 x 16	1,510	PH1	1.000	24.000
T8229019	2,9 x 19	1,833	PH1	1.000	24.000
T8229022	2,9 x 22	1,853	PH1	1.000	24.000
T8229025	2,9 x 25	2,317	PH1	500	12.000
T8235009	3,5 x 9,5	1,623	PH2	1.000	24.000
T8235013	3,5 x 13	1,820	PH2	500	22.500
T8235016	3,5 x 16	2,046	PH2	500	22.500
T8235019	3,5 x 19	2,263	PH2	500	12.000
T8235022	3,5 x 22	2,517	PH2	500	12.000
T8235025	3,5 x 25	3,083	PH2	250	11.250
T8235032	3,5 x 32	3,670	PH2	250	6.000
T8235038	3,5 x 38	4,157	PH2	250	6.000
T8239009	3,9 x 9,5	1,950	PH2	500	22.500
T8239013	3,9 x 13	2,128	PH2	500	12.000
T8239016	3,9 x 16	2,413	PH2	500	12.000
T8239019	3,9 x 19	2,663	PH2	500	12.000
T8239022	3,9 x 22	3,310	PH2	250	6.000
T8239025	3,9 x 25	3,603	PH2	250	6.000
T8239032	3,9 x 32	4,367	PH2	250	6.000
T8239038	3,9 x 38	4,773	PH2	250	6.000
T8239045	3,9 x 45	5,427	PH2	250	3.000
T8239050	3,9 x 50	6,367	PH2	250	3.000
T8242013	4,2 x 13	2,337	PH2	500	15.000
T8242016	4,2 x 16	2,593	PH2	500	12.000
T8242019	4,2 x 19	3,163	PH2	500	12.000
T8242022	4,2 x 22	3,653	PH2	250	11.250
T8242025	4,2 x 25	3,931	PH2	250	6.000
T8242032	4,2 x 32	4,613	PH2	250	6.000
T8242038	4,2 x 38	5,443	PH2	250	6.000
T8242045	4,2 x 45	6,291	PH2	250	3.000

Blister

CÓDIGO	MEDIDA	€/BOLSA	PCS.	BOLSAS
BZT8242019	4,2 x 19	2,029	20	20
BZT8242025	4,2 x 25	2,029	10	20
BZT8248025	4,8 x 25	2,029	10	20
BZT8248038	4,8 x 38	2,029	10	20

CÓDIGO	MEDIDA	€/100			
T8242050	4,2 x 50	7,033	PH2	250	3.000
T8242060	4,2 x 60	8,720	PH2	250	3.000
T8242070	4,2 x 70	10,333	PH2	250	3.000
T8248013	4,8 x 13	3,137	PH2	500	12.000
T8248016	4,8 x 16	3,738	PH2	250	11.250
T8248019	4,8 x 19	4,465	PH2	250	6.000
T8248022	4,8 x 22	4,713	PH2	250	6.000
T8248025	4,8 x 25	5,347	PH2	250	6.000
T8248032	4,8 x 32	5,970	PH2	250	6.000
T8248038	4,8 x 38	7,183	PH2	250	3.000
T8248045	4,8 x 45	8,110	PH2	250	3.000
T8248050	4,8 x 50	9,690	PH2	250	3.000
T8248060	4,8 x 60	11,033	PH2	250	1.500
T8248070	4,8 x 70	13,743	PH2	100	2.400
T8255013	5,5 x 13	4,403	PH3	250	7.500
T8255016	5,5 x 16	4,937	PH3	250	6.000
T8255019	5,5 x 19	5,670	PH3	250	6.000
T8255022	5,5 x 22	6,603	PH3	250	6.000
T8255025	5,5 x 25	6,970	PH3	250	6.000
T8255032	5,5 x 32	8,053	PH3	250	3.000
T8255038	5,5 x 38	9,150	PH3	250	3.000
T8255045	5,5 x 45	10,677	PH3	250	3.000
T8255050	5,5 x 50	13,347	PH3	250	1.500
T8255060	5,5 x 60	15,183	PH3	100	1.200
T8255070	5,5 x 70	17,077	PH3	100	1.200
T8263025	6,3 x 25	9,920	PH3	250	3.000
T8263032	6,3 x 32	12,283	PH3	250	3.000
T8263038	6,3 x 38	12,683	PH3	250	3.000
T8263045	6,3 x 45	12,903	PH3	250	1.500
T8263050	6,3 x 50	15,473	PH3	250	1.500
T8263060	6,3 x 60	21,610	PH3	100	1.200
T8263070	6,3 x 70	22,600	PH3	100	1.200

Caja con Ventana

CÓDIGO	MEDIDA	€/CAJA	PCS.	CAJAS
VT8235009	3,5 x 9,5	5,756	250	8
VT8235013	3,5 x 13	5,005	200	8
VT8235016	3,5 x 16	5,497	200	8
VT8235019	3,5 x 19	6,090	200	8
VT8235025	3,5 x 25	4,133	100	8
VT8239016	3,9 x 16	6,452	200	8
VT8239019	3,9 x 19	7,079	200	8
VT8239022	3,9 x 22	4,912	100	8
VT8239025	3,9 x 25	5,237	100	8
VT8242016	4,2 x 16	6,939	200	8
VT8242019	4,2 x 19	7,743	200	8
VT8242025	4,2 x 25	5,182	100	8
VT8242032	4,2 x 32	6,009	100	8
VT8248019	4,8 x 19	5,646	100	8
VT8248025	4,8 x 25	7,063	100	8
VT8248032	4,8 x 32	7,301	95	8
VT8248038	4,8 x 38	7,531	80	8
VT8255032	5,5 x 32	8,229	75	8
VT8255038	5,5 x 38	8,557	70	8



Tornillo rosca chapa con cabeza extraplana

CP

METAL



CÓDIGO	MEDIDA	€/100		ESPEJOR MÁX. A FIJAR		
TCPZ4213	4,2 x 13	2,433	PH2	6	500	12.000
TCPZ4222	4,2 x 22	3,497	PH2	15	500	12.000
TCPZ4232	4,2 x 32	4,660	PH2	25	500	6.000

CP-Z

Cincado. Huella PH



Disponible en varios recubrimientos. Consulte precio y plazo de entrega.

INOXIDABLE



CÓDIGO	MEDIDA	€/100		ESPEJOR MÁX. A FIJAR		
TCPA24213	4,2 x 13	8,980	PH2	6	500	12.000
TCPA24222	4,2 x 22	17,420	PH2	15	500	12.000
TCPA24232	4,2 x 32	22,313	PH2	25	500	6.000

CP-A2

Inoxidable A2. Huella PH



METAL



CÓDIGO	MEDIDA	€/100		ESPEJOR MÁX. A FIJAR		
TCPB4213	4,2 x 13	6,090	PH2	6	500	12.000
TCPB4222	4,2 x 22	9,380	PH2	15	500	12.000
TCPB4232	4,2 x 32	12,697	PH2	25	500	6.000

CP-B

Pintado blanco. Huella PH



METAL



CÓDIGO	MEDIDA	€/100		ESPEJOR MÁX. A FIJAR		
TCPN4213	4,2 x 13	3,733	PH2	6	500	12.000
TCPN4222	4,2 x 22	5,617	PH2	15	500	12.000
TCPN4232	4,2 x 32	7,787	PH2	25	500	6.000

CP-N

Cincado negro. Huella PH



LACADO DE TORNILLOS COMPLETO



DIÁMETRO	LONGITUD	CANTIDAD MÍNIMA
Min. 2,9 mm - Max. 5,5 mm	Min. 6,5 mm - Max. 32 mm	15 Kgs (*) (* Por medida y color)

Colores disponibles

	RAL 3005 Rojo vino		RAL 9005 Negro intenso
	RAL 5009 Azul azur		RAL 9010 Blanco puro
	RAL 6005 Verde musgo		



LACADO DE TORNILLOS SOLO CABEZA



DIÁMETRO	LONGITUD	CANTIDAD MÍNIMA
Min. 3,9 mm - Max. 6,3 mm	Min. 13 mm - Max. 90 mm	(*) (* Consultar cantidad mínima)

Colores disponibles

	RAL 1000 Crema Bidasoa		RAL 7016 Gris antracita
	RAL 1001 Beige		RAL 7022 Gris sombra
	RAL 1007 Amarillo narciso		RAL 7024 Gris grafito
	RAL 1011 Beige pardo		RAL 7032 Gris guijarro
	RAL 1015 Marfil claro		RAL 7033 Gris cemento
	RAL 3002 Rojo carmin		RAL 7034 Gris amarillento
	RAL 3003 Rojo rubí		RAL 7035 Gris luminoso
	RAL 3004 Rojo púrpura		RAL 8003 Pardo arcilla
	RAL 3005 Rojo vino		RAL 8004 Pardo cobre
	RAL 3009 Rojo óxido		RAL 8012 Pardo rojo
	RAL 3011 Rojo pardo		RAL 8014 Sepia
	RAL 3020 Rojo tráfico		RAL 8017 Chocolate
	RAL 5002 Azul ultramar		RAL 8019 Pardo grisáceo
	RAL 5003 Azul zafiro		RAL 8025 Pardo pálido
	RAL 5005 Azul señales		RAL 9002 Blanco grisáceo
	RAL 5008 Azul grisáceo		RAL 9003 Blanco señales
	RAL 5009 Azul azur		RAL 9005 Negro intenso
	RAL 5010 Azul genciana		RAL 9006 Aluminio blanco
	RAL 5011 Azul acero		RAL 9007 Aluminio gris
	RAL 5019 Azul capri		RAL 9010 Blanco puro
	RAL 6005 Verde musgo		RAL 9011 Negro grafito
	RAL 6021 Verde pálido		RAL 9016 Blanco tráfico
	RAL 6028 Verde pino		RAL 9018 Blanco papiro
	RAL 7011 Gris hierro		

Ponemos a su disposición una amplia gama de tornillos, que podrá lacar a su gusto entre los colores disponibles.

142 DIN-7504-K



145 DIN-7504-K RE



151 DIN-7504-N HP



156 DIN-7981 HP



146 AUE



158 DIN-7982 HP





Tornillos para carpintería de PVC

PVC

METAL



CÓDIGO	MEDIDA	€/100			
P103925Z	3,9 x 25	3,293	PH2	1.000	12.000
P103930Z	3,9 x 30	4,047	PH2	1.000	12.000
P103938Z	3,9 x 38	4,393	PH2	500	6.000
P103945Z	3,9 x 45	5,673	PH2	500	3.000

PVC-10 Z

Cincado. Diámetro de cabeza 7,5 mm



Disponible en varios recubrimientos. Consulte precio y plazo de entrega.

METAL



CÓDIGO	MEDIDA	€/100			
P204325	4,3 x 25	3,507	PH2	1.000	12.000
P204330	4,3 x 30	3,817	PH2	1.000	6.000
P204338	4,3 x 38	4,787	PH2	500	6.000
P204345	4,3 x 45	5,417	PH2	500	3.000
P204355	4,3 x 55	6,600	PH2	500	3.000

PVC-20 B

Bicromatado. Diámetro de cabeza 7 mm



METAL



CÓDIGO	MEDIDA	€/100			
P204316Z	4,3 x 16	2,730	PH2	1.000	24.000
P204319Z	4,3 x 19	2,967	PH2	1.000	12.000
P204322Z	4,3 x 22	3,027	PH2	1.000	12.000
P204325Z	4,3 x 25	3,507	PH2	1.000	12.000
P204330Z	4,3 x 30	3,817	PH2	1.000	6.000
P204338Z	4,3 x 38	4,787	PH2	500	6.000
P204345Z	4,3 x 45	5,407	PH2	500	3.000
P204355Z	4,3 x 55	6,600	PH2	500	3.000

PVC-20 Z

Cincado. Diámetro de cabeza 7 mm



Disponible en varios recubrimientos. Consulte precio y plazo de entrega.

METAL



CÓDIGO	MEDIDA	€/100			
P304825	4,8 x 25	6,493	PH2	500	6.000
P304838	4,8 x 38	9,177	PH2	500	6.000

PVC-30

Bicromatado. Tornillo de reparación, diámetro de cabeza de 7,5 mm



METAL



CÓDIGO	MEDIDA	€/100			
P403916	3,9 x 16	3,233	PH2	1.000	16.000
P403919	3,9 x 19	3,457	PH2	1.000	12.000
P403925	3,9 x 25	3,977	PH2	1.000	12.000
P403932	3,9 x 32	4,997	PH2	1.000	6.000
P403938	3,9 x 38	5,607	PH2	500	6.000

PVC-40 B

Bicromatado. Punta broca piloto



PVC

Tornillos para carpintería de PVC

PVC-40 Z

Cincado. Punta broca piloto



Disponible en varios recubrimientos. Consulte precio y plazo de entrega.

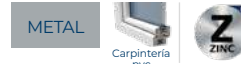

CÓDIGO	MEDIDA	€/100			
P403913Z	3,9 x 13	2,477	PH2	1.000	24.000
P403916Z	3,9 x 16	3,247	PH2	1.000	16.000
P403919Z	3,9 x 19	3,467	PH2	1.000	12.000
P403925Z	3,9 x 25	4,040	PH2	1.000	12.000
P403932Z	3,9 x 32	4,900	PH2	1.000	6.000
P403938Z	3,9 x 38	5,523	PH2	500	6.000

PVC-50 B

Bicromatado. Rosca métrica, punta broca



Disponible en varios recubrimientos. Consulte precio y plazo de entrega.



CÓDIGO	MEDIDA	€/100			
P50M416	M4 x 16	3,177	PH2	1.000	16.000
P50M419	M4 x 19	3,863	PH2	1.000	12.000
P50M425	M4 x 25	4,570	PH2	1.000	12.000
P50M432	M4 x 32	5,160	PH2	1.000	6.000
P50M438	M4 x 38	6,310	PH2	500	6.000

PVC-50 Z

Cincado. Rosca métrica, punta broca



Disponible en varios recubrimientos. Consulte precio y plazo de entrega.

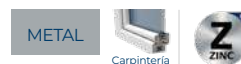

CÓDIGO	MEDIDA	€/100			
P50M413Z	M4 x 13	2,963	PH2	1.000	24.000
P50M416Z	M4 x 16	3,177	PH2	1.000	16.000
P50M419Z	M4 x 19	3,843	PH2	1.000	12.000
P50M425Z	M4 x 25	4,570	PH2	1.000	12.000
P50M432Z	M4 x 32	5,160	PH2	1.000	6.000

PVC-70

Bicromatado. Cabeza especial para tapón



Disponible en varios recubrimientos. Consulte precio y plazo de entrega.



CÓDIGO	MEDIDA	€/100			
P704855	4,8 x 55	11,223	PH2	500	3.000
P704865	4,8 x 65	14,797	PH2	500	2.000
P704880	4,8 x 80	18,663	PH2	250	1.500
P704895	4,8 x 95	26,513	PH2	250	1.500

PVC-70 TP

Tapón de nylon: blanco y negro para tornillo PVC-70



CÓDIGO	DIÁMETRO	COLOR	€/100		
P70TPBL	13		3,920	1.000	24.000
P70TPNG	13		3,920	1.000	24.000

PVC-90

Bicromatado. Cabeza alomada baja con arandela



CÓDIGO	MEDIDA	€/100			
P903510	3,5 x 10	3,820	PH2	1.000	24.000
P904017	4 x 17	5,013	PH2	1.000	12.000



Tornillos para carpintería de PVC

PVC

METAL



CÓDIGO	MEDIDA	€/100			
P100VEK	VEKAPLAST 4,8 x 10	20,447	PH2	500	6.000

PVC-VEK

VEKAPLAST con cabeza especial



Disponible en varios recubrimientos. Consulte precio y plazo de entrega.

METAL



CÓDIGO	MEDIDA	€/100			
P100VEK13	VEKAPLAST 4 x 10	18,930	PH2	500	12.000

PVC-VEK 13

VEKAPLAST con cabeza especial y broca



METAL



CÓDIGO	MEDIDA	€/100			
P100VEK10	VEKAPLAST 4 x 10	16,940	PH2	500	500

PVC-VEK 10

VEKAPLAST con cabeza especial



METAL



CÓDIGO	MEDIDA	€/100			
P100KOM10	KOMMERLING 5,5 x 10	20,963	PH2	500	6.000

PVC-KOM 10

KOMMERLING con cabeza especial



Disponible en varios recubrimientos. Consulte precio y plazo de entrega.



TORNILLOS PARA MADERA



TEX-BP

Bicromatado. Huella PZ



CÓDIGO	MEDIDA	€/100		UD. MIN. VENTA		
•TEXBP25010	2,5 x 10	1,290	PZ1	2.000	1.000	45.000
•TEXBP25012	2,5 x 12	1,347	PZ1	2.000	1.000	45.000
•TEXBP25016	2,5 x 16	1,513	PZ1	2.000	1.000	45.000
TEXBP25020	2,5 x 20	1,677	PZ1	2.000	1.000	24.000
TEXBP25025	2,5 x 25	1,867	PZ1	2.000	1.000	24.000
•TEXBP30010	3 x 10	1,533	PZ1	2.000	1.000	45.000
•TEXBP30012	3 x 12	1,620	PZ1	2.000	1.000	45.000
•TEXBP30015	3 x 15	1,753	PZ1	2.000	1.000	24.000
•TEXBP30016	3 x 16	1,790	PZ1	2.000	1.000	24.000
•TEXBP30020	3 x 20	1,977	PZ1	2.000	1.000	24.000
TEXBP30025	3 x 25	2,043	PZ1	2.000	1.000	24.000
TEXBP30030	3 x 30	2,757	PZ1	2.000	1.000	12.000
TEXBP30035	3 x 35	3,183	PZ1	2.000	1.000	12.000
TEXBP30040	3 x 40	3,843	PZ1	2.000	1.000	6.000
TEXBP30045	3 x 45	4,193	PZ1	1.000	500	6.000
•TEXBP35010	3,5 x 10	1,687	PZ2	2.000	1.000	24.000
•TEXBP35012	3,5 x 12	1,820	PZ2	2.000	1.000	24.000
•TEXBP35015	3,5 x 15	1,940	PZ2	2.000	1.000	24.000
•TEXBP35016	3,5 x 16	2,110	PZ2	2.000	1.000	24.000
•TEXBP35020	3,5 x 20	2,303	PZ2	2.000	1.000	24.000
TEXBP35025	3,5 x 25	2,663	PZ2	2.000	1.000	12.000
TEXBP35030	3,5 x 30	3,077	PZ2	2.000	1.000	12.000
TEXBP35035	3,5 x 35	3,860	PZ2	2.000	1.000	12.000
TEXBP35040	3,5 x 40	3,997	PZ2	1.000	500	6.000
TEXBP35045	3,5 x 45	5,583	PZ2	1.000	500	6.000
TEXBP35050	3,5 x 50	6,773	PZ2	1.000	500	6.000
•TEXBP40012	4 x 12	2,250	PZ2	2.000	1.000	24.000
•TEXBP40015	4 x 15	2,467	PZ2	2.000	1.000	24.000
•TEXBP40016	4 x 16	2,407	PZ2	2.000	1.000	24.000
•TEXBP40020	4 x 20	2,757	PZ2	2.000	1.000	12.000
•TEXBP40025	4 x 25	3,240	PZ2	2.000	1.000	12.000
TEXBP40030	4 x 30	3,693	PZ2	2.000	1.000	6.000
TEXBP40035	4 x 35	4,077	PZ2	1.000	500	6.000
TEXBP40040	4 x 40	4,467	PZ2	1.000	500	3.000
TEXBP40045	4 x 45	5,573	PZ2	1.000	500	3.000
TEXBP40050	4 x 50	5,603	PZ2	1.000	500	3.000
TEXBP40055	4 x 55	7,730	PZ2	500	250	1.500

CÓDIGO	MEDIDA	€/100		UD. MIN. VENTA		
TEXBP40060	4 x 60	8,373	PZ2	500	250	3.000
TEXBP40070	4 x 70	9,473	PZ2	500	250	1.500
TEXBP40080	4 x 80	11,093	PZ2	500	250	1.500
•TEXBP45016	4,5 x 16	3,077	PZ2	2.000	1.000	12.000
•TEXBP45020	4,5 x 20	3,530	PZ2	2.000	1.000	12.000
•TEXBP45025	4,5 x 25	4,110	PZ2	2.000	1.000	12.000
•TEXBP45030	4,5 x 30	4,463	PZ2	1.000	500	6.000
TEXBP45035	4,5 x 35	5,250	PZ2	1.000	500	6.000
TEXBP45040	4,5 x 40	5,570	PZ2	1.000	500	3.000
TEXBP45045	4,5 x 45	6,643	PZ2	500	250	3.000
TEXBP45050	4,5 x 50	6,953	PZ2	500	250	3.000
TEXBP45060	4,5 x 60	9,553	PZ2	500	250	1.500
TEXBP45070	4,5 x 70	12,577	PZ2	500	250	1.500
TEXBP45080	4,5 x 80	15,423	PZ2	200	100	1.200
•TEXBP50025	5 x 25	5,530	PZ2	2.000	1.000	6.000
•TEXBP50030	5 x 30	5,783	PZ2	1.000	500	6.000
TEXBP50035	5 x 35	6,190	PZ2	1.000	500	6.000
TEXBP50040	5 x 40	6,790	PZ2	1.000	500	6.000
TEXBP50045	5 x 45	7,887	PZ2	500	250	3.000
TEXBP50050	5 x 50	8,467	PZ2	500	250	3.000
TEXBP50060	5 x 60	10,537	PZ2	500	250	1.500
TEXBP50070	5 x 70	12,367	PZ2	400	200	1.200
TEXBP50080	5 x 80	16,473	PZ2	200	100	1.200
TEXBP50090	5 x 90	16,937	PZ2	200	100	1.200
TEXBP50100	5 x 100	22,467	PZ2	200	100	1.200
TEXBP50110	5 x 110	25,417	PZ2	200	100	1.200
TEXBP50120	5 x 120	28,813	PZ2	200	100	1.200
•TEXBP60040	6 x 40	12,940	PZ3	500	250	3.000
•TEXBP60045	6 x 45	13,780	PZ3	500	250	3.000
•TEXBP60050	6 x 50	15,370	PZ3	500	250	1.500
TEXBP60060	6 x 60	16,783	PZ3	500	250	1.500
TEXBP60070	6 x 70	18,580	PZ3	200	100	1.200
TEXBP60080	6 x 80	23,433	PZ3	200	100	1.200
TEXBP60090	6 x 90	27,530	PZ3	200	100	600
TEXBP60100	6 x 100	27,783	PZ3	200	100	600
TEXBP60110	6 x 110	37,347	PZ3	200	100	600
TEXBP60120	6 x 120	41,860	PZ3	200	100	600

• Medidas sin CE

Blister

CÓDIGO	MEDIDA	€/BOLSA	PCS.	BOLSAS
BZTXBP30016	3 x 16	2,565	40	20
BZTXBP30020	3 x 20	2,565	40	20
BZTXBP30025	3 x 25	2,565	40	20
BZTXBP30030	3 x 30	2,565	40	20
BZTXBP35016	3,5 x 16	2,565	40	20
BZTXBP35020	3,5 x 20	2,565	40	20
BZTXBP35025	3,5 x 25	2,565	40	20
BZTXBP35030	3,5 x 30	2,565	40	20
BZTXBP35035	3,5 x 35	2,565	20	20
BZTXBP35040	3,5 x 40	2,565	20	20
BZTXBP35050	3,5 x 50	2,565	20	20
BZTXBP40025	4 x 25	2,565	40	20
BZTXBP40030	4 x 30	2,565	20	20
BZTXBP40035	4 x 35	2,565	20	20
BZTXBP40040	4 x 40	2,565	20	20
BZTXBP40045	4 x 45	2,565	20	20
BZTXBP40050	4 x 50	2,565	10	20
BZTXBP40060	4 x 60	2,565	10	20
BZTXBP45030	4,5 x 30	2,565	20	20
BZTXBP45035	4,5 x 35	2,565	20	20
BZTXBP45040	4,5 x 40	2,565	20	20
BZTXBP45045	4,5 x 45	2,565	10	20
BZTXBP45050	4,5 x 50	2,565	10	20
BZTXBP45060	4,5 x 60	2,565	10	20
BZTXBP45070	4,5 x 70	2,565	10	20
BZTXBP50030	5 x 30	2,565	10	20
BZTXBP50035	5 x 35	2,565	10	20
BZTXBP50040	5 x 40	2,565	10	20
BZTXBP50050	5 x 50	2,565	10	20
BZTXBP50060	5 x 60	2,565	10	20
BZTXBP50070	5 x 70	2,565	4	20
BZTXBP50080	5 x 80	2,565	4	20
BZTXBP60050	6 x 50	2,565	10	20
BZTXBP60060	6 x 60	2,565	10	20
BZTXBP60070	6 x 70	2,565	4	20
BZTXBP60080	6 x 80	2,565	4	20

Caja con Ventana

CÓDIGO	MEDIDA	€/CAJA	PCS.	CAJAS
VTEXBP30016	3 x 16	4,758	200	8
VTEXBP30020	3 x 20	5,266	200	8
VTEXBP30025	3 x 25	5,318	200	8
VTEXBP30030	3 x 30	6,060	170	8
VTEXBP30040	3 x 40	5,960	120	8
VTEXBP35016	3,5 x 16	5,623	200	8
VTEXBP35020	3,5 x 20	6,131	200	8
VTEXBP35025	3,5 x 25	6,017	170	8
VTEXBP35030	3,5 x 30	6,144	150	8
VTEXBP35035	3,5 x 35	5,147	100	8
VTEXBP35040	3,5 x 40	3,873	75	8
VTEXBP35050	3,5 x 50	6,565	75	8
VTEXBP40025	4 x 25	5,441	125	8
VTEXBP40030	4 x 30	5,048	100	8
VTEXBP40035	4 x 35	3,949	75	8
VTEXBP40040	4 x 40	4,199	75	8
VTEXBP40045	4 x 45	5,402	75	8
VTEXBP40050	4 x 50	3,616	50	8
VTEXBP40060	4 x 60	5,409	50	8
VTEXBP45030	4,5 x 30	5,933	100	8
VTEXBP45035	4,5 x 35	5,234	75	8
VTEXBP45040	4,5 x 40	5,247	75	8
VTEXBP45045	4,5 x 45	4,640	50	8
VTEXBP45050	4,5 x 50	4,540	50	8
VTEXBP45060	4,5 x 60	6,497	50	8
VTEXBP45070	4,5 x 70	7,969	50	8
VTEXBP50030	5 x 30	5,655	75	8
VTEXBP50035	5 x 35	6,001	75	8
VTEXBP50040	5 x 40	4,731	50	8
VTEXBP50050	5 x 50	5,473	50	8
VTEXBP50060	5 x 60	3,441	25	8
VTEXBP50070	5 x 70	4,310	25	8
VTEXBP50080	5 x 80	5,223	25	8
VTEXBP50090	5 x 90	5,632	25	8
VTEXBP60050	6 x 50	7,794	40	8
VTEXBP60060	6 x 60	6,378	30	8
VTEXBP60070	6 x 70	4,802	20	8
VTEXBP60080	6 x 80	6,060	20	8

MADERA



TEX-ZP

Cincado. Huella PZ

CÓDIGO	MEDIDA	€/100	UD. MIN. VENTA	1.000	2.000	3.000
•TEXZP25010	2,5 x 10	1,290	PZ1	2.000	1.000	45.000
•TEXZP25012	2,5 x 12	1,347	PZ1	2.000	1.000	45.000
•TEXZP25016	2,5 x 16	1,513	PZ1	2.000	1.000	45.000
TEXZP25020	2,5 x 20	1,677	PZ1	2.000	1.000	45.000
TEXZP25025	2,5 x 25	1,867	PZ1	2.000	1.000	45.000
•TEXZP30010	3 x 10	1,533	PZ1	2.000	1.000	45.000
•TEXZP30012	3 x 12	1,620	PZ1	2.000	1.000	45.000
•TEXZP30015	3 x 15	1,753	PZ1	2.000	1.000	24.000
•TEXZP30016	3 x 16	1,790	PZ1	2.000	1.000	24.000
•TEXZP30020	3 x 20	1,977	PZ1	2.000	1.000	24.000
TEXZP30025	3 x 25	2,043	PZ1	2.000	1.000	24.000
TEXZP30030	3 x 30	2,757	PZ1	2.000	1.000	12.000
TEXZP30035	3 x 35	3,183	PZ1	2.000	1.000	12.000
TEXZP30040	3 x 40	3,843	PZ1	2.000	1.000	6.000
TEXZP30045	3 x 45	4,193	PZ1	1.000	500	6.000
•TEXZP35010	3,5 x 10	1,687	PZ2	2.000	1.000	24.000
•TEXZP35012	3,5 x 12	1,820	PZ2	2.000	1.000	24.000
•TEXZP35015	3,5 x 15	1,940	PZ2	2.000	1.000	24.000
•TEXZP35016	3,5 x 16	2,110	PZ2	2.000	1.000	24.000
•TEXZP35020	3,5 x 20	2,303	PZ2	2.000	1.000	24.000
TEXZP35025	3,5 x 25	2,663	PZ2	2.000	1.000	12.000
TEXZP35030	3,5 x 30	3,077	PZ2	2.000	1.000	12.000
TEXZP35035	3,5 x 35	3,860	PZ2	2.000	1.000	12.000
TEXZP35040	3,5 x 40	3,997	PZ2	1.000	500	6.000
TEXZP35045	3,5 x 45	5,583	PZ2	1.000	500	6.000
TEXZP35050	3,5 x 50	6,773	PZ2	1.000	500	6.000
•TEXZP40012	4 x 12	2,250	PZ2	2.000	1.000	24.000
•TEXZP40015	4 x 15	2,467	PZ2	2.000	1.000	24.000
•TEXZP40016	4 x 16	2,407	PZ2	2.000	1.000	24.000
•TEXZP40020	4 x 20	2,757	PZ2	2.000	1.000	12.000
•TEXZP40025	4 x 25	3,240	PZ2	2.000	1.000	12.000
TEXZP40030	4 x 30	3,693	PZ2	2.000	1.000	6.000
TEXZP40035	4 x 35	4,077	PZ2	1.000	500	6.000
TEXZP40040	4 x 40	4,467	PZ2	1.000	500	3.000
TEXZP40045	4 x 45	5,573	PZ2	1.000	500	3.000
TEXZP40050	4 x 50	5,603	PZ2	1.000	500	3.000
TEXZP40055	4 x 55	7,730	PZ2	500	250	3.000

CÓDIGO	MEDIDA	€/100	UD. MIN. VENTA	1.000	2.000	3.000
TEXZP40060	4 x 60	8,373	PZ2	500	250	3.000
TEXZP40070	4 x 70	9,473	PZ2	500	250	1.500
TEXZP40080	4 x 80	11,093	PZ2	500	250	1.500
•TEXZP45016	4,5 x 16	3,077	PZ2	2.000	1.000	12.000
•TEXZP45020	4,5 x 20	3,530	PZ2	2.000	1.000	12.000
•TEXZP45025	4,5 x 25	4,110	PZ2	2.000	1.000	12.000
•TEXZP45030	4,5 x 30	4,463	PZ2	1.000	500	6.000
TEXZP45035	4,5 x 35	5,250	PZ2	1.000	500	6.000
TEXZP45040	4,5 x 40	5,570	PZ2	1.000	500	3.000
TEXZP45045	4,5 x 45	6,643	PZ2	500	250	3.000
TEXZP45050	4,5 x 50	6,953	PZ2	500	250	3.000
TEXZP45060	4,5 x 60	9,553	PZ2	500	250	1.500
TEXZP45070	4,5 x 70	12,577	PZ2	500	250	1.500
TEXZP45080	4,5 x 80	15,423	PZ2	200	100	1.200
•TEXZP50025	5 x 25	5,530	PZ2	2.000	1.000	6.000
•TEXZP50030	5 x 30	5,783	PZ2	1.000	500	6.000
TEXZP50035	5 x 35	6,190	PZ2	1.000	500	6.000
TEXZP50040	5 x 40	6,790	PZ2	1.000	500	6.000
TEXZP50045	5 x 45	7,887	PZ2	500	250	3.000
TEXZP50050	5 x 50	8,467	PZ2	500	250	3.000
TEXZP50060	5 x 60	10,537	PZ2	500	250	1.500
TEXZP50070	5 x 70	12,367	PZ2	400	200	1.200
TEXZP50080	5 x 80	16,473	PZ2	200	100	1.200
TEXZP50090	5 x 90	16,937	PZ2	200	100	1.200
TEXZP50100	5 x 100	22,467	PZ2	200	100	1.200
TEXZP50110	5 x 110	25,417	PZ2	200	100	1.200
TEXZP50120	5 x 120	28,813	PZ2	200	100	1.200
•TEXZP60040	6 x 40	12,940	PZ3	500	250	3.000
•TEXZP60045	6 x 45	13,780	PZ3	500	250	3.000
•TEXZP60050	6 x 50	15,370	PZ3	500	250	1.500
TEXZP60060	6 x 60	16,783	PZ3	500	250	1.500
TEXZP60070	6 x 70	18,580	PZ3	200	100	600
TEXZP60080	6 x 80	23,433	PZ3	200	100	1.200
TEXZP60090	6 x 90	27,530	PZ3	200	100	1.200
TEXZP60100	6 x 100	27,783	PZ3	200	100	600
TEXZP60110	6 x 110	37,347	PZ3	200	100	600
TEXZP60120	6 x 120	41,860	PZ3	200	100	600

• Medidas sin CE



Disponible en varios recubrimientos. Consulte precio y plazo de entrega.

CÓDIGO	MEDIDA	€/CAJA	PCS. CAJAS
BZTXZP30016	3 x 16	2,565	40 20
BZTXZP30020	3 x 20	2,565	40 20
BZTXZP30025	3 x 25	2,565	40 20
BZTXZP30030	3 x 30	2,565	40 20
BZTXZP35016	3,5 x 16	2,565	40 20
BZTXZP35020	3,5 x 20	2,565	40 20
BZTXZP35025	3,5 x 25	2,565	40 20
BZTXZP35030	3,5 x 30	2,565	40 20
BZTXZP35035	3,5 x 35	2,565	20 20
BZTXZP35040	3,5 x 40	2,565	20 20
BZTXZP35050	3,5 x 50	2,565	20 20
BZTXZP40025	4 x 25	2,565	40 20
BZTXZP40030	4 x 30	2,565	20 20
BZTXZP40035	4 x 35	2,565	20 20
BZTXZP40040	4 x 40	2,565	20 20
BZTXZP40045	4 x 45	2,565	20 20
BZTXZP40050	4 x 50	2,565	10 20
BZTXZP40060	4 x 60	2,565	10 20
BZTXZP45030	4,5 x 30	2,565	20 20
BZTXZP45035	4,5 x 35	2,565	20 20
BZTXZP45040	4,5 x 40	2,565	20 20
BZTXZP45045	4,5 x 45	2,565	10 20
BZTXZP45050	4,5 x 50	2,565	10 20
BZTXZP45060	4,5 x 60	2,565	10 20
BZTXZP45070	4,5 x 70	2,565	10 20
BZTXZP50030	5 x 30	2,565	10 20
BZTXZP50035	5 x 35	2,565	10 20
BZTXZP50040	5 x 40	2,565	10 20
BZTXZP50050	5 x 50	2,565	10 20
BZTXZP50060	5 x 60	2,565	10 20
BZTXZP50070	5 x 70	2,565	4 20
BZTXZP50080	5 x 80	2,565	4 20
BZTXZP60050	6 x 50	2,565	10 20
BZTXZP60060	6 x 60	2,565	10 20
BZTXZP60070	6 x 70	2,565	4 20
BZTXZP60080	6 x 80	2,565	4 20
VTEXZP30016	3 x 16	4,758	200 8
VTEXZP30020	3 x 20	5,266	200 8
VTEXZP30025	3 x 25	5,318	200 8
VTEXZP30030	3 x 30	6,060	170 8
VTEXZP30040	3 x 40	5,960	120 8
VTEXZP35016	3,5 x 16	5,623	200 8
VTEXZP35020	3,5 x 20	6,131	200 8
VTEXZP35025	3,5 x 25	6,017	170 8
VTEXZP35030	3,5 x 30	6,144	150 8
VTEXZP35035	3,5 x 35	5,147	100 8
VTEXZP35040	3,5 x 40	3,873	75 8
VTEXZP35050	3,5 x 50	6,565	75 8
VTEXZP40025	4 x 25	5,441	125 8
VTEXZP40030	4 x 30	5,048	100 8
VTEXZP40035	4 x 35	3,949	75 8
VTEXZP40040	4 x 40	4,199	75 8
VTEXZP40045	4 x 45	5,402	75 8
VTEXZP40050	4 x 50	3,616	50 8
VTEXZP40060	4 x 60	5,409	50 8
VTEXZP45030	4,5 x 30	5,933	100 8
VTEXZP45035	4,5 x 35	5,234	75 8
VTEXZP45040	4,5 x 40	5,247	75 8
VTEXZP45045	4,5 x 45	4,640	50 8
VTEXZP45050	4,5 x 50	4,540	50 8
VTEXZP45060	4,5 x 60	6,497	50 8
VTEXZP45070	4,5 x 70	7,969	50 8
VTEXZP50030	5 x 30	5,655	75 8
VTEXZP50035	5 x 35	6,001	75 8
VTEXZP50040	5 x 40	4,731	50 8
VTEXZP50045	5 x 45	5,366	50 8
VTEXZP50050	5 x 50	5,473	50 8
VTEXZP50060	5 x 60	3,441	25 8
VTEXZP50070	5 x 70	4,310	25 8
VTEXZP50080	5 x 80	5,223	25 8
VTEXZP60050	6 x 50	7,794	40 8
VTEXZP60060	6 x 60	6,378	30 8
VTEXZP60070	6 x 70	4,802	20 8
VTEXZP60080	6 x 80	6,060	20 8

Blister

Caja con Ventana

CÓDIGO	MEDIDA	€/BOLSA	PCS. BOLSAS
BZTXZP30016	3 x 16	2,565	40 20
BZTXZP30020	3 x 20	2,565	40 20
BZTXZP30025	3 x 25	2,565	40 20
BZTXZP30030	3 x 30	2,565	40 20
BZTXZP35016	3,5 x 16	2,565	40 20
BZTXZP35020	3,5 x 20	2,565	40 20
BZTXZP35025	3,5 x 25	2,565	40 20
BZTXZP35030	3,5 x 30	2,565	40 20
BZTXZP35035	3,5 x 35	2,565	20 20
BZTXZP35040	3,5 x 40	2,565	20 20
BZTXZP35050	3,5 x 50	2,565	20 20
BZTXZP40025	4 x 25	2,565	40 20
BZTXZP40030	4 x 30	2,565	20 20
BZTXZP40035	4 x 35	2,565	20 20
BZTXZP40040	4 x 40	2,565	20 20
BZTXZP40045	4 x 45	2,565	20 20
BZTXZP40050	4 x 50	2,565	10 20
BZTXZP40060	4 x 60	2,565	10 20
BZTXZP45030	4,5 x 30	2,565	20 20
BZTXZP45035	4,5 x 35	2,565	20 20
BZTXZP45040	4,5 x 40	2,565	20 20
BZTXZP45045	4,5 x 45	2,565	10 20
BZTXZP45050	4,5 x 50	2,565	10 20
BZTXZP45060	4,5 x 60	2,565	10 20
BZTXZP45070	4,5 x 70	2,565	10 20
BZTXZP50030	5 x 30	2,565	10 20
BZTXZP50035	5 x 35	2,565	10 20
BZTXZP50040	5 x 40	2,565	10 20
BZTXZP50050	5 x 50	2,565	10 20
BZTXZP50060	5 x 60	2,565	10 20
BZTXZP50070	5 x 70	2,565	4 20
BZTXZP50080	5 x 80	2,565	4 20
BZTXZP60050	6 x 50	2,565	10 20
BZTXZP60060	6 x 60	2,565	10 20
BZTXZP60070	6 x 70	2,565	4 20
BZTXZP60080	6 x 80	2,565	4 20

TEX-BT

Bicromatado. Huella TX



CÓDIGO	MEDIDA	€/100		UD. MIN. VENTA		
•TEXBT30016	3 x 16	2,223	TX10	2.000	1.000	24.000
•TEXBT30020	3 x 20	2,417	TX10	2.000	1.000	24.000
TEXBT30025	3 x 25	2,983	TX10	2.000	1.000	24.000
TEXBT30030	3 x 30	3,407	TX10	2.000	1.000	12.000
TEXBT30035	3 x 35	3,710	TX10	2.000	1.000	12.000
TEXBT30040	3 x 40	4,127	TX10	2.000	1.000	6.000
•TEXBT35012	3,5 x 12	2,557	TX15	2.000	1.000	24.000
•TEXBT35016	3,5 x 16	2,690	TX15	2.000	1.000	24.000
•TEXBT35020	3,5 x 20	2,893	TX15	2.000	1.000	24.000
TEXBT35025	3,5 x 25	3,617	TX15	2.000	1.000	12.000
TEXBT35030	3,5 x 30	3,913	TX15	2.000	1.000	12.000
TEXBT35035	3,5 x 35	4,397	TX15	2.000	1.000	12.000
TEXBT35040	3,5 x 40	5,327	TX15	1.000	500	6.000
TEXBT35045	3,5 x 45	5,833	TX15	1.000	500	6.000
TEXBT35050	3,5 x 50	6,143	TX15	1.000	500	6.000
•TEXBT40016	4 x 16	2,667	TX20	2.000	1.000	24.000
•TEXBT40020	4 x 20	3,033	TX20	2.000	1.000	12.000
•TEXBT40025	4 x 25	3,600	TX20	2.000	1.000	12.000
TEXBT40030	4 x 30	4,063	TX20	2.000	1.000	6.000
TEXBT40035	4 x 35	4,530	TX20	1.000	500	6.000
TEXBT40040	4 x 40	4,870	TX20	1.000	500	3.000
TEXBT40045	4 x 45	6,133	TX20	1.000	500	3.000
TEXBT40050	4 x 50	6,163	TX20	1.000	500	3.000
TEXBT40055	4 x 55	8,503	TX20	500	250	3.000
TEXBT40060	4 x 60	9,297	TX20	500	250	3.000
TEXBT40070	4 x 70	10,417	TX20	500	250	1.500
TEXBT45025	4,5 x 25	4,773	TX20	2.000	1.000	12.000
TEXBT45030	4,5 x 30	4,907	TX20	1.000	500	6.000
TEXBT45035	4,5 x 35	5,777	TX20	1.000	500	6.000
TEXBT45040	4,5 x 40	5,753	TX20	1.000	500	3.000
TEXBT45045	4,5 x 45	7,097	TX20	500	250	3.000
TEXBT45050	4,5 x 50	7,353	TX20	500	250	3.000
TEXBT45060	4,5 x 60	10,597	TX20	500	250	1.500
TEXBT45070	4,5 x 70	13,860	TX20	500	250	1.500
TEXBT45080	4,5 x 80	17,693	TX20	200	100	1.200
TEXBT50030	5 x 30	6,483	TX25	1.000	500	6.000
TEXBT50035	5 x 35	6,960	TX25	1.000	500	6.000
TEXBT50040	5 x 40	7,610	TX25	1.000	500	6.000
TEXBT50045	5 x 45	9,070	TX25	500	250	3.000
TEXBT50050	5 x 50	9,493	TX25	500	250	3.000
TEXBT50060	5 x 60	11,930	TX25	500	250	1.500
TEXBT50070	5 x 70	13,860	TX25	400	200	1.200
TEXBT50080	5 x 80	18,450	TX25	200	100	1.200
TEXBT50090	5 x 90	19,160	TX25	200	100	1.200
TEXBT50100	5 x 100	25,160	TX25	200	100	1.200
TEXBT50120	5 x 120	32,290	TX25	200	100	1.200
TEXBT60040	6 x 40	14,123	TX30	500	250	3.000
TEXBT60045	6 x 45	15,217	TX30	500	250	3.000
TEXBT60050	6 x 50	16,873	TX30	500	250	1.500
TEXBT60060	6 x 60	19,300	TX30	500	250	1.500
TEXBT60070	6 x 70	21,390	TX30	200	100	1.200
TEXBT60080	6 x 80	26,073	TX30	200	100	1.200
TEXBT60090	6 x 90	30,030	TX30	200	100	600
TEXBT60100	6 x 100	31,950	TX30	200	100	600
TEXBT60110	6 x 110	42,053	TX30	200	100	600
TEXBT60120	6 x 120	48,057	TX30	200	100	1.200
TEXBT60130	6 x 130	48,457	TX30	200	100	600
TEXBT60140	6 x 140	57,393	TX30	200	100	600
TEXBT60150	6 x 150	65,223	TX30	200	100	600
TEXBT60160	6 x 160	80,890	TX30	100	100	600
TEXBT60180	6 x 180	102,067	TX30	100	100	800
TEXBT60200	6 x 200	131,553	TX30	100	100	800
TEXBT60220	6 x 220	144,963	TX30	100	100	-
TEXBT60240	6 x 240	164,107	TX30	100	100	-
TEXBT60260	6 x 260	194,807	TX30	100	100	-
TEXBT60280	6 x 280	216,700	TX30	100	100	-
TEXBT60300	6 x 300	232,253	TX30	100	100	-
TEXBT80080	8 x 80	51,590	TX40	200	100	600
TEXBT80100	8 x 100	55,317	TX40	100	50	300
TEXBT80120	8 x 120	82,090	TX40	100	50	300
TEXBT80140	8 x 140	87,810	TX40	50	50	300
TEXBT80160	8 x 160	128,560	TX40	50	50	300
TEXBT80180	8 x 180	136,557	TX40	50	50	150
TEXBT80200	8 x 200	153,763	TX40	50	50	400
TEXBT80220	8 x 220	183,180	TX40	50	50	400
TEXBT80240	8 x 240	200,480	TX40	50	50	400
TEXBT80260	8 x 260	234,790	TX40	50	50	-
TEXBT80280	8 x 280	252,000	TX40	50	50	-
TEXBT80300	8 x 300	258,677	TX40	50	50	200
TEXBT80320	8 x 320	318,303	TX40	50	50	-
TEXBT80340	8 x 340	355,320	TX40	50	50	-
TEXBT80360	8 x 360	392,573	TX40	50	50	-
TEXBT80380	8 x 380	452,687	TX40	50	50	-
TEXBT80400	8 x 400	475,457	TX40	50	50	-
TEXBT10080	10 x 80	85,667	TX40	50	50	-
TEXBT10100	10 x 100	108,630	TX40	50	50	400
TEXBT10120	10 x 120	136,177	TX40	50	50	-
TEXBT10140	10 x 140	164,263	TX40	50	50	-
TEXBT10160	10 x 160	191,823	TX40	50	50	-
TEXBT10180	10 x 180	257,870	TX40	50	50	-
TEXBT10200	10 x 200	289,697	TX40	50	50	-
TEXBT10220	10 x 220	319,833	TX40	50	50	-
TEXBT10240	10 x 240	352,840	TX40	50	50	-

• Medidas sin CE



CÓDIGO	MEDIDA	€/100		UD. MIN. VENTA		
•TEXZT30016	3 x 16	2,223	TX10	2.000	1.000	24.000
•TEXZT30020	3 x 20	2,417	TX10	2.000	1.000	24.000
•TEXZT30025	3 x 25	2,983	TX10	2.000	1.000	24.000
TEXZT30030	3 x 30	3,407	TX10	2.000	1.000	12.000
TEXZT30035	3 x 35	3,710	TX10	2.000	1.000	12.000
TEXZT30040	3 x 40	4,127	TX10	2.000	1.000	6.000
•TEXZT35012	3,5 x 12	2,557	TX15	2.000	1.000	24.000
•TEXZT35016	3,5 x 16	2,690	TX15	2.000	1.000	24.000
•TEXZT35020	3,5 x 20	2,893	TX15	2.000	1.000	24.000
TEXZT35025	3,5 x 25	3,617	TX15	2.000	1.000	12.000
TEXZT35030	3,5 x 30	3,913	TX15	2.000	1.000	12.000
TEXZT35035	3,5 x 35	4,397	TX15	2.000	1.000	12.000
TEXZT35040	3,5 x 40	5,327	TX15	1.000	500	6.000
TEXZT35045	3,5 x 45	5,833	TX15	1.000	500	6.000
TEXZT35050	3,5 x 50	6,143	TX15	1.000	500	6.000
•TEXZT40016	4 x 16	2,667	TX20	2.000	1.000	24.000
•TEXZT40020	4 x 20	3,033	TX20	2.000	1.000	12.000
•TEXZT40025	4 x 25	3,600	TX20	2.000	1.000	12.000
TEXZT40030	4 x 30	4,063	TX20	2.000	1.000	6.000
TEXZT40035	4 x 35	4,530	TX20	1.000	500	6.000
TEXZT40040	4 x 40	4,870	TX20	1.000	500	6.000
TEXZT40045	4 x 45	6,133	TX20	1.000	500	6.000
TEXZT40050	4 x 50	6,163	TX20	1.000	500	6.000
TEXZT40055	4 x 55	8,503	TX20	500	250	3.000
TEXZT40060	4 x 60	9,297	TX20	500	250	3.000
TEXZT40070	4 x 70	10,417	TX20	500	250	1.500
TEXZT45030	4,5 x 30	4,907	TX20	1.000	500	6.000
TEXZT45035	4,5 x 35	5,777	TX20	1.000	500	6.000
TEXZT45040	4,5 x 40	5,753	TX20	1.000	500	3.000
TEXZT45050	4,5 x 50	7,353	TX20	500	250	3.000
TEXZT45060	4,5 x 60	10,597	TX20	500	250	1.500

CÓDIGO	MEDIDA	€/100		UD. MIN. VENTA		
TEXZT45070	4,5 x 70	13,860	TX20	500	250	1.500
TEXZT45080	4,5 x 80	17,693	TX20	200	100	1.200
•TEXZT50030	5 x 30	6,483	TX25	1.000	500	6.000
TEXZT50035	5 x 35	6,960	TX25	1.000	500	6.000
TEXZT50040	5 x 40	7,610	TX25	1.000	500	6.000
TEXZT50045	5 x 45	9,070	TX25	500	250	3.000
TEXZT50050	5 x 50	9,493	TX25	500	250	3.000
TEXZT50060	5 x 60	11,930	TX25	500	250	1.500
TEXZT50070	5 x 70	13,860	TX25	400	200	1.200
TEXZT50080	5 x 80	18,450	TX25	200	100	1.200
TEXZT50090	5 x 90	19,160	TX25	200	100	1.200
TEXZT50100	5 x 100	25,160	TX25	200	100	1.200
•TEXZT60050	6 x 50	16,873	TX30	500	250	1.500
TEXZT60060	6 x 60	19,300	TX30	500	250	1.500
TEXZT60070	6 x 70	21,390	TX30	200	100	1.200
TEXZT60080	6 x 80	26,073	TX30	200	100	1.200
TEXZT60090	6 x 90	30,030	TX30	200	100	600
TEXZT60100	6 x 100	31,950	TX30	200	100	600
TEXZT60110	6 x 110	42,053	TX30	200	100	600
TEXZT60120	6 x 120	48,057	TX30	200	100	600
TEXZT60130	6 x 130	48,457	TX30	100	100	600
TEXZT60140	6 x 140	57,393	TX30	100	100	600
TEXZT60150	6 x 150	65,223	TX30	100	100	600
TEXZT60160	6 x 160	80,890	TX30	100	100	600
TEXZT60180	6 x 180	102,067	TX30	100	100	800
TEXZT60200	6 x 200	131,553	TX30	100	100	300
TEXZT60220	6 x 220	144,963	TX30	100	100	
TEXZT60240	6 x 240	164,107	TX30	100	100	600
TEXZT60260	6 x 260	194,807	TX30	100	100	-
TEXZT60280	6 x 280	216,700	TX30	100	100	-
TEXZT60300	6 x 300	232,253	TX30	100	100	-

• Medidas sin CE



Disponible en varios recubrimientos. Consulte precio y plazo de entrega.



CÓDIGO	MEDIDA	€/100			
TEXA250050	5 x 50	27,153	TX25	250	3.000
TEXA250060	5 x 60	32,627	TX25	100	2.400
TEXA250070	5 x 70	36,980	TX25	100	2.400



CÓDIGO	MEDIDA	€/BOLSA	PCS.	BOLSAS
BZTXA250050	5 x 50	2,565	4	20
BZTXA250060	5 x 60	2,565	4	20
BZTXA250070	5 x 70	2,565	2	20



CÓDIGO	MEDIDA	€/CAJA	PCS.	CAJAS
VTEXA250050	5 x 50	6,988	20	8
VTEXA250060	5 x 60	8,395	20	8
VTEXA250070	5 x 70	9,519	20	8



INDEX

A PERFECT FIXING

Expositor

Tornillería para madera



BLISTER



CAJA CON VENTANA



CAJA PROFESIONAL

DIMENSIONES
Ancho: 100 cm
Alto: 240 cm



Tirafondo de alto rendimiento

TEX



CÓDIGO	MEDIDA	€/100			
TECBT60080	6 x 80	33,593	TX30	200	1.200
TECBT60100	6 x 100	39,110	TX30	100	1.200
TECBT60120	6 x 120	61,920	TX30	100	600
TECBT60140	6 x 140	73,947	TX30	100	600
TECBT60160	6 x 160	104,220	TX30	100	400
TECBT60180	6 x 180	131,507	TX30	100	-
TECBT60200	6 x 200	169,497	TX40	100	-
TECBT80080	8 x 80	66,467	TX40	50	600
TECBT80100	8 x 100	68,837	TX40	50	300
TECBT80120	8 x 120	105,757	TX40	50	300
TECBT80140	8 x 140	110,173	TX40	50	300
TECBT80160	8 x 160	160,563	TX40	50	200
TECBT80180	8 x 180	167,153	TX40	50	-
TECBT80200	8 x 200	188,210	TX40	50	-
TECBT80220	8 x 220	236,017	TX40	50	-

CÓDIGO	MEDIDA	€/100			
TECBT80240	8 x 240	245,387	TX40	50	-
TECBT80260	8 x 260	287,387	TX40	50	-
TECBT80280	8 x 280	308,447	TX40	50	-
TECBT80300	8 x 300	329,813	TX40	50	-
TECBT10100	10 x 100	132,963	TX40	50	300
TECBT10120	10 x 120	166,680	TX40	50	300
TECBT10140	10 x 140	201,053	TX40	50	300
TECBT10160	10 x 160	234,790	TX40	50	200
TECBT10180	10 x 180	315,630	TX40	50	-
TECBT10200	10 x 200	354,593	TX40	25	-
TECBT10220	10 x 220	391,480	TX40	25	-
TECBT10240	10 x 240	431,870	TX40	25	-
TECBT10260	10 x 260	479,673	TX40	25	-
TECBT10280	10 x 280	538,170	TX40	25	-
TECBT10300	10 x 300	589,317	TX40	25	-

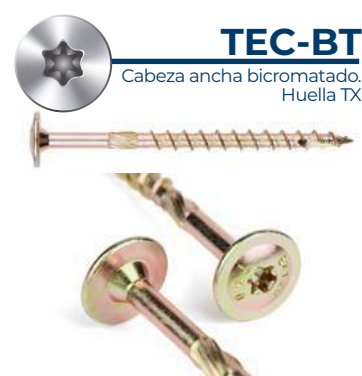

TEC-BT
Cabeza ancha bicromatado.
Huella TX



CÓDIGO	MEDIDA	€/100		
TEXABM06	Ø6	52,573	100	2.400
TEXABM08	Ø8	67,770	100	2.400
TEXABM10	Ø10	114,980	100	1.200

TEX-AB

Arandela cónica



Mayor rendimiento

Mejora las prestaciones mediante una mayor superficie de fijación.

INDEXwood VI

**SOFTWARE DE DISEÑO
PARA EL CÁLCULO DE
ESTRUCTURAS DE MADERA**

Permite realizar cálculos de fijaciones estructurales en madera con tirafondos, de acuerdo con el Eurocódigo 5 (norma EN 1995-1-1).



TEX

TIRAFONDO DE ALTAS PRESTACIONES PARA MADERA



CARACTERÍSTICAS TORNILLOS TEX • TABLA COMPARATIVA

TECBT	TEXBT	TEXBP	TEXZT	TEXZP	Ø	LONGITUD TORNILLO	LONGITUD ROSCA	LIMPIADOR	PUNTA ULTRA AFILADA	HUELLA
-	-	TEXBP25010	-	TEXZP25010	2,5	10	COMPLETA	-	-	PZ1
-	-	TEXBP25012	-	TEXZP25012		12				
-	-	TEXBP25016	-	TEXZP25016		16				
-	-	TEXBP25020	-	TEXZP25020		20				
-	-	TEXBP25025	-	TEXZP25025		25				
-	-	TEXBP30010	-	TEXZP30010	3	10	COMPLETA	-	-	PZ1
-	-	TEXBP30012	-	TEXZP30012		12				
-	-	TEXBP30015	-	TEXZP30015		15				
-	TEXBT30016	TEXBP30016	TEXZT30016	TEXZP30016		16				
-	TEXBT30020	TEXBP30020	TEXZT30020	TEXZP30020		20				
-	TEXBT30025	TEXBP30025	TEXZT30025	TEXZP30025		25				
-	TEXBT30030	TEXBP30030	TEXZT30030	TEXZP30030		30				
-	TEXBT30035	TEXBP30035	TEXZT30035	TEXZP30035		35				
-	TEXBT30040	TEXBP30040	TEXZT30040	TEXZP30040		40				
-	-	TEXBP30045	-	TEXZP30045		45				
-	-	TEXBP35010	-	TEXZP35010	3,5	10	COMPLETA	-	-	PZ2
-	TEXBT35012	TEXBP35012	TEXZT35012	TEXZP35012		12				
-	-	TEXBP35015	-	TEXZP35015		15				
-	TEXBT35016	TEXBP35016	TEXZT35016	TEXZP35016		16				
-	TEXBT35020	TEXBP35020	TEXZT35020	TEXZP35020		20				
-	TEXBT35025	TEXBP35025	TEXZT35025	TEXZP35025		25				
-	TEXBT35030	TEXBP35030	TEXZT35030	TEXZP35030		30				
-	TEXBT35035	TEXBP35035	TEXZT35035	TEXZP35035		35				
-	TEXBT35040	TEXBP35040	TEXZT35040	TEXZP35040		40				
-	TEXBT35045	TEXBP35045	TEXZT35045	TEXZP35045		45				
-	TEXBT35050	TEXBP35050	TEXZT35050	TEXZP35050	50					
-	-	TEXBP40012	-	TEXZP40012	4	12	COMPLETA	-	-	TX20 / PZ2
-	-	TEXBP40015	-	TEXZP40015		15				
-	TEXBT40016	TEXBP40016	TEXZT40016	TEXZP40016		16				
-	TEXBT40020	TEXBP40020	TEXZT40020	TEXZP40020		20				
-	TEXBT40025	TEXBP40025	TEXZT40025	TEXZP40025		25				
-	TEXBT40030	TEXBP40030	TEXZT40030	TEXZP40030		30				
-	TEXBT40035	TEXBP40035	TEXZT40035	TEXZP40035		35				
-	TEXBT40040	TEXBP40040	TEXZT40040	TEXZP40040		40				
-	TEXBT40045	TEXBP40045	TEXZT40045	TEXZP40045		45				
-	TEXBT40050	TEXBP40050	TEXZT40050	TEXZP40050		50				
-	TEXBT40055	TEXBP40055	TEXZT40055	TEXZP40055	55					
-	TEXBT40060	TEXBP40060	TEXZT40060	TEXZP40060	4,5	60	COMPLETA	-	-	T20 / PZ2
-	TEXBT40070	TEXBP40070	TEXZT40070	TEXZP40070		70				
-	-	TEXBP40080	-	TEXZP40080		80				
-	-	TEXBP45016	-	TEXZP45016		16				
-	-	TEXBP45020	-	TEXZP45020		20				
-	TEXBT45025	TEXBP45025	-	TEXZP45025	25					
-	TEXBT45030	TEXBP45030	TEXZT45030	TEXZP45030	30					
-	TEXBT45035	TEXBP45035	TEXZT45035	TEXZP45035	35					
-	TEXBT45040	TEXBP45040	TEXZT45040	TEXZP45040	40					
-	TEXBT45045	TEXBP45045	-	TEXZP45045	45					
-	TEXBT45050	TEXBP45050	TEXZT45050	TEXZP45050	50					
-	TEXBT45060	TEXBP45060	TEXZT45060	TEXZP45060	4,5	60	COMPLETA	-	-	T20 / PZ2
-	TEXBT45070	TEXBP45070	TEXZT45070	TEXZP45070		70				
-	TEXBT45080	TEXBP45080	TEXZT45080	TEXZP45080		80				

TECBT	TEXBT	TEXBP	TEXZT	TEXZP	Ø	LONGITUD TORNILLO	LONGITUD ROSCA	LIMPIADOR	PUNTA ULTRA AFILADA	HUELLA							
-	-	TEXBP50025	-	TEXZP50025	5	25	COMPLETA	-									
-	TEXBT50030	TEXBP50030	TEXZT50030	TEXZP50030		30											
-	TEXBT50035	TEXBP50035	TEXZT50035	TEXZP50035		35											
-	TEXBT50040	TEXBP50040	TEXZT50040	TEXZP50040		40											
-	TEXBT50045	TEXBP50045	TEXZT50045	TEXZP50045		45											
-	TEXBT50050	TEXBP50050	TEXZT50050	TEXZP50050		50											
-	TEXBT50060	TEXBP50060	TEXZT50060	TEXZP50060		60					30						
-	TEXBT50070	TEXBP50070	TEXZT50070	TEXZP50070		70					40	SI	SI	TX25 / PZ2			
-	TEXBT50080	TEXBP50080	TEXZT50080	TEXZP50080		80											
-	TEXBT50090	TEXBP50090	TEXZT50090	TEXZP50090		90											
-	TEXBT50100	TEXBP50100	TEXZT50100	TEXZP50100		100											
-	-	TEXBP50110	-	TEXZP50110		110									70		
-	TEXBT50120	TEXBP50120	-	TEXZP50120	120												
-	TEXBT60040	TEXBP60040	-	TEXZP60040	40	30	-										
-	TEXBT60045	TEXBP60045	-	TEXZP60045	45												
-	TEXBT60050	TEXBP60050	TEXZT60050	TEXZP60050	50												
-	TEXBT60060	TEXBP60060	TEXZT60060	TEXZP60060	60												
-	TEXBT60070	TEXBP60070	TEXZT60070	TEXZP60070	70					40							
TECBT60080	TEXBT60080	TEXBP60080	TEXZT60080	TEXZP60080	80												
-	TEXBT60090	TEXBP60090	TEXZT60090	TEXZP60090	90												
TECBT60100	TEXBT60100	TEXBP60100	TEXZT60100	TEXZP60100	100												
-	TEXBT60110	TEXBP60110	TEXZT60110	TEXZP60110	110												
TECBT60120	TEXBT60120	TEXBP60120	TEXZT60120	TEXZP60120	120												
-	TEXBT60130	-	TEXZT60130	-	130						70	SI	SI	TX30 / PZ2			
TECBT60140	TEXBT60140	-	TEXZT60140	-	140												
-	TEXBT60150	-	TEXZT60150	-	150												
TECBT60160	TEXBT60160	-	TEXZT60160	-	160												
TECBT60180	TEXBT60180	-	TEXZT60180	-	180												
TECBT60200	TEXBT60200	-	TEXZT60200	-	200												
-	TEXBT60220	-	TEXZT60220	-	220												
-	TEXBT60240	-	TEXZT60240	-	240												
-	TEXBT60260	-	TEXZT60260	-	260												
-	TEXBT60280	-	TEXZT60280	-	280												
-	TEXBT60300	-	TEXZT60300	-	300												
TECBT80080	TEXBT80080	-	-	-	80	40											
TECBT80100	TEXBT80100	-	-	-	100	70											
TECBT80120	TEXBT80120	-	-	-	120												
TECBT80140	TEXBT80140	-	-	-	140												
TECBT80160	TEXBT80160	-	-	-	160												
TECBT80180	TEXBT80180	-	-	-	180												
TECBT80200	TEXBT80200	-	-	-	200												
TECBT80220	TEXBT80220	-	-	-	220												
TECBT80240	TEXBT80240	-	-	-	240	80				SI	SI	TX40					
TECBT80260	TEXBT80260	-	-	-	260												
TECBT80280	TEXBT80280	-	-	-	280												
TECBT80300	TEXBT80300	-	-	-	300												
-	TEXBT80320	-	-	-	320												
-	TEXBT80340	-	-	-	340												
-	TEXBT80360	-	-	-	360												
-	TEXBT80380	-	-	-	380												
-	TEXBT80400	-	-	-	400												
-	TEXBT10080	-	-	-	80		40										
TECBT10100	TEXBT10100	-	-	-	100												
TECBT10120	TEXBT10120	-	-	-	120												
TECBT10140	TEXBT10140	-	-	-	140												
TECBT10160	TEXBT10160	-	-	-	160												
TECBT10180	TEXBT10180	-	-	-	180												
TECBT10200	TEXBT10200	-	-	-	200												
TECBT10220	TEXBT10220	-	-	-	220												
TECBT10240	TEXBT10240	-	-	-	240	80	SI			SI	TX40						
TECBT10260	-	-	-	-	260												
TECBT10280	-	-	-	-	280												
TECBT10300	-	-	-	-	300												
-	-	-	-	-	320												
-	-	-	-	-	340												
-	-	-	-	-	360												
-	-	-	-	-	380												
-	-	-	-	-	400												
-	-	-	-	-	450												

TP-PO B

Bicromatado. Huella PZ



MADERA



CÓDIGO	MEDIDA	€/100		LONGITUD DE LA ROSCA (mm)	UD. MIN. VENTA		
•TPPO25010	2,5 x 10	1,200	PZ1	Total	2.000	1.000	45.000
•TPPO25012	2,5 x 12	1,207	PZ1	Total	2.000	1.000	45.000
•TPPO25016	2,5 x 16	1,350	PZ1	Total	2.000	1.000	45.000
TPPO25020	2,5 x 20	1,527	PZ1	Total	2.000	1.000	24.000
TPPO25025	2,5 x 25	1,643	PZ1	Total	2.000	1.000	24.000
•TPPO30012	3 x 12	1,073	PZ1	Total	2.000	1.000	45.000
•TPPO30016	3 x 16	1,240	PZ1	Total	2.000	1.000	24.000
•TPPO30020	3 x 20	1,393	PZ1	Total	2.000	1.000	24.000
TPPO30025	3 x 25	1,623	PZ1	Total	2.000	1.000	12.000
TPPO30030	3 x 30	1,747	PZ1	Total	2.000	1.000	12.000
TPPO30040	3 x 40	2,300	PZ1	Total	2.000	1.000	6.000
•TPPO35016	3,5 x 16	1,367	PZ2	Total	2.000	1.000	24.000
•TPPO35020	3,5 x 20	1,623	PZ2	Total	2.000	1.000	12.000
TPPO35025	3,5 x 25	1,870	PZ2	Total	2.000	1.000	12.000
TPPO35030	3,5 x 30	2,053	PZ2	Total	2.000	1.000	12.000
TPPO35035	3,5 x 35	2,570	PZ2	Total	1.000	500	6.000
TPPO35040	3,5 x 40	2,793	PZ2	Total	1.000	500	6.000
TPPO35050	3,5 x 50	3,653	PZ2	Total	500	250	3.000
•TPPO40016	4 x 16	1,757	PZ2	Total	2.000	1.000	16.000
•TPPO40020	4 x 20	2,093	PZ2	Total	2.000	1.000	12.000
•TPPO40025	4 x 25	2,333	PZ2	Total	2.000	1.000	12.000
TPPO40030	4 x 30	2,777	PZ2	Total	1.000	500	6.000
TPPO40035	4 x 35	3,067	PZ2	Total	1.000	500	6.000
TPPO40040	4 x 40	3,307	PZ2	Total	1.000	500	6.000
TPPO40045	4 x 45	4,167	PZ2	Total	1.000	500	3.000
TPPO40050	4 x 50	4,557	PZ2	Total	500	250	3.000
TPPO40060	4 x 60	5,277	PZ2	Total	500	250	3.000
TPPO40070	4 x 70	6,500	PZ2	Parcial-52	500	250	3.000
•TPPO45020	4,5 x 20	2,643	PZ2	Total	1.000	500	12.000
•TPPO45025	4,5 x 25	3,140	PZ2	Total	1.000	500	6.000
•TPPO45030	4,5 x 30	3,560	PZ2	Total	1.000	500	6.000
TPPO45035	4,5 x 35	3,873	PZ2	Total	1.000	500	6.000
TPPO45040	4,5 x 40	4,273	PZ2	Total	1.000	500	3.000
TPPO45045	4,5 x 45	5,277	PZ2	Total	500	250	3.000
TPPO45050	4,5 x 50	5,620	PZ2	Total	500	250	3.000
TPPO45060	4,5 x 60	6,620	PZ2	Total	500	250	3.000
TPPO45070	4,5 x 70	8,097	PZ2	Parcial-52	500	250	1.500
TPPO45080	4,5 x 80	10,103	PZ2	Parcial-52	200	100	1.200
•TPPO50020	5 x 20	3,260	PZ2	Total	1.000	500	6.000
•TPPO50025	5 x 25	3,880	PZ2	Total	1.000	500	6.000
•TPPO50030	5 x 30	4,390	PZ2	Total	500	250	6.000
TPPO50035	5 x 35	4,953	PZ2	Total	500	250	3.000
TPPO50040	5 x 40	5,437	PZ2	Total	500	250	3.000
TPPO50045	5 x 45	6,280	PZ2	Total	500	250	3.000
TPPO50050	5 x 50	6,633	PZ2	Total	500	250	3.000
TPPO50060	5 x 60	8,063	PZ2	Total	500	250	1.500
TPPO50070	5 x 70	9,983	PZ2	Parcial-52	200	100	1.200
TPPO50080	5 x 80	11,387	PZ2	Parcial-52	200	100	1.200
TPPO50090	5 x 90	13,527	PZ2	Parcial-60	200	100	1.200
TPPO50100	5 x 100	14,603	PZ2	Parcial-60	200	100	1.200
TPPO50120	5 x 120	22,030	PZ2	Parcial-75	200	100	1.200
•TPPO60040	6 x 40	8,227	PZ3	Total	500	250	3.000
TPPO60050	6 x 50	9,480	PZ3	Total	500	250	1.500
TPPO60060	6 x 60	11,037	PZ3	Total	500	250	1.500
TPPO60070	6 x 70	14,303	PZ3	Parcial-52	200	100	1.200
TPPO60080	6 x 80	16,233	PZ3	Parcial-52	200	100	1.200
TPPO60090	6 x 90	18,483	PZ3	Parcial-60	200	100	1.200
TPPO60100	6 x 100	21,020	PZ3	Parcial-60	100	100	1.200
TPPO60110	6 x 110	24,863	PZ3	Parcial-70	100	100	600
TPPO60120	6 x 120	26,437	PZ3	Parcial-70/75	100	100	600
TPPO60130	6 x 130	31,007	PZ3	Parcial-70/75	100	100	600
TPPO60140	6 x 140	34,893	PZ3	Parcial-70/75	100	100	600
TPPO60150	6 x 150	37,737	PZ3	Parcial-70/75	100	100	600
TPPO60160	6 x 160	42,040	PZ3	Parcial-70/75	100	100	400
TPPO60180	6 x 180	61,490	PZ3	Parcial-70/75	100	100	300
TPPO60200	6 x 200	80,057	PZ3	Parcial-70/75	100	100	300
TPPO60220	6 x 220	115,643	PZ3	Parcial-70/75	100	100	300

• Medidas sin CE



Más gama siguiente página





Tirafondos de cabeza avellanada

TP



Blister

CÓDIGO	MEDIDA	€/BOLSA	PCS.	BOLSAS
BZTPP025016	2,5 x 16	2,029	40	20
BZTPP025020	2,5 x 20	2,029	40	20
BZTPP025025	2,5 x 25	2,029	40	20
BZTPP030016	3 x 16	2,029	40	20
BZTPP030020	3 x 20	2,029	40	20
BZTPP030025	3 x 25	2,029	40	20
BZTPP030030	3 x 30	2,029	40	20
BZTPP035016	3,5 x 16	2,029	40	20
BZTPP035020	3,5 x 20	2,029	40	20
BZTPP035025	3,5 x 25	2,029	40	20
BZTPP035030	3,5 x 30	2,029	40	20
BZTPP035035	3,5 x 35	2,029	20	20
BZTPP035040	3,5 x 40	2,029	20	20
BZTPP035050	3,5 x 50	2,029	20	20
BZTPP040016	4 x 16	2,029	40	20
BZTPP040020	4 x 20	2,029	40	20
BZTPP040025	4 x 25	2,029	40	20
BZTPP040030	4 x 30	2,029	20	20
BZTPP040035	4 x 35	2,029	20	20
BZTPP040040	4 x 40	2,029	20	20
BZTPP040045	4 x 45	2,029	20	20
BZTPP040050	4 x 50	2,029	10	20
BZTPP040060	4 x 60	2,029	10	20
BZTPP045030	4,5 x 30	2,029	20	20
BZTPP045035	4,5 x 35	2,029	20	20
BZTPP045040	4,5 x 40	2,029	20	20
BZTPP045045	4,5 x 45	2,029	10	20
BZTPP045050	4,5 x 50	2,029	10	20
BZTPP045060	4,5 x 60	2,029	10	20
BZTPP045070	4,5 x 70	2,029	10	20
BZTPP050030	5 x 30	2,029	10	20
BZTPP050035	5 x 35	2,029	10	20
BZTPP050040	5 x 40	2,029	10	20
BZTPP050050	5 x 50	2,029	10	20
BZTPP050060	5 x 60	2,029	10	20
BZTPP050070	5 x 70	2,029	4	20
BZTPP050080	5 x 80	2,029	4	20
BZTPP050100	5 x 100	2,029	4	20
BZTPP060040	6 x 40	2,029	10	20
BZTPP060050	6 x 50	2,029	10	20
BZTPP060060	6 x 60	2,029	10	20
BZTPP060070	6 x 70	2,029	4	20
BZTPP060080	6 x 80	2,029	4	20
BZTPP060090	6 x 90	2,029	4	20
BZTPP060100	6 x 100	2,029	4	20



Caja con Ventana

CÓDIGO	MEDIDA	€/CAJA	PCS.	CAJAS
VTTP030016	3 x 16	4,210	250	8
VTTP030020	3 x 20	4,700	250	8
VTTP030025	3 x 25	5,379	250	8
VTTP030030	3 x 30	5,654	250	8
VTTP030040	3 x 40	7,181	250	8
VTTP035016	3,5 x 16	4,527	250	8
VTTP035020	3,5 x 20	5,257	250	8
VTTP035025	3,5 x 25	5,992	250	8
VTTP035030	3,5 x 30	6,424	250	8
VTTP035035	3,5 x 35	5,249	150	8
VTTP035040	3,5 x 40	5,557	150	8
VTTP035050	3,5 x 50	5,021	100	8
VTTP040016	4 x 16	5,870	250	8
VTTP040020	4 x 20	6,854	250	8
VTTP040025	4 x 25	7,572	250	8
VTTP040030	4 x 30	6,078	175	8
VTTP040035	4 x 35	5,877	150	8
VTTP040040	4 x 40	6,449	150	8
VTTP040045	4 x 45	7,875	150	8
VTTP040050	4 x 50	5,926	100	8
VTTP040060	4 x 60	6,913	100	8
VTTP045030	4,5 x 30	6,802	150	8
VTTP045035	4,5 x 35	7,453	150	8
VTTP045040	4,5 x 40	8,016	150	8
VTTP045045	4,5 x 45	6,058	90	8
VTTP045050	4,5 x 50	7,369	100	8
VTTP045060	4,5 x 60	6,761	80	8
VTTP045070	4,5 x 70	6,241	60	8
VTTP050030	5 x 30	5,697	100	8
VTTP050035	5 x 35	6,201	100	8
VTTP050040	5 x 40	6,802	100	8
VTTP050050	5 x 50	8,303	100	8
VTTP050060	5 x 60	8,234	80	8
VTTP050070	5 x 70	4,581	35	8
VTTP050080	5 x 80	4,477	30	8
VTTP050090	5 x 90	5,207	30	8
VTTP060040	6 x 40	10,290	100	8
VTTP060050	6 x 50	9,488	80	8
VTTP060060	6 x 60	8,451	60	8
VTTP060070	6 x 70	5,425	30	8
VTTP060080	6 x 80	5,903	30	8

TP-PO B

Bicromatado. Huella PZ



Más gama página anterior

TP-PO Z

Cincado. Huella PZ



Disponible en varios recubrimientos. Consulte precio y plazo de entrega.



CÓDIGO	MEDIDA	€/100		LONGITUD DE LA ROSCA (mm)	UD. MIN. VENTA		
•TPPOZ25010	2,5 x 10	1,200	PZ1	Total	2.000	1.000	45.000
•TPPOZ25012	2,5 x 12	1,207	PZ1	Total	2.000	1.000	45.000
•TPPOZ25016	2,5 x 16	1,350	PZ1	Total	2.000	1.000	45.000
TPPOZ25020	2,5 x 20	1,527	PZ1	Total	2.000	1.000	24.000
TPPOZ25025	2,5 x 25	1,643	PZ1	Total	2.000	1.000	24.000
•TPPOZ30012	3 x 12	1,073	PZ1	Total	2.000	1.000	45.000
•TPPOZ30016	3 x 16	1,240	PZ1	Total	2.000	1.000	24.000
•TPPOZ30020	3 x 20	1,393	PZ1	Total	2.000	1.000	24.000
TPPOZ30025	3 x 25	1,623	PZ1	Total	2.000	1.000	12.000
TPPOZ30030	3 x 30	1,747	PZ1	Total	2.000	1.000	12.000
TPPOZ30040	3 x 40	2,300	PZ1	Total	2.000	1.000	6.000
•TPPOZ35016	3,5 x 16	1,367	PZ2	Total	2.000	1.000	24.000
•TPPOZ35020	3,5 x 20	1,623	PZ2	Total	2.000	1.000	12.000
TPPOZ35025	3,5 x 25	1,870	PZ2	Total	2.000	1.000	12.000
TPPOZ35030	3,5 x 30	2,053	PZ2	Total	2.000	1.000	12.000
TPPOZ35035	3,5 x 35	2,570	PZ2	Total	1.000	500	6.000
TPPOZ35040	3,5 x 40	2,793	PZ2	Total	1.000	500	6.000
TPPOZ35050	3,5 x 50	3,653	PZ2	Total	500	250	3.000
•TPPOZ40016	4 x 16	1,757	PZ2	Total	2.000	1.000	16.000
•TPPOZ40020	4 x 20	2,093	PZ2	Total	2.000	1.000	12.000
•TPPOZ40025	4 x 25	2,333	PZ2	Total	2.000	1.000	12.000
TPPOZ40030	4 x 30	2,777	PZ2	Total	1.000	500	6.000
TPPOZ40035	4 x 35	3,067	PZ2	Total	1.000	500	6.000
TPPOZ40040	4 x 40	3,307	PZ2	Total	1.000	500	6.000
TPPOZ40045	4 x 45	4,167	PZ2	Total	1.000	500	3.000
TPPOZ40050	4 x 50	4,557	PZ2	Total	500	250	3.000
TPPOZ40060	4 x 60	5,277	PZ2	Total	500	250	3.000
TPPOZ40070	4 x 70	6,500	PZ2	Parcial-52	500	250	1.500
•TPPOZ45020	4,5 x 20	2,643	PZ2	Total	1.000	500	12.000
•TPPOZ45025	4,5 x 25	3,140	PZ2	Total	1.000	500	6.000
•TPPOZ45030	4,5 x 30	3,560	PZ2	Total	1.000	500	6.000
TPPOZ45035	4,5 x 35	3,873	PZ2	Total	1.000	500	6.000
TPPOZ45040	4,5 x 40	4,273	PZ2	Total	1.000	500	3.000
TPPOZ45045	4,5 x 45	5,277	PZ2	Total	500	250	3.000
TPPOZ45050	4,5 x 50	5,620	PZ2	Total	500	250	3.000
TPPOZ45060	4,5 x 60	6,620	PZ2	Total	500	250	3.000
TPPOZ45070	4,5 x 70	8,097	PZ2	Parcial-52	500	250	1.500
TPPOZ45080	4,5 x 80	10,103	PZ2	Parcial-52	200	100	1.200
•TPPOZ50020	5 x 20	3,260	PZ2	Total	1.000	500	6.000
•TPPOZ50025	5 x 25	3,880	PZ2	Total	1.000	500	6.000
•TPPOZ50030	5 x 30	4,390	PZ2	Total	500	250	6.000
TPPOZ50035	5 x 35	4,953	PZ2	Total	500	250	3.000
TPPOZ50040	5 x 40	5,437	PZ2	Total	500	250	3.000
TPPOZ50045	5 x 45	6,280	PZ2	Total	500	250	3.000
TPPOZ50050	5 x 50	6,633	PZ2	Total	500	250	3.000
TPPOZ50060	5 x 60	8,063	PZ2	Total	500	250	1.500
TPPOZ50070	5 x 70	9,983	PZ2	Parcial-52	200	100	1.200
TPPOZ50080	5 x 80	11,387	PZ2	Parcial-52	200	100	1.200
TPPOZ50090	5 x 90	13,527	PZ2	Parcial-60	200	100	1.200
TPPOZ50100	5 x 100	14,603	PZ2	Parcial-60	200	100	1.200
TPPOZ50120	5 x 120	22,030	PZ2	Parcial-75	200	100	1.200
•TPPOZ60040	6 x 40	8,227	PZ3	Total	500	250	3.000
TPPOZ60050	6 x 50	9,480	PZ3	Total	500	250	1.500
TPPOZ60060	6 x 60	11,037	PZ3	Total	500	250	1.500
TPPOZ60070	6 x 70	14,303	PZ3	Parcial-52	200	100	1.200
TPPOZ60080	6 x 80	16,233	PZ3	Parcial-52	200	100	1.200
TPPOZ60090	6 x 90	18,483	PZ3	Parcial-60	200	100	1.200
TPPOZ60100	6 x 100	21,020	PZ3	Parcial-60	100	100	1.200
TPPOZ60110	6 x 110	24,863	PZ3	Parcial-70	100	100	600

• Medidas sin CE



Más gama siguiente página





Caja con Ventana

CÓDIGO	MEDIDA	€/CAJA	PCS.	CAJAS
VTPOZ30025	3 x 25	5,379	250	8
VTPOZ30030	3 x 30	5,654	250	8
VTPOZ35016	3,5 x 16	4,527	250	8
VTPOZ35020	3,5 x 20	5,257	250	8
VTPOZ35025	3,5 x 25	5,992	250	8
VTPOZ35030	3,5 x 30	6,424	250	8
VTPOZ35035	3,5 x 35	5,249	150	8
VTPOZ35040	3,5 x 40	5,557	150	8
VTPOZ35050	3,5 x 50	5,021	100	8
VTPOZ40016	4 x 16	5,870	250	8
VTPOZ40020	4 x 20	6,854	250	8
VTPOZ40025	4 x 25	7,572	250	8
VTPOZ40030	4 x 30	6,078	175	8
VTPOZ40035	4 x 35	5,877	150	8
VTPOZ40040	4 x 40	6,449	150	8
VTPOZ40045	4 x 45	7,875	150	8
VTPOZ40050	4 x 50	5,926	100	8
VTPOZ40060	4 x 60	6,913	100	8
VTPOZ45030	4,5 x 30	6,802	150	8
VTPOZ45035	4,5 x 35	7,453	150	8
VTPOZ45040	4,5 x 40	8,231	150	8
VTPOZ45045	4,5 x 45	6,058	90	8
VTPOZ45050	4,5 x 50	7,369	100	8
VTPOZ45060	4,5 x 60	6,761	80	8
VTPOZ45070	4,5 x 70	6,241	60	8
VTPOZ50030	5 x 30	5,697	100	8
VTPOZ50035	5 x 35	6,201	100	8
VTPOZ50040	5 x 40	6,802	100	8
VTPOZ50050	5 x 50	8,303	100	8
VTPOZ50060	5 x 60	8,234	80	8
VTPOZ50070	5 x 70	4,581	35	8
VTPOZ50080	5 x 80	4,477	30	8
VTPOZ50090	5 x 90	5,207	30	8
VTPOZ60060	6 x 60	8,451	60	8
VTPOZ60070	6 x 70	5,425	30	8
VTPOZ60080	6 x 80	5,903	30	8

TP-PO Z

Cincado. Huella PZ



Disponible en varios
recubrimientos.
Consulte precio y plazo de entrega.



Más gama página
anterior

TP-TO

Bicromatado. Huella TX



Disponible en varios recubrimientos. Consulte precio y plazo de entrega.



CÓDIGO	MEDIDA	€/100		UD. MIN. VENTA		
TPTO30025	3 x 25	2,023	TX10	2.000	1.000	12.000
TPTO30030	3 x 30	2,337	TX10	2.000	1.000	12.000
•TPTO35015	3,5 x 15	1,717	TX15	2.000	1.000	24.000
•TPTO35017	3,5 x 17	1,790	TX15	2.000	1.000	24.000
•TPTO35020	3,5 x 20	2,080	TX15	2.000	1.000	12.000
TPTO35025	3,5 x 25	2,450	TX15	2.000	1.000	12.000
TPTO35030	3,5 x 30	2,673	TX15	2.000	1.000	12.000
TPTO35040	3,5 x 40	3,700	TX15	1.000	500	6.000
TPTO35050	3,5 x 50	4,497	TX15	1.000	500	3.000
•TPTO40020	4 x 20	2,793	TX20	2.000	1.000	12.000
•TPTO40025	4 x 25	3,230	TX20	2.000	1.000	12.000
TPTO40030	4 x 30	3,873	TX20	1.000	500	6.000
TPTO40035	4 x 35	4,407	TX20	1.000	500	6.000
TPTO40040	4 x 40	4,770	TX20	1.000	500	6.000
TPTO40045	4 x 45	5,367	TX20	1.000	500	6.000
TPTO40050	4 x 50	6,127	TX20	500	250	3.000
TPTO40060	4 x 60	6,437	TX20	500	250	3.000
TPTO40070	4 x 70	8,430	TX20	500	250	1.500
•TPTO45030	4,5 x 30	4,670	TX20	1.000	500	6.000
TPTO45035	4,5 x 35	5,057	TX20	1.000	500	6.000
TPTO45040	4,5 x 40	5,837	TX20	1.000	500	6.000
TPTO45045	4,5 x 45	6,843	TX20	500	250	3.000
TPTO45050	4,5 x 50	7,687	TX20	500	250	3.000
TPTO45060	4,5 x 60	8,827	TX20	500	250	3.000
TPTO45070	4,5 x 70	10,370	TX20	500	250	1.500

CÓDIGO	MEDIDA	€/100		UD. MIN. VENTA		
•TPTO50030	5 x 30	6,013	TX25	500	250	6.000
•TPTO50035	5 x 35	6,563	TX25	500	250	6.000
TPTO50040	5 x 40	7,367	TX25	500	250	3.000
TPTO50045	5 x 45	8,347	TX25	500	250	3.000
TPTO50050	5 x 50	8,937	TX25	500	250	3.000
TPTO50060	5 x 60	10,253	TX25	500	250	1.500
TPTO50070	5 x 70	13,353	TX25	200	100	1.200
TPTO50080	5 x 80	15,430	TX25	200	100	1.200
TPTO50090	5 x 90	16,857	TX25	200	100	1.200
TPTO50100	5 x 100	18,293	TX25	200	100	1.200
TPTO50120	5 x 120	25,327	TX25	200	100	1.200
TPTO60060	6 x 60	14,270	TX30	500	250	1.500
TPTO60070	6 x 70	17,063	TX30	200	100	1.200
TPTO60080	6 x 80	21,030	TX30	200	100	1.200
TPTO60090	6 x 90	25,750	TX30	200	100	1.200
TPTO60100	6 x 100	27,713	TX30	100	100	1.200
TPTO60110	6 x 110	32,307	TX30	100	100	600
TPTO60120	6 x 120	34,743	TX30	100	100	600
TPTO60130	6 x 130	41,410	TX30	100	100	600
TPTO60140	6 x 140	45,943	TX30	100	100	600
TPTO60150	6 x 150	52,863	TX30	100	100	600
TPTO60160	6 x 160	58,533	TX30	100	100	400
TPTO60180	6 x 180	78,437	TX30	100	100	300
TPTO60200	6 x 200	94,157	TX30	100	100	300
TPTO60220	6 x 220	125,810	TX30	100	100	300

• Medidas sin CE



Caja con Ventana

CÓDIGO	MEDIDA	€/CAJA	PCS.	CAJAS
VTPTO30025	3 x 25	5,934	250	8
VTPTO30030	3 x 30	6,758	250	8
VTPTO35015	3,5 x 15	5,375	250	8
VTPTO35020	3,5 x 20	6,423	250	8
VTPTO35025	3,5 x 25	7,226	250	8
VTPTO35030	3,5 x 30	8,048	250	8
VTPTO35040	3,5 x 40	6,679	150	8
VTPTO35050	3,5 x 50	5,730	100	8
VTPTO40020	4 x 20	8,410	250	8
VTPTO40025	4 x 25	10,004	250	8
VTPTO40030	4 x 30	8,366	175	8
VTPTO40035	4 x 35	7,970	150	8
VTPTO40040	4 x 40	8,616	150	8
VTPTO40045	4 x 45	9,690	150	8
VTPTO40050	4 x 50	7,584	100	8
VTPTO40060	4 x 60	7,964	100	8
VTPTO45030	4,5 x 30	8,279	150	8

CÓDIGO	MEDIDA	€/CAJA	PCS.	CAJAS
VTPTO45035	4,5 x 35	9,142	150	8
VTPTO45040	4,5 x 40	10,557	150	8
VTPTO45045	4,5 x 45	7,420	90	8
VTPTO45050	4,5 x 50	9,253	100	8
VTPTO45060	4,5 x 60	8,501	80	8
VTPTO45070	4,5 x 70	7,493	60	8
VTPTO50030	5 x 30	7,247	100	8
VTPTO50035	5 x 35	8,108	100	8
VTPTO50040	5 x 40	9,542	100	8
VTPTO50050	5 x 50	10,771	100	8
VTPTO50060	5 x 60	9,879	80	8
VTPTO50070	5 x 70	5,781	35	8
VTPTO50080	5 x 80	5,722	30	8
VTPTO50090	5 x 90	6,254	30	8
VTPTO60060	6 x 60	10,314	60	8
VTPTO60070	6 x 70	6,330	30	8
VTPTO60080	6 x 80	7,804	30	8



Tirafondos de cabeza avellanada

TP

INOXIDABLE



TP-A2

Inoxidable A2. Huella PZ

CÓDIGO	MEDIDA	€/100			
TPA230016	3 x 16	5,697	PZ1	200	9.000
TPA230025	3 x 25	7,283	PZ1	200	9.000
TPA235020	3,5 x 20	9,610	PZ2	200	9.000
TPA235025	3,5 x 25	10,380	PZ2	200	9.000
TPA235030	3,5 x 30	12,937	PZ2	200	9.000
TPA235040	3,5 x 40	18,390	PZ2	200	4.800
TPA240030	4 x 30	15,720	PZ2	200	9.000
TPA240040	4 x 40	18,563	PZ2	200	4.800
TPA240050	4 x 50	29,137	PZ2	200	4.800
TPA245030	4,5 x 30	18,463	PZ2	200	4.800
TPA245050	4,5 x 50	29,487	PZ2	200	2.400
TPA250050	5 x 50	37,190	PZ2	200	2.400
TPA250070	5 x 70	50,683	PZ2	200	2.400



Tirafondo de cabeza alomada, bicromatado. Huella PZ

TR-PO

MADERA



CÓDIGO	MEDIDA	€/100			
TRPO30016	3 x 16	2,157	PZ1	1.000	24.000
TRPO30020	3 x 20	2,433	PZ1	1.000	12.000
TRPO35016	3,5 x 16	2,837	PZ2	1.000	24.000
TRPO35020	3,5 x 20	3,277	PZ2	1.000	12.000
TRPO35025	3,5 x 25	3,517	PZ2	1.000	12.000
TRPO35030	3,5 x 30	3,880	PZ2	1.000	12.000
TRPO35035	3,5 x 35	4,073	PZ2	500	6.000
TRPO40016	4 x 16	3,597	PZ2	1.000	12.000
TRPO40020	4 x 20	3,763	PZ2	1.000	12.000
TRPO40025	4 x 25	4,317	PZ2	1.000	12.000
TRPO40030	4 x 30	4,853	PZ2	500	6.000
TRPO40035	4 x 35	5,170	PZ2	500	6.000
TRPO40040	4 x 40	5,967	PZ2	500	6.000
TRPO40050	4 x 50	7,740	PZ2	250	3.000
TRPO45016	4,5 x 16	4,407	PZ2	500	12.000
TRPO45020	4,5 x 20	4,950	PZ2	500	8.000
TRPO45025	4,5 x 25	5,857	PZ2	500	6.000
TRPO45030	4,5 x 30	6,567	PZ2	500	6.000
TRPO45035	4,5 x 35	7,583	PZ2	500	6.000
TRPO45040	4,5 x 40	7,910	PZ2	500	3.000
TRPO45045	4,5 x 45	8,760	PZ2	250	3.000
TRPO50020	5 x 20	6,620	PZ2	500	6.000
TRPO50030	5 x 30	7,697	PZ2	250	6.000
TRPO50040	5 x 40	8,983	PZ2	250	3.000
TRPO50050	5 x 50	11,343	PZ2	250	3.000



DIN-571

Tornillo con rosca para madera y aglomerado. Cabeza hexagonal

DIN-571

Cincado



Disponible en varios recubrimientos. Consulte precio y plazo de entrega.

CÓDIGO	MEDIDA	€/100			
•TB05030	5 x 30	6,720	8	200	4.800
•TB05040	5 x 40	8,530	8	200	2.400
TB05050	5 x 50	10,030	8	200	2.400
TB05060	5 x 60	11,327	8	200	2.400
•TB06025	6 x 25	7,600	10	200	2.400
•TB06030	6 x 30	8,433	10	200	2.400
•TB06035	6 x 35	9,670	10	200	2.400
•TB06040	6 x 40	10,397	10	200	2.400
•TB06045	6 x 45	11,380	10	200	2.400
•TB06050	6 x 50	12,437	10	200	2.400
TB06060	6 x 60	14,663	10	200	1.200
TB06070	6 x 70	16,873	10	200	1.200
TB06080	6 x 80	18,483	10	200	1.200
TB06090	6 x 90	21,770	10	100	1.200
TB06100	6 x 100	22,817	10	100	1.200
TB06110	6 x 110	30,067	10	100	1.200
TB06120	6 x 120	30,153	10	100	800
TB07030	7 x 30	13,697	12	200	2.400
TB07040	7 x 40	16,697	12	200	1.600
TB07050	7 x 50	19,387	12	200	1.200
TB07060	7 x 60	22,610	12	100	1.200
TB07070	7 x 70	25,087	12	100	1.200
TB07080	7 x 80	27,650	12	100	800
TB07090	7 x 90	28,117	12	100	400
TB07100	7 x 100	31,787	12	100	600
TB07120	7 x 120	38,867	12	100	600
•TB08030	8 x 30	16,210	13	200	1.200
•TB08040	8 x 40	19,197	13	200	1.200
•TB08045	8 x 45	20,143	13	200	1.200
•TB08050	8 x 50	22,090	13	200	1.200
•TB08060	8 x 60	25,217	13	200	1.200
•TB08070	8 x 70	28,673	13	200	800
TB08080	8 x 80	32,000	13	200	800
TB08090	8 x 90	37,473	13	100	600
TB08100	8 x 100	40,527	13	100	600
TB08110	8 x 110	41,737	13	100	600
TB08120	8 x 120	45,663	13	100	600

CÓDIGO	MEDIDA	€/100			
TB08130	8 x 130	50,390	13	100	400
TB08140	8 x 140	53,473	13	100	400
TB08150	8 x 150	56,310	13	100	400
TB08160	8 x 160	59,410	13	100	400
TB08180	8 x 180	77,313	13	100	300
TB08200	8 x 200	81,197	13	100	300
•TB10040	10 x 40	37,520	17	100	600
•TB10050	10 x 50	39,037	17	100	600
•TB10060	10 x 60	42,573	17	100	600
•TB10070	10 x 70	50,187	17	100	600
•TB10080	10 x 80	54,060	17	100	400
•TB10090	10 x 90	62,637	17	100	400
•TB10100	10 x 100	64,997	17	100	400
TB10110	10 x 110	71,117	17	50	300
TB10120	10 x 120	78,393	17	50	300
TB10130	10 x 130	82,587	17	50	300
TB10140	10 x 140	98,573	17	50	200
TB10150	10 x 150	105,483	17	50	200
TB10160	10 x 160	112,597	17	50	200
TB10180	10 x 180	123,410	17	50	150
TB10200	10 x 200	135,750	17	50	150
•TB12060	12 x 60	69,660	19	50	300
•TB12070	12 x 70	73,457	19	50	300
•TB12080	12 x 80	83,560	19	50	300
•TB12090	12 x 90	89,047	19	50	300
•TB12100	12 x 100	98,993	19	50	300
TB12120	12 x 120	120,343	19	50	200
TB12130	12 x 130	129,273	19	50	100
TB12140	12 x 140	139,093	19	50	100
TB12150	12 x 150	144,037	19	50	200
TB12160	12 x 160	153,910	19	50	200
TB12180	12 x 180	184,467	19	50	150
TB12200	12 x 200	210,097	19	50	150
TB12220	12 x 220	229,183	19	50	100
TB12240	12 x 240	245,810	19	50	100
TB12260	12 x 260	269,473	19	50	100
•TB14100	14 x 100	176,977	22	50	200

• Medidas sin CE



Blister

CÓDIGO	MEDIDA	€/BOLSA	PCS.	BOLSAS
BZTB05030	5 x 30	2,029	4	20
BZTB05040	5 x 40	2,029	4	20
BZTB05050	5 x 50	2,029	4	20
BZTB06030	6 x 30	2,029	4	20
BZTB06040	6 x 40	2,029	4	20
BZTB06050	6 x 50	2,029	4	20
BZTB06060	6 x 60	2,029	4	20
BZTB06070	6 x 70	2,029	4	20
BZTB06080	6 x 80	2,029	4	20
BZTB07050	7 x 50	2,029	4	20
BZTB07060	7 x 60	2,029	4	20
BZTB07070	7 x 70	2,029	4	20
BZTB08040	8 x 40	2,029	4	20
BZTB08050	8 x 50	2,029	4	20
BZTB08060	8 x 60	2,029	4	20
BZTB08070	8 x 70	2,029	4	20
BZTB08080	8 x 80	2,029	4	15
BZTB08090	8 x 90	2,029	2	15
BZTB08100	8 x 100	2,029	2	15
BZTB10050	10 x 50	2,029	2	15
BZTB10060	10 x 60	2,029	2	15
BZTB10080	10 x 80	2,029	2	15



Caja con Ventana

CÓDIGO	MEDIDA	€/CAJA	PCS.	CAJAS
VTB05040	5 x 40	5,198	50	8
VTB05050	5 x 50	6,108	50	8
VTB06040	6 x 40	6,469	50	8
VTB06050	6 x 50	6,068	40	8
VTB06060	6 x 60	5,315	30	8
VTB07050	7 x 50	5,820	25	8
VTB07060	7 x 60	5,541	20	8
VTB07070	7 x 70	5,991	20	8
VTB07080	7 x 80	6,320	20	8
VTB08050	8 x 50	5,441	20	8
VTB08060	8 x 60	6,217	20	8
VTB08070	8 x 70	7,064	20	8
VTB08080	8 x 80	5,910	15	8
VTB08090	8 x 90	4,503	10	8
VTB08100	8 x 100	4,846	10	8
VTB10070	10 x 70	6,086	10	8
VTB10080	10 x 80	6,455	10	8
VTB10090	10 x 90	7,483	10	8
VTB10100	10 x 100	7,880	10	8

Tornillo con rosca para madera y aglomerado. Cabeza hexagonal

DIN-571

INOXIDABLE



CÓDIGO	MEDIDA	€/100			
•TBA206040	6 x 40	36,067	10	100	2.400
•TBA206050	6 x 50	42,910	10	100	1.200
TBA206060	6 x 60	48,797	10	100	1.200
TBA206070	6 x 70	55,167	10	100	1.200
•TBA208050	8 x 50	80,037	13	100	1.200
•TBA208060	8 x 60	88,080	13	100	1.200
•TBA208070	8 x 70	99,517	13	100	600
TBA208080	8 x 80	111,423	13	100	600
•TBA210080	10 x 80	188,553	17	100	400

• Medidas sin CE

DIN-571 A2

Inoxidable A2



MADERA



CÓDIGO	MEDIDA	€/100			
TBR06050	6 x 50	12,840	10	200	1.200
TBR06060	6 x 60	15,127	10	200	1.200
TBR06070	6 x 70	17,403	10	200	1.200
TBR08050	8 x 50	22,780	13	200	1.200
TBR08060	8 x 60	26,010	13	200	800
TBR08070	8 x 70	29,570	13	200	800
TBR08080	8 x 80	33,000	13	200	800
TBR10060	10 x 60	43,903	17	100	600
TBR10080	10 x 80	55,753	17	100	400

571 TR

Con rosca completa



Tornillo inviolable. Huella TX

INV

MADERA



CÓDIGO	MEDIDA	€/100		UD. MIN. VENTA		
•INVZ6040	6 x 40	28,723	TX40	200	100	1.200
INVZ6050	6 x 50	30,390	TX40	200	100	1.200
INVZ6060	6 x 60	32,330	TX40	200	100	600
INVZ6070	6 x 70	38,440	TX40	200	100	600
•INVZ7030	7 x 30	26,620	TX40	200	100	1.200
•INVZ7040	7 x 40	27,137	TX40	200	100	1.200
INVZ7050	7 x 50	27,483	TX40	200	100	1.200
INVZ7060	7 x 60	31,437	TX40	200	100	600
INVZ7070	7 x 70	33,312	TX40	200	100	600
INVZ7080	7 x 80	38,417	TX40	200	100	600
INVZ7090	7 x 90	44,133	TX40	200	100	600

• Medidas sin CE

INV Z

Cincado



Disponible en varios recubrimientos. Consulte precio y plazo de entrega.



Blister



Caja con Ventana

CÓDIGO	MEDIDA	€/BOLSA	PCS.	BOLSAS
BZINVZ7060	7 x 60	2,565	4	20
BZINVZ7070	7 x 70	2,565	4	20
BZINVZ7080	7 x 80	2,565	4	15

CÓDIGO	MEDIDA	€/CAJA	PCS.	CAJAS
VINVZ7060	7 x 60	6,250	15	8
VINVZ7070	7 x 70	6,399	15	8

INV

Tornillo inviolable. Huella TX

INV A2

Inoxidable A2



INOXIDABLE



CÓDIGO	MEDIDA	€/100			
•INVA27050	7 x 50	102,340	TX40	100	1.200
•INVA27060	7 x 60	118,637	TX40	100	600
INVA27070	7 x 70	121,547	TX40	100	600
INVA27080	7 x 80	134,197	TX40	100	600

• Medidas sin CE

INV N

Cincado negro



MADERA



CÓDIGO	MEDIDA	€/100			
•INVN6040	6 x 40	33,967	TX40	100	1.200
INVN6050	6 x 50	35,057	TX40	100	1.200
INVN6060	6 x 60	38,830	TX40	100	600
INVN6070	6 x 70	42,600	TX40	100	600
•INVN7030	7 x 30	38,423	TX40	100	1.200
•INVN7040	7 x 40	40,077	TX40	100	1.200
INVN7050	7 x 50	44,137	TX40	100	1.200
INVN7060	7 x 60	48,960	TX40	100	600
INVN7070	7 x 70	51,743	TX40	100	600
INVN7080	7 x 80	56,817	TX40	100	600
INVN7090	7 x 90	60,880	TX40	100	600

• Medidas sin CE



Blister

CÓDIGO	MEDIDA	€/BOLSA	PCS.	BOLSAS
BZINVN7060	7 x 60	2,565	4	20
BZINVN7070	7 x 70	2,565	4	20
BZINVN7080	7 x 80	2,565	2	15



Caja con Ventana

CÓDIGO	MEDIDA	€/CAJA	PCS.	CAJAS
VINVN7060	7 x 60	9,971	15	8
VINVN7070	7 x 70	10,528	15	8

ESTRINV Z

Estrella inviolable. Cincada



MADERA



CÓDIGO	MEDIDA	€/100	UD. MIN. VENTA	
ESTRINV40Z	ZINC	5,257	400	100

ESTRINV N

Estrella inviolable. Negra



MADERA



CÓDIGO	MEDIDA	€/100	UD. MIN. VENTA	
ESTRINV40N	NEGRA	6,163	400	100



Tornillo de ensamblar

TRE



CÓDIGO	MEDIDA	€/100		
TREZ05050	Ø5 x 50	7,957	300	1.800
TREZ07050	Ø7 x 50	13,287	200	2.400



Blister



Caja con Ventana

CÓDIGO	MEDIDA	€/BOLSA	PCS.	BOLSAS
BZTREZ05050	Ø5 x 50	2,029	4	20
BZTREZ07050	Ø7 x 50	2,029	4	20

CÓDIGO	MEDIDA	€/CAJA	PCS.	CAJAS
VTREZ05050	Ø5 x 50	5,302	50	8
VTREZ07050	Ø7 x 50	5,100	30	8

TRE-Z

Cincado



CÓDIGO	MEDIDA	€/100		
TREPV05050	Ø5 x 50	9,093	300	1.800
TREPV07050	Ø7 x 50	13,287	200	2.400



Blister



Caja con Ventana

CÓDIGO	MEDIDA	€/BOLSA	PCS.	BOLSAS
BZTREP05050	Ø5 x 50	2,029	4	20
BZTREP07050	Ø7 x 50	2,029	4	20

CÓDIGO	MEDIDA	€/CAJA	PCS.	CAJAS
VTREP05050	Ø5 x 50	5,912	50	8
VTREP07050	Ø7 x 50	5,302	30	8

TRE-PV

Pavonado



Tornillo cubierta metal madera

FS



CÓDIGO	MEDIDA	€/100			
AFZN144819	4,8 x 19 P14	14,990	8	250	3.000
AFZN144828	4,8 x 28 P14	17,607	8	250	3.000
AFZN144835	4,8 x 35 P14	18,377	8	250	3.000

FS Z

Cincado



CÓDIGO	MEDIDA	€/100			
AFRT144819	4,8 x 19 P14 3.009	18,290	8	250	3.000
AFRT144828	4,8 x 28 P14 3.009	20,297	8	250	3.000
AFRT144835	4,8 x 35 P14 3.009	24,253	8	250	3.000

FS 3009

RAL 3009. Rojo teja



CÓDIGO	MEDIDA	€/100			
AFRD144819	4,8 x 19 P14 3.011	18,290	8	250	3.000
AFRD144828	4,8 x 28 P14 3.011	20,297	8	250	3.000
AFRD144835	4,8 x 35 P14 3.011	24,253	8	250	3.000

FS 3011

RAL 3011. Rojo pardo



FS

Tornillo cubierta metal madera

FS 5010

RAL 5010. Azul genciana



CÓDIGO	MEDIDA	€/100			
• AFAZ144819	4,8 x 19 P14 5.010	18,290	8	250	3.000
• AFAZ144828	4,8 x 28 P14 5.010	20,297	8	250	3.000
• AFAZ144835	4,8 x 35 P14 5.010	24,253	8	250	3.000

• Hasta fin de existencias

FS 6005

RAL 6005. Verde musgo



CÓDIGO	MEDIDA	€/100			
AFVE144819	4,8 x 19 P14 6.005	18,290	8	250	3.000
AFVE144828	4,8 x 28 P14 6.005	20,297	8	250	3.000
AFVE144835	4,8 x 35 P14 6.005	24,253	8	250	3.000

FS 8004

RAL 8004. Marrón cobre



CÓDIGO	MEDIDA	€/100			
AFMC144819	4,8 x 19 P14 8.004	18,290	8	250	3.000
AFMC144828	4,8 x 28 P14 8.004	20,297	8	250	3.000
AFMC144835	4,8 x 35 P14 8.004	24,253	8	250	3.000

FS 8017

RAL 8017. Marrón chocolate



CÓDIGO	MEDIDA	€/100			
AFMD144819	4,8 x 19 P14 8.017	18,290	8	250	3.000
AFMD144828	4,8 x 28 P14 8.017	20,297	8	250	3.000
AFMD144835	4,8 x 35 P14 8.017	24,253	8	250	3.000

FS 8019

RAL 8019. Gris pardo



CÓDIGO	MEDIDA	€/100			
AFPG144819	4,8 x 19 P14 8.019	18,290	8	250	3.000
AFPG144828	4,8 x 28 P14 8.019	20,297	8	250	3.000
AFPG144835	4,8 x 35 P14 8.019	24,253	8	250	3.000



Tornillo cubierta metal madera

FS



CÓDIGO	MEDIDA	€/100			
AFGR144819	4,8 x 19 P14 9.006	18,290	8	250	3.000
AFGR144828	4,8 x 28 P14 9.006	20,297	8	250	3.000
AFGR144835	4,8 x 35 P14 9.006	24,253	8	250	3.000

FS 9006

RAL 9006. Gris aluminio



CÓDIGO	MEDIDA	€/100			
AFBL144819	4,8 x 19 P14 9.010	18,290	8	250	3.000
AFBL144828	4,8 x 28 P14 9.010	20,297	8	250	3.000
AFBL144835	4,8 x 35 P14 9.010	24,253	8	250	3.000

FS 9010

RAL 9010. Blanco

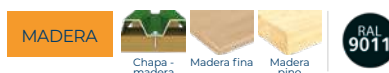

CÓDIGO	MEDIDA	€/100			
AFNE144819	4,8 x 19 P14 9.011	18,290	8	250	3.000
AFNE144828	4,8 x 28 P14 9.011	20,297	8	250	3.000
AFNE144835	4,8 x 35 P14 9.011	24,253	8	250	3.000

FS 9011

RAL 9011. Negro



Tornillo de cabeza cilíndrica especial extraplana con rosca de doble hilo para aluminio. Cincado y huella TX

FIMA



CÓDIGO	MEDIDA	€/100			
TFI4825	4,8 x 25	6,463	TX20	500	6.000
TFI4835	4,8 x 35	7,687	TX20	500	6.000
TFI4845	4,8 x 45	9,890	TX20	500	3.000
TFI4855	4,8 x 55	11,577	TX20	500	3.000
TFI4865	4,8 x 65	13,757	TX20	250	1.500
TFI4875	4,8 x 75	16,463	TX20	250	1.500
TFI4890	4,8 x 90	24,643	TX20	250	1.500



A
ERFEC
FIXIN
NDI



PUNTAS, ALCAYATAS Y HEMBRILLAS



AL-RE

Alcayata redonda



MULTIMATERIAL



CÓDIGO	MEDIDA	€/100		
ALRE20015	2 x 15 x 7	0,759	500	22.500
ALRE25020	2,5 x 20 x 12	1,645	500	22.500
ALRE25025	2,5 x 25 x 12	1,802	500	12.000
ALRE25030	2,5 x 30 x 12	2,342	300	7.200
ALRE35040	3,5 x 40 x 14	5,777	300	7.200
ALRE35050	3,5 x 50 x 14	6,080	300	3.600
ALRE40060	4 x 60 x 16	8,357	200	2.400
ALRE40070	4 x 70 x 16	10,519	200	1.200
ALRE40080	4 x 80 x 16	11,753	100	1.200



Blister

CÓDIGO	MEDIDA	€/BOLSA	PCS. 	BOLSAS
BZALRE20015	2 x 15 x 7	2,029	25	20
BZALRE25020	2,5 x 20 x 12	2,029	25	20
BZALRE25025	2,5 x 25 x 12	2,029	25	20
BZALRE25030	2,5 x 30 x 12	2,029	15	20
BZALRE35040	3,5 x 40 x 14	2,029	15	20
BZALRE35050	3,5 x 50 x 14	2,029	15	20
BZALRE40060	4 x 60 x 16	2,029	10	20
BZALRE40070	4 x 70 x 16	2,029	6	20
BZALRE40080	4 x 80 x 16	2,029	4	20



Caja con Ventana

CÓDIGO	MEDIDA	€/CAJA	PCS. 	CAJAS
VALRE25020	2,5 x 20 x 12	3,113	125	8
VALRE25030	2,5 x 25 x 12	3,370	100	8
VALRE35040	3,5 x 40 x 14	7,465	100	8
VALRE35050	3,5 x 50 x 14	7,588	100	8
VALRE40060	4 x 60 x 16	5,386	50	8
VALRE40070	4 x 70 x 16	6,772	50	8
VALRE40080	4 x 80 x 16	4,569	30	8

AL-PL

Alcayata plana



MULTIMATERIAL



CÓDIGO	MEDIDA	#	€/100		
ALPL45060	4,5 x 60 x 20	4	47,188	100	2.400
ALPL45080	4,5 x 80 x 20	5	59,739	100	1.200
ALPL45100	4,5 x 100 x 20	6	82,980	100	600
ALPL50120	5 x 120 x 25	7	122,809	100	400



Blister

CÓDIGO	MEDIDA	€/BOLSA	PCS. 	BOLSAS
BZALPL45060	4,5 x 60 x 20	3,427	4	20
BZALPL45080	4,5 x 80 x 20	3,427	4	20
BZALPL45100	4,5 x 100 x 20	3,427	2	15
BZALPL50120	5 x 120 x 25	3,427	2	10



Hembrillas

AL

MULTIMATERIAL



CÓDIGO	MEDIDA	€/100	ØD	L1	b	L2	d		
ALRO14025	14x25 (2,6 x 17 x 10)	3,317	2,6	17	10	10	2,6	500	22.500
ALRO16030	16x30 (3,1 x 20 x 10)	3,750	3,1	20	12	10	3,1	300	13.500
ALRO17040	17x40 (3,5 x 29 x 13)	5,273	3,5	29	17	13	3,5	300	7.200
ALRO18040	18x40 (3,7 x 28 x 14)	5,950	3,7	28	17	14	3,7	300	7.200
ALRO18050	18x50 (3,7 x 37 x 15)	6,463	3,7	37	22	15	3,7	300	7.200
ALRO19050	19x50 (4,4 x 37 x 15)	8,393	4,4	37	22	15	4,4	200	4.800
ALRO19060	19x60 (4,4 x 46 x 17)	9,023	4,4	46	28	17	4,4	200	4.800
ALRO19070	19x70 (4,4 x 55 x 18)	10,110	4,4	55	33	18	4,4	200	2.400
ALRO20060	20x60 (5 x 44 x 20)	11,053	5	44	26	20	5	200	2.400
ALRO20070	20x70 (5 x 53 x 20)	11,847	5	53	32	20	5	200	1.600
ALRO20080	20x80 (5 x 63 x 21)	13,270	5	63	38	21	5	200	2.400
ALRO21080	21x80 (5,6 x 60 x 22)	15,987	5,6	60	36	22	5,6	200	2.400
ALRO21090	21x90 (5,6 x 70 x 22)	17,710	5,6	70	42	22	5,6	200	800
ALRO22100	22x100 (6 x 79 x 23)	22,100	6	79	47	23	6	100	1.200
ALRO22110	22x110 (6 x 86 x 23)	24,030	6	86	52	23	6	100	1.200
ALRO22120	22x120 (6 x 97 x 25)	25,067	6	97	58	25	6	50	800
ALRO23130	23x130 (7,8 x 105 x 25)	33,933	7,8	105	63	25	7,8	50	600

AL-RO

Alcayata roscada

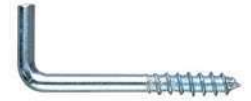

02 Info Técnica
P. 387

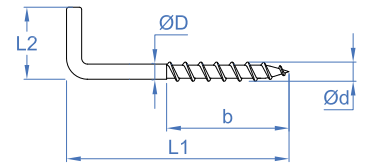

Blister

CÓDIGO	MEDIDA	€/BOLSA	PCS.	BOLSAS
BZALRO14025	14x25 (2,6 x 17 x 10)	2,029	25	20
BZALRO16030	16x30 (3,1 x 20 x 10)	2,029	15	20
BZALRO17040	17x40 (3,5 x 29 x 13)	2,029	15	20
BZALRO18040	18x40 (3,7 x 28 x 14)	2,029	15	20
BZALRO18050	18x50 (3,7 x 37 x 15)	2,029	15	20
BZALRO19050	19x50 (4,4 x 37 x 15)	2,029	10	20
BZALRO19060	19x60 (4,4 x 46 x 17)	2,029	10	20
BZALRO19070	19x70 (4,4 x 55 x 18)	2,029	10	20
BZALRO20060	20x60 (5 x 44 x 20)	2,029	8	20
BZALRO20070	20x70 (5 x 53 x 20)	2,029	8	20
BZALRO21080	21x80 (5,6 x 60 x 22)	2,029	6	20
BZALRO21090	21x90 (5,6 x 70 x 22)	2,029	6	20
BZALRO22100	22x100 (6 x 79 x 23)	2,029	4	20
BZALRO22110	22x110 (6 x 86 x 23)	2,029	2	20
BZALRO22120	22x120 (6 x 97 x 25)	2,029	2	20
BZALRO23130	23x130 (7,8 x 105 x 25)	2,029	2	20



Caja con Ventana

CÓDIGO	MEDIDA	€/CAJA	PCS.	CAJAS
VALRO14025	14x25 (2,6 x 17 x 10)	5,544	125	8
VALRO16030	16x30 (3,1 x 20 x 10)	3,782	75	8
VALRO17040	17x40 (3,5 x 29 x 13)	5,314	75	8
VALRO18040	18x40 (3,7 x 28 x 14)	5,967	75	8
VALRO18050	18x50 (3,7 x 37 x 15)	7,813	75	8
VALRO19050	19x50 (4,4 x 37 x 15)	6,767	60	8
VALRO19060	19x60 (4,4 x 46 x 17)	7,275	60	8
VALRO19070	19x70 (4,4 x 55 x 18)	8,151	60	8
VALRO20060	20x60 (5 x 44 x 20)	8,912	60	8
VALRO20070	20x70 (5 x 53 x 20)	9,550	60	8
VALRO20080	20x80 (5 x 63 x 21)	10,697	60	8
VALRO21080	21x80 (5,6 x 60 x 22)	15,040	50	8
VALRO21090	21x90 (5,6 x 70 x 22)	16,659	40	8
VALRO22100	22x100 (6 x 79 x 23)	10,606	35	8
VALRO22110	22x110 (6 x 86 x 23)	12,185	35	8
VALRO22120	22x120 (6 x 97 x 25)	7,834	20	8
VALRO23130	23x130 (7,8 x 105 x 25)	9,423	20	8

MULTIMATERIAL



CÓDIGO	MEDIDA	€/100	ØD	L1	b	L2	d		
ALROB16030	16x30 (3,1 x 20 x 10)	8,217	3,1	20	12	10	3,1	300	13.500
ALROB17040	17x40 (3,5 x 29 x 13)	10,383	3,5	29	17	13	3,5	300	7.200
ALROB18050	18x50 (3,7 x 37 x 15)	15,663	3,7	37	22	15	3,7	300	7.200
ALROB19060	19x60 (4,4 x 46 x 17)	17,997	4,4	46	28	17	4,4	200	4.800

AL-RO B

Alcayata roscada lacada blanca



02 Info Técnica
P. 387



Blister

CÓDIGO	MEDIDA	€/BOLSA	PCS.	BOLSAS
BZALROB1630	16x30 (3,1 x 20 x 10)	2,565	15	20
BZALROB1740	17x40 (3,5 x 29 x 13)	2,565	15	20
BZALROB1850	18x50 (3,7 x 37 x 15)	2,565	15	20
BZALROB1960	19x60 (4,4 x 46 x 17)	2,565	10	20



Caja con Ventana

CÓDIGO	MEDIDA	€/CAJA	PCS.	CAJAS
VALROB16030	16x30 (3,1 x 20 x 10)	7,868	75	8
VALROB17040	17x40 (3,5 x 29 x 13)	9,548	75	8
VALROB18050	18x50 (3,7 x 37 x 15)	13,787	75	8
VALROB19060	19x60 (4,4 x 46 x 17)	10,998	50	8

AL-HC

Hembrilla cerrada



02
P. 336
Info
Técnica

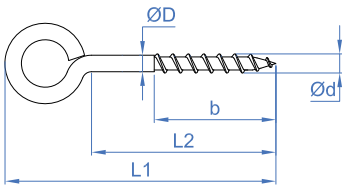

MULTIMATERIAL



CÓDIGO	MEDIDA	€/100	ØD	L1	b	L2	Ød		
ALHC14025	14x25 (2,6 x 18 x 7)	3,317	2,6	18	7	10	2,6	500	22.500
ALHC16030	16x30 (3,1 x 22 x 9)	3,750	3,1	22	9	12	3,1	300	13.500
ALHC17040	17x40 (3,5 x 28 x 10)	5,273	3,5	28	10	14	3,5	300	7.200
ALHC18040	18x40 (4,1 x 30 x 10)	5,950	4,1	30	10	15	4,1	300	7.200
ALHC18050	18x50 (3,7 x 39 x 12)	6,463	3,7	39	12	20	3,7	300	7.200
ALHC19050	19x50 (4,4 x 35 x 12)	8,393	4,4	35	12	18	4,4	200	4.800
ALHC19060	19x60 (4,4 x 42 x 15)	9,023	4,4	42	15	22	4,4	200	4.800
ALHC19070	19x70 (4,4 x 44 x 15)	10,110	4,4	44	15	24	4,4	200	4.800
ALHC20050	20x50 (5 x 39 x 12)	10,263	5	39	12	19	5	200	4.800
ALHC20060	20x60 (5 x 41 x 12)	11,053	5	41	12	21	5	200	3.200
ALHC20070	20x70 (5 x 48 x 14)	11,847	5	48	14	26	5	200	2.400
ALHC20080	20x80 (5 x 54 x 18)	13,270	5	54	18	30	5	200	2.400
ALHC21070	21x70 (5,6 x 49 x 14)	14,630	5,6	49	14	23	5,6	200	2.400
ALHC21080	21x80 (5,6 x 54 x 14)	15,987	5,6	54	14	28	5,6	200	2.400
ALHC21090	21x90 (5,6 x 61 x 14)	17,710	5,6	61	14	32	5,6	200	1.200
ALHC21100	21x100 (5,6 x 66 x 18)	17,733	5,6	66	18	37	5,6	100	1.200
ALHC22110	22x110 (6 x 73 x 24)	24,030	6	73	24	43	6	100	1.200
ALHC22120	22x120 (6 x 81 x 29)	25,067	6	81	29	48	6	50	600
ALHC23130	23x130 (6,3 x 89 x 35)	33,933	6,3	89	35	55	6,3	50	600

Blister

CÓDIGO	MEDIDA	€/BOLSA	PCS. 	BOLSAS
BZALHC14025	14x25 (2,6 x 18 x 7)	2,029	25	20
BZALHC16030	16x30 (3,1 x 22 x 9)	2,029	15	20
BZALHC17040	17x40 (3,5 x 28 x 10)	2,029	15	20
BZALHC18040	18x40 (4,1 x 30 x 10)	2,029	15	20
BZALHC18050	18x50 (3,7 x 39 x 12)	2,029	15	20
BZALHC19050	19x50 (4,4 x 35 x 12)	2,029	10	20
BZALHC19060	19x60 (4,4 x 42 x 15)	2,029	10	20
BZALHC19070	19x70 (4,4 x 44 x 15)	2,029	10	20
BZALHC20060	20x60 (5 x 41 x 12)	2,029	8	20
BZALHC20070	20x70 (5 x 48 x 14)	2,029	8	20
BZALHC20080	20x80 (5 x 54 x 18)	2,029	8	15
BZALHC21080	21x80 (5,6 x 54 x 14)	2,029	6	15
BZALHC21090	21x90 (5,6 x 61 x 14)	2,029	6	15
BZALHC21100	21x100 (5,6 x 66 x 18)	2,029	4	20
BZALHC22110	22x110 (6 x 76 x 24)	2,029	2	20
BZALHC22120	22x120 (6 x 81 x 29)	2,029	2	20
BZALHC23130	23x130 (6,3 x 89 x 35)	2,029	2	20

Caja con Ventana

CÓDIGO	MEDIDA	€/CAJA	PCS. 	CAJAS
VALHC14025	14x25 (2,6 x 18 x 7)	5,544	125	8
VALHC16030	16x30 (3,1 x 22 x 9)	3,782	75	8
VALHC17040	17x40 (3,5 x 28 x 10)	5,314	75	8
VALHC18040	18x40 (4,1 x 30 x 10)	5,967	75	8
VALHC18050	18x50 (3,7 x 39 x 12)	7,813	75	8
VALHC19050	19x50 (4,4 x 35 x 12)	6,767	60	8
VALHC19060	19x60 (4,4 x 42 x 15)	7,275	60	8
VALHC19070	19x70 (4,4 x 44 x 15)	8,151	60	8
VALHC20050	20x50 (5 x 39 x 12)	8,274	60	8
VALHC20060	20x60 (5 x 41 x 12)	8,912	60	8
VALHC20070	20x70 (5 x 48 x 14)	9,550	60	8
VALHC20080	20x80 (5 x 54 x 18)	10,697	60	8
VALHC21070	21x70 (5,6 x 49 x 14)	13,689	60	8
VALHC21080	21x80 (5,6 x 54 x 14)	15,040	50	8
VALHC21090	21x90 (5,6 x 61 x 14)	16,659	40	8
VALHC21100	21x100 (5,6 x 66 x 18)	9,027	35	8
VALHC22110	22x110 (6 x 73 x 24)	12,185	20	8
VALHC22120	22x120 (6 x 81 x 29)	7,834	20	8
VALHC23130	23x130 (6,3 x 89 x 35)	9,423	20	8

AL-HC B

Hembrilla cerrada roscada lacada blanca



02
P. 337
Info
Técnica

MULTIMATERIAL



CÓDIGO	MEDIDA	€/100	ØD	L1	b	L2	Ød		
ALHCB16030	16x30 (3,1 x 22 x 9)	8,217	3,1	22	9	12	3,1	300	13.500
ALHCB17040	17x40 (3,5 x 28 x 10)	10,383	3,5	28	10	14	3,5	300	7.200
ALHCB18050	18x50 (3,7 x 39 x 12)	15,663	3,7	39	12	20	3,7	300	7.200
ALHCB19060	19x60 (4,4 x 42 x 15)	17,997	4,4	42	15	22	4,4	200	4.800

Blister

CÓDIGO	MEDIDA	€/BOLSA	PCS. 	BOLSAS
BZALHCB1630	16x30 (3,1 x 22 x 9)	2,565	15	20
BZALHCB1740	17x40 (3,5 x 28 x 10)	2,565	15	20
BZALHCB1850	18x50 (3,7 x 39 x 12)	2,565	15	20
BZALHCB1960	19x60 (4,4 x 42 x 15)	2,565	10	20



Hembrillas

HB

MULTIMATERIAL



CÓDIGO	MEDIDA	€/100	ØD	L1	B	L2	Ød		
ALHA14025	14x25 (2,6 x 18 x 7)	3,317	2,6	18	7	10	2,6	500	22.500
ALHA16030	16x30 (3,1 x 22 x 9)	3,750	3,1	22	9	12	3,1	300	13.500
ALHA17040	17x40 (3,5 x 26 x 10)	5,273	3,5	26	10	14	3,5	300	7.200
ALHA18040	18x40 (4,1 x 29 x 10)	5,950	4,1	29	10	15	4,1	300	7.200
ALHA18050	18x50 (4,1 x 34 x 12)	6,463	4,1	34	12	20	4,1	300	3.600
ALHA19050	19x50 (4,4 x 33 x 12)	8,393	4,4	33	12	18	4,4	200	4.800
ALHA19060	19x60 (4,4 x 39 x 15)	9,023	4,4	39	15	22	4,4	200	4.800
ALHA19070	19x70 (4,4 x 41 x 15)	10,110	4,4	41	15	24	4,4	200	2.400
ALHA20050	20x50 (5 x 35 x 12)	10,263	5	35	12	19	5	200	2.400
ALHA20060	20x60 (5 x 39 x 12)	11,053	5	39	12	21	5	200	2.400
ALHA20070	20x70 (5 x 44 x 14)	11,847	5	44	14	26	5	200	2.400
ALHA20080	20x80 (5 x 50 x 18)	13,270	5	50	18	30	5	200	2.400
ALHA21070	21x70 (5,6 x 43 x 14)	14,630	5,6	43	14	23	5,6	200	2.400
ALHA21080	21x80 (5,6 x 48 x 14)	15,987	5,6	48	14	28	5,6	200	2.400
ALHA21090	21x90 (5,6 x 56 x 14)	17,710	5,6	56	14	32	5,6	200	1.200
ALHA21100	21x100 (5,6 x 61 x 18)	17,733	5,6	61	18	37	5,6	100	1.200
ALHA22110	22x110 (6 x 69 x 24)	24,030	6	69	24	43	6	100	1.200
ALHA22120	22x120 (6 x 74 x 29)	25,067	6	74	29	48	6	50	600
ALHA23130	23x130 (6,3 x 82 x 35)	33,933	6,3	82	35	55	6,3	50	600



Blister

CÓDIGO	MEDIDA	€/BOLSA	PCS. B	BOLSAS
BZALHA14025	14x25 (2,6 x 18 x 7)	2,029	25	20
BZALHA16030	16x30 (3,1 x 22 x 9)	2,029	15	20
BZALHA17040	17x40 (3,5 x 26 x 10)	2,029	15	20
BZALHA18040	18x40 (4,1 x 29 x 10)	2,029	15	20
BZALHA18050	18x50 (3,7 x 34 x 12)	2,029	15	20
BZALHA19050	19x50 (4,4 x 33 x 12)	2,029	10	20
BZALHA19060	19x60 (4,4 x 39 x 15)	2,029	10	20
BZALHA19070	19x70 (4,4 x 41 x 15)	2,029	10	20
BZALHA20060	20x60 (5 x 39 x 12)	2,029	8	20
BZALHA20070	20x70 (5 x 44 x 14)	2,029	8	20
BZALHA20080	20x80 (5 x 50 x 18)	2,029	8	20
BZALHA21080	21x80 (5,6 x 48 x 14)	2,029	6	20
BZALHA21090	21x90 (5,6 x 56 x 14)	2,029	6	20
BZALHA21100	21x100 (5,6 x 61 x 18)	2,029	5	15
BZALHA22110	22x110 (6 x 69 x 24)	2,029	2	15
BZALHA22120	22x120 (6 x 74 x 29)	2,029	2	15
BZALHA23130	23x130 (6,3 x 89 x 35)	2,029	2	15



Caja con Ventana

CÓDIGO	MEDIDA	€/CAJA	PCS. B	CAJAS
VALHA14025	14x25 (2,6 x 18 x 7)	5,544	125	8
VALHA16030	16x30 (3,1 x 22 x 9)	3,782	75	8
VALHA17040	17x40 (3,5 x 26 x 10)	5,314	75	8
VALHA18040	18x40 (4,1 x 29 x 10)	5,967	75	8
VALHA18050	18x50 (3,7 x 34 x 12)	7,813	75	8
VALHA19050	19x50 (4,4 x 33 x 12)	6,767	60	8
VALHA19060	19x60 (4,4 x 39 x 15)	7,275	60	8
VALHA19070	19x70 (4,4 x 41 x 15)	8,151	60	8
VALHA20050	20x50 (5 x 35 x 12)	8,274	60	8
VALHA20060	20x60 (5 x 39 x 12)	8,912	60	8
VALHA20070	20x70 (5 x 44 x 14)	9,550	60	8
VALHA20080	20x80 (5 x 50 x 18)	10,697	60	8
VALHA21070	21x70 (5,6 x 43 x 14)	13,689	60	8
VALHA21080	21x80 (5,6 x 48 x 14)	15,040	50	8
VALHA21090	21x90 (5,6 x 56 x 14)	16,659	40	8
VALHA21100	21x100 (5,6 x 61 x 18)	9,027	35	8
VALHA22110	22x110 (6 x 69 x 24)	12,185	20	8
VALHA22120	22x120 (6 x 74 x 29)	7,834	20	8
VALHA23130	23x130 (6,3 x 82 x 35)	9,423	20	8



Blister

CÓDIGO	MEDIDA	€/BOLSA	PCS. B	BOLSAS
BZALHAB1630	16x30 (3,1 x 22 x 9)	2,565	15	20
BZALHAB1740	17x40 (3,5 x 26 x 10)	2,565	15	20
BZALHAB1850	18x50 (4,1 x 34 x 12)	2,565	15	20
BZALHAB1960	19x60 (4,4 x 39 x 15)	2,565	10	20



Caja con Ventana

CÓDIGO	MEDIDA	€/CAJA	PCS. B	CAJAS
VALHAB16030	16x30 (3,1 x 22 x 9)	7,868	75	8
VALHAB17040	17x40 (3,5 x 26 x 10)	9,548	75	8
VALHAB18050	18x50 (4,1 x 34 x 12)	13,787	75	8
VALHAB19060	19x60 (4,4 x 39 x 15)	10,998	50	8

AL-HA

Hembrilla abierta



02
P. 386

Info.
Técnica

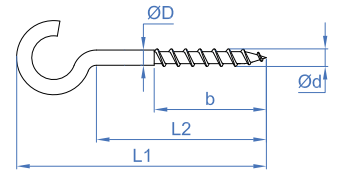

AL-HA B

Hembrilla abierta roscada lacada
blanca



02
P. 386

Info.
Técnica

HB

Hembrillas

HC-RM

Hembrilla cerrada. Rosca métrica con tuerca



MULTIMATERIAL



CÓDIGO	MEDIDA	€/100		
HCRM03026	3 x 26	31,540	100	4.500
HCRM04035	4 x 35	35,043	100	2.400
HCRM05037	5 x 37	41,853	100	1.200
HCRM06050	6 x 50	84,683	100	1.200
HCRM08060	8 x 60	97,337	100	600
HCRM10065	10 x 65	175,203	50	300
HCRM12075	12 x 75	233,603	50	150



Blister

CÓDIGO	MEDIDA	€/BOLSA	PCS. 	BOLSAS
BZHCRM03026	3 x 26	2,029	15	20
BZHCRM04035	4 x 35	2,029	15	20
BZHCRM05037	5 x 37	2,029	8	20
BZHCRM06050	6 x 50	2,029	6	20
BZHCRM08060	8 x 60	2,029	2	20
BZHCRM10065	10 x 65	2,029	2	20

HA-RM

Hembrilla abierta. Rosca métrica con tuerca



MULTIMATERIAL



CÓDIGO	MEDIDA	€/100		
HARM03026	3 x 26	31,540	100	4.500
HARM04035	4 x 35	35,043	100	2.400
HARM05037	5 x 37	41,853	100	1.200
HARM06050	6 x 50	84,683	100	1.200
HARM08060	8 x 60	97,337	50	300



Blister

CÓDIGO	MEDIDA	€/BOLSA	PCS. 	BOLSAS
BZHARM03026	3 x 26	2,029	15	20
BZHARM04035	4 x 35	2,029	15	20
BZHARM05037	5 x 37	2,029	8	20
BZHARM06050	6 x 50	2,029	6	20
BZHARM08060	8 x 60	2,029	2	20



Puntas clavado

PC

MULTIMATERIAL



CÓDIGO	MEDIDA	€/100		
PACP22520	2,25 x 20	1,257	500	22.500
PACP22525	2,25 x 25	1,493	500	22.500
PACP22530	2,25 x 30	1,723	500	12.000
PACP25040	2,50 x 40	2,813	500	12.000
PACP25050	2,50 x 50	2,920	500	6.000
PACP29050	2,90 x 50	4,193	300	3.600
PACP29060	2,90 x 60	4,907	300	3.600
PACP29070	2,90 x 70	5,633	300	2.400
PACP34030	3,40 x 30	3,350	500	4.000
PACP34040	3,40 x 40	4,063	500	6.000
PACP34050	3,40 x 50	6,000	100	4.500
PACP34060	3,40 x 60	6,450	100	2.400
PACP34070	3,40 x 70	7,343	100	2.400
PACP34080	3,40 x 80	8,557	100	1.600

PA-CP

Puntas acero cabeza plana



Blister

CÓDIGO	MEDIDA	€/BOLSA	PCS. 	BOLSAS
BZPACP22520	2,25 x 20	2,565	50	20
BZPACP22525	2,25 x 25	2,565	50	20
BZPACP22530	2,25 x 30	2,565	50	20
BZPACP25040	2,50 x 40	2,565	35	20
BZPACP25050	2,50 x 50	2,565	30	20
BZPACP29060	2,90 x 60	2,565	20	20
BZPACP29070	2,90 x 70	2,565	20	20
BZPACP34040	3,40 x 40	2,565	20	20
BZPACP34050	3,40 x 50	2,565	10	20
BZPACP34060	3,40 x 60	2,565	10	20
BZPACP34070	3,40 x 70	2,565	10	20

MADERA



CÓDIGO	MEDIDA	€/100		
PACC15015	1,5 x 15	0,477	800	36.000
PACC15020	1,5 x 20	0,597	800	36.000
PACC15025	1,5 x 25	0,837	500	22.500
PACC20025	2 x 25	1,143	500	22.500
PACC20030	2 x 30	1,293	500	12.000
PACC20035	2 x 35	1,483	500	12.000
PACC20040	2 x 40	1,667	500	12.000
PACC20045	2 x 45	1,947	500	6.000
PACC20050	2 x 50	2,127	500	6.000

PA-CC

Puntas acero cabeza cónica cobreada



Blister

CÓDIGO	MEDIDA	€/BOLSA	PCS. 	BOLSAS
BZPACC15015	1,5 x 15	2,029	75	20
BZPACC15020	1,5 x 20	2,029	50	20
BZPACC15025	1,5 x 25	2,029	50	20
BZPACC20025	2 x 25	2,029	50	20
BZPACC20030	2 x 30	2,029	50	20
BZPACC20035	2 x 35	2,029	50	20
BZPACC20040	2 x 40	2,029	35	20
BZPACC20045	2 x 45	2,029	35	20
BZPACC20050	2 x 50	2,029	30	20



Caja con Ventana

CÓDIGO	MEDIDA	€/CAJA	PCS. 	CAJAS
VPACC15015	1,5 x 15	2,008	240	8
VPACC15020	1,5 x 20	2,292	240	8
VPACC15025	1,5 x 25	2,031	150	8
VPACC20025	2 x 25	2,664	150	8
VPACC20030	2 x 30	2,917	150	8
VPACC20035	2 x 35	3,334	150	8
VPACC20040	2 x 40	3,751	150	8
VPACC20045	2 x 45	4,167	150	8
VPACC20050	2 x 50	4,375	150	8

PC

Puntas clavado

PA-CX

Puntas latón cabeza convexa



Blister

CÓDIGO	MEDIDA	€/BOLSA	PCS. 	BOLSAS
BZPACX11010	1,1 x 10	2,565	75	20
BZPACX13012	1,3 x 12	2,565	50	20
BZPACX13020	1,3 x 20	2,565	40	20
BZPACX15016	1,5 x 16	2,565	35	20
BZPACX15025	1,5 x 25	2,565	20	20
BZPACX18030	1,8 x 30	2,565	20	20

MADERA



GM-Z

Grampillón



Blister

CÓDIGO	MEDIDA	€/BOLSA	PCS. 	BOLSAS
BZGMZ08012	8 x 12	2,029	50	20
BZGMZ10016	10 x 16	2,029	40	20
BZGMZ12020	12 x 20	2,029	50	20
BZGMZ15026	15 x 26	2,029	40	20
BZGMZ17030	17 x 30	2,029	25	20
BZGMZ19035	19 x 35	2,029	15	20

MADERA



Caja con Ventana

CÓDIGO	MEDIDA	€/CAJA	PCS. 	CAJAS
VGMZ10016	10 x 16	3,025	240	8
VGMZ15026	15 x 26	8,126	200	8
VGMZ19035	19 x 35	9,584	100	8

CF-B

Colgador cuadro fácil



Blister

CÓDIGO	COLOR	€/BOLSA	PCS. 	BOLSAS
BZCFBL	<input type="text"/>	2,565	10	20

MULTIMATERIAL



Caja con Ventana

CÓDIGO	COLOR	€/CAJA	PCS. 	CAJAS
VCFBL	<input type="text"/>	25,186	150	8

* Gamas Blíster y Caja Ventana con aplicador incluido



Puntas clavado

PC



CÓDIGO	MEDIDA	€/100		
SVNB01	Pequeño	12,473	300	3.600
SVNB02	Grande	17,007	200	2.400



Blister

CÓDIGO	MEDIDA	€/BOLSA	PCS.	BOLSAS
BZSVNB01	Pequeño	3,427	10	20
BZSVNB02	Grande	3,427	8	20



Caja con Ventana

CÓDIGO	MEDIDA	€/CAJA	PCS.	CAJAS
VSVNB01	Pequeño	13,567	90	8
VSVNB02	Grande	10,664	50	8

SV-NB

Soporte vitrina blanco



CÓDIGO	MEDIDA	€/100		
SVNM01	Pequeño	12,473	300	3.600
SVNM02	Grande	17,007	200	2.400



Blister

CÓDIGO	MEDIDA	€/BOLSA	PCS.	BOLSAS
BZSVNM01	Pequeño	3,427	10	20
BZSVNM02	Grande	3,427	8	20



Caja con Ventana

CÓDIGO	MEDIDA	€/CAJA	PCS.	CAJAS
VSVNM01	Pequeño	13,567	90	8
VSVNM02	Grande	10,664	50	8

SV-NM

Soporte vitrina marrón



CÓDIGO	COLOR	€/100		
SVCBL		17,007	300	3.600
SVCMA		17,007	300	3.600



Blister

CÓDIGO	COLOR	€/BOLSA	PCS.	BOLSAS
BZSVCBL		3,427	10	20
BZSVCMA		3,427	10	20



Caja con Ventana

CÓDIGO	COLOR	€/CAJA	PCS.	CAJAS
VSVCBL		17,962	90	8
VSVCMA		17,962	90	8

SV-C

Soporte vitrina cuadrado 2 puntas



MALETINES MULTIREFERENCIA

MALETÍN PROFESIONAL: TIRAFONDOS MADERA + PUNTAS



2.008 pcs.
COD. MLTPPOP101

TP-PO 3 x 20 x300	TP-PO 3 x 25 x250	TP-PO 3,5 x 16 x300	TP-PO 3,5 x 20 x250
TP-PO 3,5 x 25 x200	TP-PO 3,5 x 30 x150	TP-PO 3,5 x 35 x130	TP-PO 4 x 30 x130
TP-PO 4 x 40 x80	TP-PO 4 x 50 x60	TP-PO 5 x 50 x50	TP-PO 5 x 60 x50
TP-PO 5 x 80 x50			PUNTAS x8

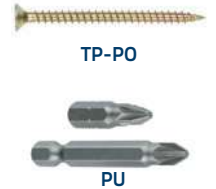

TP-PO

PU

CARACTERÍSTICAS:

- Maletín multiproducto de alta calidad
- Tamaño: 31,2 x 23,8 x 5,1 cms. (Ancho x Fondo x Alto)
- Ergonómico y de fácil manejo
- Apilable
- Configurable hasta 21 cavidades
- Separadores regulables
- Tapa con nervios que evita que se mezclen los tornillos
- Cierre resistente y duradero

CÓDIGO	CONTENIDO	Nº PIEZAS	€/1 pc.
MLTPPOP101	TP-PO+PUNTAS	2.008	65,359

MALETÍN PROFESIONAL MULTIPRODUCTO



670 pcs.
COD. MLTBOP101

TP-PO 5 x 60 x30	TP-PO 5 x 70 x20	TP-PO 5 x 80 x20	DIN-571 6 x 60 x25
TP-PO 4 x 50 x50	TP-PO 5 x 50 x50	TACON Ø 10 x15	DIN-571 6 x 50 x30
TP-PO 3,5 x 25 x60	TP-PO 4 x 30 x70	TP-PO 4 x 40 x70	DIN-571 6 x 40 x30
			TACON Ø 6 x150

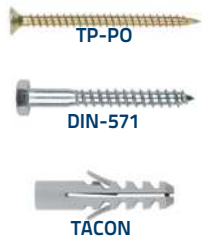

TP-PO

DIN-571

TACON

CARACTERÍSTICAS:

- Maletín multiproducto de alta calidad
- Tamaño: 31,2 x 23,8 x 5,1 cms. (Ancho x Fondo x Alto)
- Ergonómico y de fácil manejo
- Apilable
- Configurable hasta 21 cavidades
- Separadores regulables
- Tapa con nervios que evita que se mezclen los tornillos
- Cierre resistente y duradero

CÓDIGO	CONTENIDO	Nº PIEZAS	€/1 pc.
MLTBOP101	TP-PO+DIN-571 +TACON	670	64,191

MALETINES MULTIREFERENCIA

MALETÍN TRANSPARENTE

CARACTERÍSTICAS:

- Tres composiciones adaptadas a las necesidades de cada cliente.
- Tres tamaños disponibles para cada composición.
- Permite colgarse en lineal. Dispone de un colgador de alta resistencia.
- Composiciones ideales para aumentar la compra impulsiva en el punto de venta.
- Tapa con nervios que evita que se mezclen los tornillos.

TAMAÑOS



GRANDE
29,5 x 18,5 x 4,5 cms.
(Ancho x Fondo x Alto)



MEDIANO
23,5 x 14,5 x 4 cms.
(Ancho x Fondo x Alto)



PEQUEÑO
16 x 10,5 x 3,5 cms.
(Ancho x Fondo x Alto)

COMPOSICIONES:

MADERA



TP-PO



PU-PO

CÓDIGO	CONTENIDO	TAMAÑO	Nº PIEZAS	€/1 pc.
MLTPPOT101	TP-PO + PUNTAS	PEQUEÑO	407	16,914
MLTPPOT201	TP-PO + PUNTAS	MEDIANO	902	31,406
MLTPPOT301	TP-PO + PUNTAS	GRANDE	1.742	50,677

MULTIPRODUCTO



TACON



AL-RO



AL-HA



AL-HC



TP-PO Z



DIN-571

CÓDIGO	CONTENIDO	TAMAÑO	Nº PIEZAS	€/1 pc.
MLMULT101	MULTIPRODUCTO	PEQUEÑO	165	16,914
MLMULT201	MULTIPRODUCTO	MEDIANO	415	31,406
MLMULT301	MULTIPRODUCTO	GRANDE	1.155	49,772

PLACA DE YESO LAMINADO



AL-HC



AL-RO



AL-HA



TP-PO Z



ANCLA



IN-CO



T4S



TAPLANY



TAPLAME
+ DIN-7981

CÓDIGO	CONTENIDO	TAMAÑO	Nº PIEZAS	€/1 pc.
MLPLAT101	MULTIPRODUCTO	PEQUEÑO	130	16,914
MLPLAT201	MULTIPRODUCTO	MEDIANO	295	31,406
MLPLAT301	MULTIPRODUCTO	GRANDE	455	49,772



CONECTORES PARA MADERA



SO

Soportes perforados

SO-UO

Con orificios de sellado

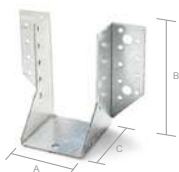

CÓDIGO	A x B x C	€/100	Nº AGUJEROS	Ø ORIFICIOS	ESPESOR	
SOU004110	40 x 110 x 80	545,313	4/1/22	11/7/4,6	2	25
SOU006100	60 x 100 x 80	548,870	4/1/22	11/7/4,6	2	25
SOU007125	70 x 125 x 80	606,157	4/1/28	11/7/4,6	2	25
SOU008120	80 x 120 x 80	621,310	4/1/28	11/7/4,6	2	25
SOU010140	100 x 140 x 80	738,810	4/1/34	11/7/4,6	2	10

SO-UR

De ancho variable con orificios de sellado

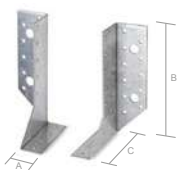

CÓDIGO	A x B x C	€/100	Nº AGUJEROS	Ø ORIFICIOS	ESPESOR	
SOUR30140DR	26 x 140 x 76	543,270	2/20	11/4,5	2	25
SOUR30140IZ	26 x 140 x 76	543,270	2/20	11/4,5	2	25

SC

Escuadras para unión de madera

SC-EI

De ensamble, perforada con orificios iguales

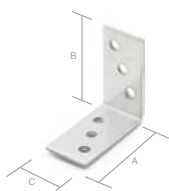

CÓDIGO	A x B x C	€/100	Nº AGUJEROS	Ø ORIFICIOS	ESPESOR	
SCEI040402	40 x 40 x 20	73,637	6	4,5	2	100
SCEI040404	40 x 40 x 40	115,720	8	4,6	2	50
SCEI040406	40 x 40 x 60	189,450	12	4,6	2,5	50
SCEI050504	50 x 50 x 40	133,603	8	4,5	2	50
SCEI060604	60 x 60 x 40	179,327	12	5	2,5	50
SCEI060606	60 x 60 x 60	227,523	18	5	2,5	50
SCEI060608	60 x 60 x 80	401,597	20	4,6	2,5	25
SCEI070704	75 x 75 x 40	248,427	12	4,6	2	50
SCEI080808	80 x 80 x 80	463,733	28	4,6	2,5	25
SCEI101004	100 x 100 x 40	294,900	14	4,6	2	50
SCEI101010	100 x 100 x 100	729,730	46	4,6	2,5	25

SC-ED

De ensamble, perforada con orificios desiguales

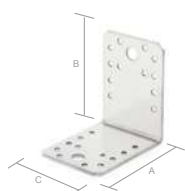

CÓDIGO	A x B x C	€/100	Nº AGUJEROS	Ø ORIFICIOS	ESPESOR	
SCED050503	50 x 50 x 35	131,663	2/12	11/4,5	2,5	50
SCED060604	60 x 60 x 45	206,307	2/12	10,4/4,8	2,5	50
SCED070705	70 x 70 x 55	277,633	2/20	10,4/4,6	2,5	50
SCED090904	90 x 90 x 40	295,500	4/16	10,4/4,6	3	50
SCED090906	90 x 90 x 65	297,467	5/15	12,8/4,6	2,5	25
SCED101009	105 x 105 x 90	601,630	5/29	12,8/4,6	3	25

TIRAFONDO DE ALTAS PRESTACIONES PARA MADERA

TEX



Asentamiento perfecto en cualquier superficie.



Disminuye el agrietamiento de la madera

Escuadras para unión de madera

SC



CÓDIGO	A x B x C	€/100	Nº AGUJEROS	Ø ORIFICIOS	ESPESOR	
SCLD040606	60 x 60 x 40	292,383	2/13	11/5	2,5	50
SCLD060806	60 x 80 x 60	371,423	3/18	11/5	2,5	50

SC-LD

De ensamblaje de lados iguales

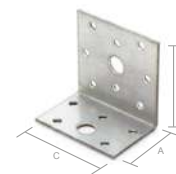

CÓDIGO	A x B x C	€/100	Nº AGUJEROS	Ø ORIFICIOS	ESPESOR	
SCGA100404	40 x 40 x 100	304,373	16	5	2	25

SC-GA

Grande de ángulo



CÓDIGO	A x B x C	€/100	Nº AGUJEROS	Ø ORIFICIOS	ESPESOR	
SCRFO70705	70 x 70 x 55	281,460	2/12	2/12	2	50
SCRFO70605	77 x 64 x 50	249,333	2/10	11/4,6	2,5	50
SCRFO90906	90 x 90 x 65	355,775	2/24	11/4,5	2,5	25
SCRFO101009	100 x 100 x 90	616,274	4/26	13,4/4,6	3	25
SCRFO151506	150 x 150 x 65	581,590	3/13/1/15	11/5/11x32/5	2,5	25

SC-RF

Reforzada



CÓDIGO	A x B x C	€/100	Nº AGUJEROS	Ø ORIFICIOS	ESPESOR	
SCRG090505	50 x 90 x 50	300,830	3/15	11/4,6	2,5	50
SCRG090508	50 x 90 x 80	421,730	5/16	13/4,6	2,5	50

SC-RG

Regulable



CÓDIGO	A x B x C	€/100	Nº AGUJEROS	Ø ORIFICIOS	ESPESOR	
SCAS3317DR	32 x 100 x 170	217,707	20	5	2	50
SCAS3317IZ	32 x 100 x 170	217,707	20	5	2	50

SC-AS

Asimétrica, derecha o izquierda

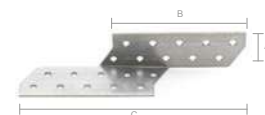

CÓDIGO	Z T	€/100	Nº AGUJEROS	Ø ORIFICIOS	ESPESOR	
SCCE200404	40 x 200 x 40	342,327	18+1	4,5/11	2	10

SC-CE

Para cemento

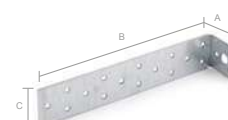

SC

Escuadras para unión de madera

SC-OB

Bicromatada para sillas con orificios biselados en ambas caras

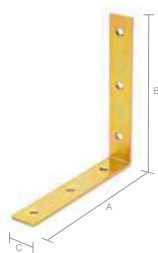

CÓDIGO	A x B x C	€/100	Nº AGUJEROS	Ø ORIFICIOS	ESPESOR	
SCOB020214	25 x 25 x 15	54,180	4	4	1,8	100
SCOB030314	30 x 30 x 15	62,253	4	4,6	2	100
SCOB040415	40 x 40 x 15	72,677	4	4,5	1,8	100
SCOB050515	50 x 50 x 15	81,713	4	5	2	100
SCOB060618	60 x 60 x 16	89,973	4	5	2	100
SCOB070718	75 x 75 x 18	117,920	4	5,2	2	50
SCOB090920	90 x 90 x 20	154,227	4	6,5	2	50
SCOB101020	100 x 100 x 20	175,630	6	5,5	2	40
SCOB121222	125 x 125 x 22	281,703	6	5,5	2,5	40

NEW SC-OZ

Cincada para sillas con orificios biselados en ambas caras



CÓDIGO	MEDIDA	€/100	Nº AGUJEROS	
SCOZ151525	150 x 150 x 25	411,373	6	10

SC-CD Z

Cincada grande y de caras desiguales



CÓDIGO	A x B x C	€/100	Nº AGUJEROS	Ø ORIFICIOS	ESPESOR	
SCCDZ402575	25 x 40 x 75	269,890	5	4,6	2	20

SC-CI

Bicromatada grande y de caras iguales

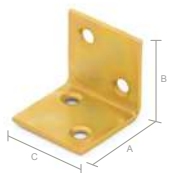

CÓDIGO	A x B x C	€/100	Nº AGUJEROS	Ø ORIFICIOS	ESPESOR	
SCCI303030	30 x 30 x 30	98,353	4	4,6	2	100
SCCI404040	40 x 40 x 40	124,487	4	4,6	2	50
SCCI606060	60 x 60 x 60	248,817	8	4,5	2	50

SC-EM

Bicromatada para empotrar



CÓDIGO	A x B x C	€/100	Nº AGUJEROS	Ø ORIFICIOS	ESPESOR	
SCEM081240	80 x 120 x 40	551,130	5	4,7	1,6	20
SCEM101640	100 x 160 x 37	615,857	5	4,5	2	20

Escuadras para unión de madera

SC



CÓDIGO	A x B x C	€/100	Nº AGUJEROS	Ø ORIFICIOS	ESPESOR	
SCER302525	25 x 25 x 30	123,163	1/2	4,5 x 14/4,5	1,2	50
SCER392822	39 x 28 x 22	105,557	1/1	4,5 x 16/4,5	1	50

SC-ER

Bicromatada regulable para empotrar

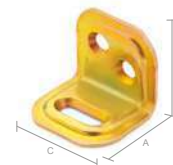

CÓDIGO	A x B x C	€/100	Nº AGUJEROS	Ø ORIFICIOS	ESPESOR	
SCGEZ704025	25 x 40 x 70	254,933	5	4,5	1,5	20

SC-GE Z

Cincada grande y regulable para empotrar



CÓDIGO	A x B x C	€/100	Nº AGUJEROS	Ø ORIFICIOS	ESPESOR	
SCLCZ354030	34 x 38 x 30	153,643	2	4	2	100

SC-LC

Galvanizada y bicromatada, en L, para cercados de celosía con tornillo soldado

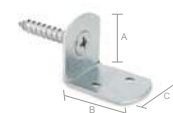

CÓDIGO	A x B x C	€/KIT	Nº AGUJEROS	Ø ORIFICIOS	ESPESOR	KITS X 
SCMX020214	25 x 25 x 14	4,656	4	4	1,8	10
SCMX030314	30 x 30 x 14	5,140	4	4	1,8	10
SCMX040415	40 x 40 x 15	5,914	4	4,2	1,8	10
SCMX050515	50 x 50 x 15	7,422	4	4,6	1,8	10
SCMX060618	60 x 60 x 18	8,414	4	4,5	1,8	10
SCMX070718	75 x 75 x 18	8,883	4	5	2	10

SC-MX

Bicromatada para sillas en maxipack (10 uds)

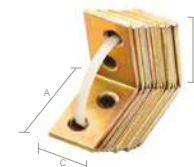

CÓDIGO	A x B x C	€/100	Nº AGUJEROS	Ø ORIFICIOS	ESPESOR	
SCPD107530	75 x 100 x 30	287,403	5	5	2,5	50
SCPD128035	80 x 120 x 35	493,387	7	4,5	3,5	25

SC-PD

Bicromatada para poste, de caras desiguales



CÓDIGO	A x B x C	€/100	Nº AGUJEROS	Ø ORIFICIOS	ESPESOR	
SCREZ357565	35 x 75 x 65	614,327	3/2/2	7/7 x 25/7 x 60	3	10

SC-RE Z

Cincada regulable



PT

Pletinas para unión de madera

PT-BR

De ensamble y brida plana



CÓDIGO	MEDIDA	€/100	Nº AGUJEROS	Ø ORIFICIOS	GROSOR	
PTBR10035	95 x 35	138,280	2/12	11/4,5	2,5	50
PTBR13355	135 x 55	300,450	2/20	11/4,5	2,5	50

PT-EM

Bicromatada para empotrar

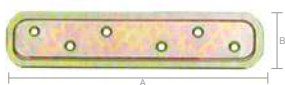

CÓDIGO	MEDIDA	€/100	Nº AGUJEROS	Ø ORIFICIOS	GROSOR	
PTEM18040	180 x 40	367,787	6	4,7	2	20

PT-ET

En "T"



CÓDIGO	MEDIDA	€/100	Nº AGUJEROS	Ø ORIFICIOS	GROSOR	
PTET169845	160 x 98 x 45	1.385,207	4/20	11/4,5	2,5	25

PT-OB

Bicromatada de unión, con orificios biselados en ambas caras



CÓDIGO	MEDIDA	€/100	Nº AGUJEROS	Ø ORIFICIOS	GROSOR	
PTOB05015	50 x 15	61,560	4	4,7	1,75	100
PTOB06015	60 x 15	70,360	4	4,5	1,75	100
PTOB08015	80 x 15	79,157	4	4,5	1,75	100
PTOB10015	100 x 15	87,960	4	5	1,75	100
PTOB12020	120 x 20	96,700	4	5,5	1,75	100

PT-TT

En "T"

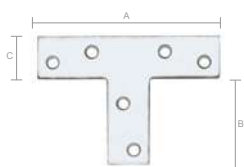

CÓDIGO	MEDIDA	€/100	Nº AGUJEROS	Ø ORIFICIOS	GROSOR	
PTTT030716	70 x 35 x 16	170,920	6	4,3	1,5	50
PTTT111430	140 x 80 x 30	377,120	6	5	2	25

PT-UN

De ensamble universal



CÓDIGO	MEDIDA	€/100	Nº AGUJEROS	Ø ORIFICIOS	GROSOR	
PTUN12038	120 x 40	149,500	10	11/4,5	2	50
PTUN16038	160 x 40	215,147	12	11/4,5	2	100
PTUN20060	200 x 60	318,320	2/26	11/4,5	2	25
PTUN20080	200 x 80	351,813	2/38	11/4,5	2	25
PTUN24060	240 x 60	442,510	2/32	11/4,5	2	25
PTUN24080	240 x 80	545,313	2/46	11/4,5	2	25

Anclajes para postes

AP

MADERA



CÓDIGO	MEDIDA	€/100	MÉTRICA	N° AGUJEROS	GROSOR	
APAR070	70 x 70 x 100 x 100	4.902,447	M20	8	5	1
APAR150	150 x 150 x 100 x 100	6.080,680	M20	8	5	1

AP-AR

Bicromatado de altura regulable



MADERA



CÓDIGO	MEDIDA	€/100	N° AGUJEROS	Ø ORIFICIOS	GROSOR	
APAT071	71 x 200 x 60 x 50	2.579,867	6	10,5	4	1
APAT091	91 x 200 x 60 x 50	2.885,730	6	10,5	4	1
APAT101	101 x 200 x 60 x 50	2.985,290	6	10,5	4	1

AP-AT

En "U" para atornillar directamente o sobre espárragos

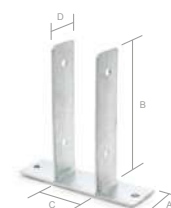

MADERA



CÓDIGO	MEDIDA	€/100	ØD(MM)	N° AGUJEROS	Ø ORIFICIOS	GROSOR	
APFL801020	80 x 100 x 200 x 60	2.060,183	19	3	11	4	1

AP-FL

En "L", soldado y con pata de acero corrugado

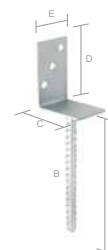

MADERA



CÓDIGO	MEDIDA	€/100	N° AGUJEROS	Ø ORIFICIOS	GROSOR	
APFUZ100	60-140 x 115 x 100 x 70	4.843,247	3/4	11/7	4,5	1

AP-FU Z

Cincado en "U" con ancho regulable



MADERA



CÓDIGO	MEDIDA	€/100	N° AGUJEROS	Ø ORIFICIOS	GROSOR	
APPD100	100 x 100 x 150 x 43	5.032,520	8	10,5	5	1

AP-PD

Desigual



AP

Anclajes para postes

AP-PG

Igual



CÓDIGO	MEDIDA	€/100	Nº AGUJEROS	Ø ORIFICIOS	GROSOR	
APPG070	70 x 90 x 70 x 80 x 90	4.410,133	8	8,5	5	1
APPG100	100 x 100 x 100 x 100 x 100	5.262,567	8	10,5	5	1

AP-PT

En "U" soldado con pata de acero corrugada

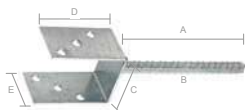

CÓDIGO	MEDIDA	€/100	ØD(MM)	Nº AGUJEROS	Ø ORIFICIOS	GROSOR	
APPT071	71 x 100 x 200 x 60	2.443,667	19	6	10,5	4	1
APPT091	91 x 100 x 200 x 60	2.561,160	19	6	10,5	4	1
APPT101	101 x 100 x 200 x 60	2.615,907	19	6	10,5	4	1

AP-UE Z

Cincado en "U" para empotrar con ancho regulable

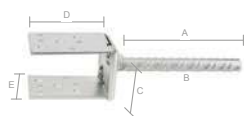

CÓDIGO	MEDIDA	€/100	Nº AGUJEROS	GROSOR	
APUEZ200	71-131 x 110 x 200 x 70	4.973,490	6	4,5	1

AP-SB

Sobre base



CÓDIGO	MEDIDA	€/100	Nº AGUJEROS	Ø ORIFICIOS	GROSOR	UD. MIN. VENTA	
APSB71	71 x 71 x 150	1.789,281	2	4 x 11	1,8	2	1
APSB91	91 x 91 x 150	2.166,148	2	4 x 11	1,8	2	1

AP-EN

Para enterrar



CÓDIGO	MEDIDA	€/100	Nº AGUJEROS	Ø ORIFICIOS	GROSOR	UD. MIN. VENTA	
APEN71	71 x 71 x 750	2.447,196	2	4 x 11	1,8	2	1
APEN91	91 x 91 x 750	2.752,280	2	4 x 11	1,8	2	1

VM-PF

Puntas de fijación ATLANTIS C3-M



CÓDIGO	MEDIDA	€/100	
VMPF050	4 x 50	28,630	200



TORNILLERÍA NORMALIZADA



A PE

DIN-933

Tornillo rosca métrica con cabeza hexagonal 8.8. Rosca completa

METAL



DIN-933

Cincado



Disponible en varios recubrimientos. Consulte precio y plazo de entrega.

CÓDIGO	MEDIDA	€/100				CÓDIGO	MEDIDA	€/100			
D93304008	M4 x 8	4,780	7	500	22.500	D93310100	M10 x 100	130,343	17	50	300
D93304010	M4 x 10	4,983	7	500	22.500	D93312020	M12 x 20	53,550	19	100	1.200
D93304012	M4 x 12	5,093	7	500	12.000	D93312025	M12 x 25	55,170	19	100	600
D93304016	M4 x 16	5,433	7	500	12.000	D93312030	M12 x 30	60,780	19	100	600
D93304020	M4 x 20	6,487	7	500	12.000	D93312035	M12 x 35	68,257	19	100	600
D93304025	M4 x 25	7,267	7	500	6.000	D93312040	M12 x 40	72,403	19	100	600
D93304030	M4 x 30	8,307	7	500	6.000	D93312045	M12 x 45	83,270	19	100	600
D93304035	M4 x 35	8,727	7	250	6.000	D93312050	M12 x 50	85,917	19	100	400
D93304040	M4 x 40	10,790	7	250	3.000	D93312060	M12 x 60	93,027	19	100	400
D93304045	M4 x 45	12,523	7	250	3.000	D93312070	M12 x 70	112,413	19	100	400
D93304050	M4 x 50	14,247	7	250	3.000	D93312080	M12 x 80	138,150	19	50	300
D93304060	M4 x 60	18,643	7	250	3.000	D93312090	M12 x 90	170,510	19	50	300
D93305010	M5 x 10	6,110	8	500	12.000	D93312100	M12 x 100	192,693	19	25	300
D93305012	M5 x 12	6,453	8	500	12.000	D93312110	M12 x 110	230,773	19	25	300
D93305016	M5 x 16	6,800	8	500	6.000	D93312120	M12 x 120	249,613	19	25	300
D93305020	M5 x 20	7,583	8	500	6.000	D93314030	M14 x 30	112,053	22	50	400
D93305025	M5 x 25	8,007	8	500	6.000	D93314035	M14 x 35	119,780	22	50	300
D93305030	M5 x 30	9,633	8	500	6.000	D93314040	M14 x 40	128,187	22	50	300
D93305035	M5 x 35	10,403	8	250	3.000	D93314045	M14 x 45	141,867	22	50	300
D93305040	M5 x 40	11,220	8	250	3.000	D93314050	M14 x 50	153,727	22	50	300
D93305045	M5 x 45	11,897	8	250	3.000	D93314060	M14 x 60	173,223	22	50	300
D93305050	M5 x 50	12,870	8	250	3.000	D93314070	M14 x 70	195,563	22	50	300
D93305060	M5 x 60	14,497	8	250	1.500	D93314080	M14 x 80	212,893	22	25	150
D93305070	M5 x 70	15,980	8	250	3.000	D93314090	M14 x 90	208,013	22	25	150
D93306010	M6 x 10	7,470	10	250	6.000	D93314100	M14 x 100	233,913	22	25	150
D93306012	M6 x 12	8,207	10	250	6.000	D93314110	M14 x 110	271,537	22	25	150
D93306016	M6 x 16	8,807	10	250	6.000	D93314120	M14 x 120	309,567	22	25	150
D93306020	M6 x 20	10,117	10	250	3.000	D93316030	M16 x 30	133,800	24	50	300
D93306025	M6 x 25	11,117	10	250	3.000	D93316035	M16 x 35	140,997	24	50	300
D93306030	M6 x 30	12,807	10	250	3.000	D93316040	M16 x 40	145,367	24	50	300
D93306035	M6 x 35	14,447	10	250	3.000	D93316045	M16 x 45	188,457	24	50	300
D93306040	M6 x 40	16,097	10	250	3.000	D93316050	M16 x 50	189,023	24	50	300
D93306045	M6 x 45	17,737	10	250	1.500	D93316060	M16 x 60	191,300	24	50	200
D93306050	M6 x 50	19,350	10	250	1.500	D93316070	M16 x 70	249,007	24	25	150
D93306060	M6 x 60	22,633	10	100	1.200	D93316080	M16 x 80	271,943	24	25	150
D93306065	M6 x 65	23,917	10	100	600	D93316090	M16 x 90	289,260	24	25	150
D93306070	M6 x 70	26,800	10	100	1.200	D93316100	M16 x 100	295,920	24	25	150
D93308016	M8 x 16	18,013	13	200	2.400	D93316110	M16 x 110	414,077	24	25	150
D93308020	M8 x 20	19,870	13	200	1.600	D93316120	M16 x 120	435,737	24	25	150
D93308025	M8 x 25	23,017	13	200	1.600	D93318030	M18 x 30	243,617	27	25	150
D93308030	M8 x 30	26,577	13	200	1.200	D93318035	M18 x 35	251,107	27	25	300
D93308035	M8 x 35	27,657	13	200	1.200	D93318040	M18 x 40	265,030	27	25	300
D93308040	M8 x 40	26,060	13	200	1.200	D93318045	M18 x 45	275,577	27	25	300
D93308045	M8 x 45	30,250	13	200	1.200	D93318050	M18 x 50	286,647	27	25	150
D93308050	M8 x 50	33,027	13	200	800	D93318060	M18 x 60	316,727	27	25	150
D93308060	M8 x 60	39,650	13	200	800	D93318070	M18 x 70	382,517	27	25	150
D93308070	M8 x 70	50,103	13	200	800	D93318080	M18 x 80	411,643	27	25	150
D93308080	M8 x 80	64,960	13	100	600	D93318090	M18 x 90	536,647	27	25	150
D93308090	M8 x 90	81,700	13	100	600	D93318100	M18 x 100	602,433	27	25	150
D93308100	M8 x 100	89,823	13	100	400	D93318110	M18 x 110	676,957	27	25	100
D93308110	M8 x 110	175,047	13	100	400	D93318120	M18 x 120	751,433	27	25	100
D93308120	M8 x 120	176,133	13	100	400	D93320030	M20 x 30	247,947	30	25	150
D93310016	M10 x 16	33,857	17	200	1.200	D93320035	M20 x 35	255,650	30	25	150
D93310020	M10 x 20	34,250	17	200	1.200	D93320040	M20 x 40	314,147	30	25	150
D93310025	M10 x 25	39,800	17	200	1.200	D93320045	M20 x 45	285,433	30	25	150
D93310030	M10 x 30	45,093	17	200	800	D93320050	M20 x 50	293,607	30	25	150
D93310035	M10 x 35	48,190	17	200	1.200	D93320060	M20 x 60	361,123	30	25	150
D93310040	M10 x 40	49,647	17	200	800	D93320070	M20 x 70	399,650	30	25	100
D93310045	M10 x 45	56,163	17	200	800	D93320080	M20 x 80	438,543	30	10	120
D93310050	M10 x 50	59,853	17	200	800	D93320090	M20 x 90	536,647	30	10	60
D93310060	M10 x 60	66,667	17	100	600	D93320100	M20 x 100	604,873	30	10	60
D93310070	M10 x 70	75,790	17	100	400	D93320110	M20 x 110	833,860	30	10	60
D93310080	M10 x 80	88,263	17	100	400	D93320120	M20 x 120	870,263	30	10	60
D93310090	M10 x 90	118,493	17	50	300						



BLISTER Y CAJA VENTANA
Siguiente página





Blister

CÓDIGO	MEDIDA	€/BOLSA	PCS.	BOLSAS
BZ3Z04008	M4 x 8	2,029	6	20
BZ3Z04010	M4 x 10	2,029	6	20
BZ3Z04012	M4 x 12	2,029	6	20
BZ3Z04016	M4 x 16	2,029	6	20
BZ3Z04020	M4 x 20	2,029	6	20
BZ3Z04025	M4 x 25	2,029	6	20
BZ3Z04030	M4 x 30	2,029	6	20
BZ3Z04035	M4 x 35	2,029	6	20
BZ3Z04040	M4 x 40	2,029	6	20
BZ3Z04045	M4 x 45	2,029	6	20
BZ3Z04050	M4 x 50	2,029	6	20
BZ3Z04060	M4 x 60	2,029	6	20
BZ3Z05010	M5 x 10	2,029	6	20
BZ3Z05012	M5 x 12	2,029	6	20
BZ3Z05015	M5 x 15	2,029	6	20
BZ3Z05016	M5 x 16	2,029	6	20
BZ3Z05020	M5 x 20	2,029	6	20
BZ3Z05025	M5 x 25	2,029	6	20
BZ3Z05030	M5 x 30	2,029	6	20
BZ3Z05035	M5 x 35	2,029	6	20
BZ3Z05040	M5 x 40	2,029	6	20
BZ3Z05045	M5 x 45	2,029	6	20
BZ3Z05050	M5 x 50	2,029	6	20
BZ3Z05060	M5 x 60	2,029	6	20
BZ3Z06016	M6 x 16	2,029	6	20
BZ3Z06020	M6 x 20	2,029	6	20
BZ3Z06025	M6 x 25	2,029	6	20
BZ3Z06030	M6 x 30	2,029	6	20
BZ3Z06040	M6 x 40	2,029	6	20
BZ3Z06050	M6 x 50	2,029	6	20
BZ3Z06060	M6 x 60	2,029	4	20
BZ3Z06070	M6 x 70	2,029	4	20
BZ3Z08016	M8 x 16	2,029	4	20
BZ3Z08020	M8 x 20	2,029	4	20
BZ3Z08025	M8 x 25	2,029	4	20
BZ3Z08030	M8 x 30	2,029	4	20
BZ3Z08040	M8 x 40	2,029	4	20
BZ3Z08050	M8 x 50	2,029	4	20
BZ3Z08060	M8 x 60	2,029	4	20
BZ3Z08070	M8 x 70	2,029	4	20
BZ3Z08080	M8 x 80	2,029	4	20
BZ3Z10030	M10 x 30	2,029	2	20
BZ3Z10040	M10 x 40	2,029	2	20
BZ3Z10050	M10 x 50	2,029	2	20



Caja con Ventana

CÓDIGO	MEDIDA	€/CAJA	PCS.	CAJAS
VD93304008	M4 x 8	5,805	100	8
VD93304010	M4 x 10	6,050	100	8
VD93304012	M4 x 12	6,178	100	8
VD93304016	M4 x 16	6,592	100	8
VD93304020	M4 x 20	7,592	100	8
VD93304025	M4 x 25	7,056	80	8
VD93304030	M4 x 30	7,488	80	8
VD93304040	M4 x 40	6,082	50	8
VD93304050	M4 x 50	6,664	40	8
VD93304060	M4 x 60	9,862	40	8
VD93305010	M5 x 10	6,888	100	8
VD93305012	M5 x 12	5,818	80	8
VD93305016	M5 x 16	6,368	80	8
VD93305020	M5 x 20	6,214	70	8
VD93305025	M5 x 25	6,251	60	8
VD93305030	M5 x 30	5,009	40	8
VD93305040	M5 x 40	4,800	30	8
VD93305050	M5 x 50	4,076	15	8
VD93305060	M5 x 60	4,294	15	8
VD93305070	M5 x 70	3,949	10	8
VD93306016	M6 x 16	5,227	50	8
VD93306020	M6 x 20	5,924	50	8
VD93306025	M6 x 25	5,860	45	8
VD93306030	M6 x 30	5,992	40	8
VD93306040	M6 x 40	5,651	30	8
VD93306050	M6 x 50	4,076	15	8
VD93306060	M6 x 60	4,586	15	8
VD93306070	M6 x 70	5,227	15	8
VD93308016	M8 x 16	8,567	40	8
VD93308020	M8 x 20	8,348	35	8
VD93308025	M8 x 25	8,079	30	8
VD93308030	M8 x 30	7,780	25	8
VD93308040	M8 x 40	6,191	20	8
VD93308050	M8 x 50	5,886	15	8
VD93308060	M8 x 60	7,065	15	8
VD93308070	M8 x 70	8,793	15	8
VD93308080	M8 x 80	7,601	10	8
VD93308100	M8 x 100	10,122	10	8
VD93310020	M10 x 20	6,159	15	8
VD93310030	M10 x 30	7,916	15	8
VD93310040	M10 x 40	5,809	10	8
VD93310050	M10 x 50	7,006	10	8
VD93310060	M10 x 60	7,802	10	8
VD93310070	M10 x 70	8,866	10	8
VD93310080	M10 x 80	10,327	10	8
VD93312030	M12 x 30	7,106	10	8
VD93312040	M12 x 40	6,946	8	8
VD93312050	M12 x 50	6,033	6	8
VD93312060	M12 x 60	6,701	6	8
VD93312070	M12 x 70	7,893	6	8
VD93312080	M12 x 80	9,698	6	8



Disponible en varios recubrimientos. Consulte precio y plazo de entrega.



Más gama página anterior

DIN-933

Tornillo rosca métrica con cabeza hexagonal 8.8. Rosca completa

INOXIDABLE



DIN-933 A2

Inoxidable A2



CÓDIGO	MEDIDA	€/100			
D933IM04010	M4 x 10	12,083	7	500	12.000
D933IM04016	M4 x 16	14,473	7	500	12.000
D933IM04020	M4 x 20	16,650	7	500	8.000
D933IM04025	M4 x 25	17,960	7	500	8.000
D933IM04030	M4 x 30	20,573	7	500	6.000
D933IM04035	M4 x 35	25,250	7	250	6.000
D933IM04040	M4 x 40	28,077	7	250	6.000
D933IM05010	M5 x 10	12,627	8	500	8.000
D933IM05016	M5 x 16	14,800	8	500	-
D933IM05020	M5 x 20	16,760	8	500	6.000
D933IM05025	M5 x 25	19,263	8	500	4.000
D933IM05030	M5 x 30	22,310	8	500	4.000
D933IM05035	M5 x 35	24,707	8	250	3.000
D933IM05040	M5 x 40	27,753	8	250	3.000
D933IM05050	M5 x 50	33,960	8	250	3.000
D933IM06010	M6 x 10	21,180	10	250	6.000
D933IM06016	M6 x 16	22,437	10	250	4.000
D933IM06020	M6 x 20	25,993	10	250	4.000
D933IM06025	M6 x 25	27,007	10	250	3.000
D933IM06030	M6 x 30	31,380	10	250	3.000
D933IM06035	M6 x 35	35,483	10	250	2.000
D933IM06040	M6 x 40	39,223	10	250	2.000
D933IM06050	M6 x 50	46,547	10	250	1.500
D933IM08016	M8 x 16	41,407	13	200	1.600
D933IM08020	M8 x 20	44,880	13	200	1.600
D933IM08025	M8 x 25	50,663	13	200	1.600
D933IM08030	M8 x 30	56,327	13	200	1.200
D933IM08035	M8 x 35	61,977	13	200	1.200
D933IM08040	M8 x 40	68,413	13	200	1.200
D933IM08050	M8 x 50	82,320	13	200	800
D933IM08060	M8 x 60	93,953	13	200	800
D933IM08070	M8 x 70	112,587	13	200	800
D933IM08080	M8 x 80	128,683	13	100	600
D933IM08090	M8 x 90	142,570	13	100	600
D933IM08100	M8 x 100	159,967	13	100	600
D933IM10020	M10 x 20	84,357	17	200	800
D933IM10025	M10 x 25	88,470	17	200	800
D933IM10030	M10 x 30	96,950	17	200	800
D933IM10035	M10 x 35	105,697	17	200	800

CÓDIGO	MEDIDA	€/100			
D933IM10040	M10 x 40	111,617	17	200	-
D933IM10050	M10 x 50	132,967	17	200	-
D933IM10060	M10 x 60	152,267	17	100	600
D933IM10070	M10 x 70	171,757	17	100	400
D933IM10080	M10 x 80	202,097	17	100	400
D933IM10090	M10 x 90	227,687	17	50	300
D933IM10100	M10 x 100	256,903	17	50	300
D933IM12020	M12 x 20	138,480	19	100	600
D933IM12030	M12 x 30	144,040	19	100	600
D933IM12040	M12 x 40	162,333	19	100	400
D933IM12050	M12 x 50	187,337	19	100	400
D933IM12060	M12 x 60	213,523	19	100	400
D933IM12070	M12 x 70	239,983	19	100	-
D933IM12080	M12 x 80	299,853	19	50	300
D933IM12090	M12 x 90	328,287	19	50	300
D933IM12100	M12 x 100	356,733	19	25	150
D933IM14030	M14 x 30	271,427	22	50	300
D933IM14040	M14 x 40	297,273	22	50	300
D933IM14050	M14 x 50	338,637	22	50	300
D933IM14060	M14 x 60	385,163	22	50	200
D933IM14070	M14 x 70	429,107	22	50	200
D933IM14080	M14 x 80	460,923	22	25	150
D933IM14100	M14 x 100	632,190	22	25	150
D933IM16030	M16 x 30	299,723	24	50	300
D933IM16040	M16 x 40	311,187	24	50	200
D933IM16050	M16 x 50	354,900	24	50	200
D933IM16060	M16 x 60	403,760	24	50	200
D933IM16070	M16 x 70	450,050	24	25	150
D933IM16080	M16 x 80	498,910	24	25	150
D933IM16090	M16 x 90	588,760	24	25	150
D933IM16100	M16 x 100	637,770	24	25	100
D933IM18030	M18 x 30	599,210	27	25	100
D933IM18040	M18 x 40	633,757	27	25	200
D933IM18050	M18 x 50	692,297	27	25	150
D933IM18060	M18 x 60	773,733	27	25	150
D933IM18070	M18 x 70	860,250	27	25	100
D933IM18080	M18 x 80	941,717	27	25	100
D933IM18090	M18 x 90	1.023,167	27	25	100
D933IM18100	M18 x 100	1.104,613	27	25	100



Blister

CÓDIGO	MEDIDA	€/BOLSA	PCS.	BOLSAS
BZ3I04010	M4 x 10	2,565	6	20
BZ3I04016	M4 x 16	2,565	6	20
BZ3I04020	M4 x 20	2,565	6	20
BZ3I04030	M4 x 30	2,565	6	20
BZ3I04040	M4 x 40	2,565	6	20
BZ3I05010	M5 x 10	2,565	6	20
BZ3I05016	M5 x 16	2,565	6	20
BZ3I05020	M5 x 20	2,565	6	20
BZ3I05025	M5 x 25	2,277	6	20
BZ3I05030	M5 x 30	2,565	6	20
BZ3I05040	M5 x 40	2,565	6	20
BZ3I05050	M5 x 50	2,565	6	20
BZ3I06016	M6 x 16	2,565	6	20
BZ3I06020	M6 x 20	2,565	6	20
BZ3I06025	M6 x 25	2,565	6	20
BZ3I06030	M6 x 30	2,565	6	20
BZ3I06040	M6 x 40	2,565	6	20
BZ3I06050	M6 x 50	2,565	6	20
BZ3I08016	M8 x 16	2,565	4	20
BZ3I08020	M8 x 20	2,565	4	20
BZ3I08025	M8 x 25	2,565	4	20
BZ3I08030	M8 x 30	2,565	4	20
BZ3I08040	M8 x 40	2,565	4	20
BZ3I08050	M8 x 50	2,565	4	20
BZ3I08060	M8 x 60	2,565	4	20
BZ3I10020	M10 x 20	2,565	2	20
BZ3I10030	M10 x 30	2,565	2	20
BZ3I10040	M10 x 40	2,565	2	20



Caja con Ventana

CÓDIGO	MEDIDA	€/CAJA	PCS.	CAJAS
VD933I04010	M4 x 10	5,951	40	8
VD933I04016	M4 x 16	7,130	40	8
VD933I04020	M4 x 20	7,905	40	8
VD933I04030	M4 x 30	7,601	30	8
VD933I04040	M4 x 40	8,328	25	8
VD933I05010	M5 x 10	6,222	40	8
VD933I05016	M5 x 16	7,294	40	8
VD933I05020	M5 x 20	8,258	40	8
VD933I05030	M5 x 30	5,495	20	8
VD933I05040	M5 x 40	6,838	20	8
VD933I05050	M5 x 50	4,390	10	8
VD933I06010	M6 x 10	7,828	30	8
VD933I06016	M6 x 16	7,983	30	8
VD933I06020	M6 x 20	9,251	30	8
VD933I06025	M6 x 25	8,009	25	8
VD933I06030	M6 x 30	9,307	25	8
VD933I06040	M6 x 40	7,249	15	8
VD933I06050	M6 x 50	5,733	10	8
VD933I08016	M8 x 16	10,201	20	8
VD933I08020	M8 x 20	11,054	20	8
VD933I08025	M8 x 25	12,481	20	8
VD933I08030	M8 x 30	10,408	15	8
VD933I08040	M8 x 40	8,428	10	8
VD933I08050	M8 x 50	10,138	10	8
VD933I08060	M8 x 60	11,573	10	8
VD933I10020	M10 x 20	10,390	10	8
VD933I10030	M10 x 30	11,943	10	8
VD933I10040	M10 x 40	13,749	10	8
VD933I10050	M10 x 50	16,378	10	8
VD933I10060	M10 x 60	18,755	10	8



Tornillo rosca métrica con cabeza hexagonal 8.8. Rosca media

DIN-931

METAL



Disponible en varios recubrimientos. Consulte precio y plazo de entrega.

CÓDIGO	MEDIDA	€/100			
D931806030	M6 x 30	12,850	10	250	3.000
D931806035	M6 x 35	15,230	10	250	2.000
D931806040	M6 x 40	16,340	10	250	2.000
D931806045	M6 x 45	18,393	10	250	2.000
D931806050	M6 x 50	19,517	10	250	1.500
D931806060	M6 x 60	23,730	10	100	1.200
D931806070	M6 x 70	30,250	10	100	1.200
D931808030	M8 x 30	26,407	13	200	1.200
D931808035	M8 x 35	27,947	13	200	1.200
D931808040	M8 x 40	29,770	13	200	1.200
D931808045	M8 x 45	32,883	13	200	1.200
D931808050	M8 x 50	34,900	13	250	1.000
D931808060	M8 x 60	41,103	13	250	-
D931808070	M8 x 70	50,747	13	250	-
D931808080	M8 x 80	66,407	13	100	600
D931808090	M8 x 90	82,783	13	100	600
D931808100	M8 x 100	89,160	13	100	600
D931808110	M8 x 110	95,567	13	100	400
D931808120	M8 x 120	105,950	13	100	400
D931808130	M8 x 130	116,467	13	50	400
D931808140	M8 x 140	120,413	13	50	400
D931808150	M8 x 150	128,003	13	50	400
D931810035	M10 x 35	50,297	17	200	800
D931810040	M10 x 40	51,777	17	200	-
D931810045	M10 x 45	58,333	17	200	-
D931810050	M10 x 50	68,110	17	200	-
D931810060	M10 x 60	69,313	17	100	600
D931810070	M10 x 70	77,317	17	100	400
D931810080	M10 x 80	91,140	17	100	400
D931810090	M10 x 90	106,607	17	50	300
D931810100	M10 x 100	118,410	17	50	300
D931810110	M10 x 110	133,493	17	50	300
D931810120	M10 x 120	144,020	17	50	300
D931810130	M10 x 130	155,867	17	50	200
D931810140	M10 x 140	159,670	17	50	200
D931810150	M10 x 150	173,330	17	25	200
D931812040	M12 x 40	73,823	19	100	400
D931812045	M12 x 45	84,403	19	100	400
D931812050	M12 x 50	92,717	19	100	400
D931812060	M12 x 60	96,020	19	100	400
D931812070	M12 x 70	112,723	19	100	400
D931812080	M12 x 80	136,653	19	50	300
D931812090	M12 x 90	141,443	19	50	200
D931812100	M12 x 100	154,697	19	25	200
D931812110	M12 x 110	180,797	19	25	200
D931812120	M12 x 120	194,447	19	25	200

CÓDIGO	MEDIDA	€/100			
D931812130	M12 x 130	214,683	19	25	200
D931812140	M12 x 140	225,353	19	25	-
D931812150	M12 x 150	236,410	19	10	120
D931814050	M14 x 50	151,220	22	50	300
D931814060	M14 x 60	171,747	22	50	200
D931814070	M14 x 70	192,650	22	50	200
D931814080	M14 x 80	210,930	22	25	150
D931814090	M14 x 90	252,640	22	25	150
D931814100	M14 x 100	291,617	22	25	150
D931814110	M14 x 110	320,007	22	25	150
D931814120	M14 x 120	326,277	22	25	150
D931814130	M14 x 130	333,477	22	25	100
D931814140	M14 x 140	341,227	22	25	100
D931814150	M14 x 150	360,663	22	10	120
D931816050	M16 x 50	188,523	24	50	200
D931816060	M16 x 60	192,477	24	50	200
D931816070	M16 x 70	201,150	24	25	150
D931816080	M16 x 80	224,340	24	25	150
D931816090	M16 x 90	247,460	24	25	150
D931816100	M16 x 100	294,310	24	25	100
D931816110	M16 x 110	324,250	24	25	100
D931816120	M16 x 120	346,637	24	25	100
D931816130	M16 x 130	365,690	24	25	100
D931816140	M16 x 140	376,050	24	25	100
D931816150	M16 x 150	416,637	24	10	80
D931818060	M18 x 60	344,900	27	25	150
D931818070	M18 x 70	359,260	27	25	100
D931818080	M18 x 80	405,810	27	25	100
D931818090	M18 x 90	416,073	27	25	100
D931818100	M18 x 100	453,757	27	25	100
D931818110	M18 x 110	481,223	27	10	80
D931818120	M18 x 120	543,390	27	10	80
D931818130	M18 x 130	717,950	27	10	80
D931818140	M18 x 140	766,370	27	10	80
D931818150	M18 x 150	815,010	27	10	-
D931820060	M20 x 60	356,210	30	25	100
D931820070	M20 x 70	394,533	30	25	100
D931820080	M20 x 80	434,847	30	25	100
D931820090	M20 x 90	527,727	30	25	150
D931820100	M20 x 100	606,970	30	25	-
D931820110	M20 x 110	681,037	30	10	-
D931820120	M20 x 120	735,533	30	10	-
D931820130	M20 x 130	786,990	30	10	-
D931820140	M20 x 140	838,160	30	10	60
D931820150	M20 x 150	892,107	30	5	30



Blister

CÓDIGO	MEDIDA	€/BOLSA	PCS. 	BOLSAS
BZ93106030	M6 x 30	2,029	6	20
BZ93106040	M6 x 40	2,029	6	20
BZ93106050	M6 x 50	2,029	6	20
BZ93106060	M6 x 60	2,029	4	20
BZ93106070	M6 x 70	2,029	4	20
BZ93108030	M8 x 30	2,029	4	20
BZ93108040	M8 x 40	2,029	4	20
BZ93108050	M8 x 50	2,029	4	20
BZ93108060	M8 x 60	2,029	4	20
BZ93108070	M8 x 70	2,029	4	20
BZ93108080	M8 x 80	2,029	4	20



Caja con Ventana

CÓDIGO	MEDIDA	€/CAJA	PCS. 	CAJAS
VD93106030	M6 x 30	6,809	40	8
VD93106040	M6 x 40	6,493	30	8
VD93106050	M6 x 50	4,303	15	8
VD93106060	M6 x 60	4,813	15	8
VD93106070	M6 x 70	5,728	15	8
VD93108030	M8 x 30	8,166	25	8
VD93108040	M8 x 40	7,098	20	8
VD93108050	M8 x 50	6,241	15	8
VD93108060	M8 x 60	7,350	15	8
VD93108070	M8 x 70	9,013	15	8
VD93108080	M8 x 80	7,918	10	8
VD93110040	M10 x 40	6,552	10	8
VD93110050	M10 x 50	8,121	10	8
VD93110060	M10 x 60	8,265	10	8
VD93110070	M10 x 70	9,215	10	8
VD93110080	M10 x 80	10,864	10	8
VD93112050	M10 x 50	6,633	6	8
VD93112060	M10 x 60	7,165	6	8
VD93112070	M10 x 70	8,062	6	8
VD93112080	M10 x 80	9,774	6	8

DIN-6921

Tornillo cabeza hexagonal con arandela estampada y grafilada 8.8

DIN-6921

METAL



Disponible en varios recubrimientos. Consulte precio y plazo de entrega.

CÓDIGO	MEDIDA	€/100			
D692105010	M5 x 10	9,203	8	500	6.000
D692105012	M5 x 12	10,020	8	500	4.000
D692105016	M5 x 16	11,227	8	500	4.000
D692105020	M5 x 20	11,520	8	500	3.000
D692105025	M5 x 25	13,307	8	500	3.000
D692105030	M5 x 30	15,537	8	500	3.000
D692106010	M6 x 10	13,600	10	250	-
D692106012	M6 x 12	14,013	10	250	3.000
D692106016	M6 x 16	15,250	10	250	3.000
D692106020	M6 x 20	16,810	10	250	3.000
D692106025	M6 x 25	18,797	10	250	2.000
D692106030	M6 x 30	21,810	10	250	2.000
D692106035	M6 x 35	22,270	10	250	1.500
D692108012	M8 x 12	27,003	13	200	1.600
D692108016	M8 x 16	28,073	13	200	1.600
D692108020	M8 x 20	28,677	13	200	-
D692108025	M8 x 25	33,407	13	200	-
D692108030	M8 x 30	37,123	13	200	1.200
D692108035	M8 x 35	41,310	13	200	1.200
D692108040	M8 x 40	42,960	13	200	800
D692108050	M8 x 50	46,867	13	200	800
D692108060	M8 x 60	49,280	13	200	600
D692110020	M10 x 20	51,527	15	200	800
D692110025	M10 x 25	55,137	15	200	800
D692110030	M10 x 30	60,010	15	200	800
D692110035	M10 x 35	63,957	15	200	-
D692110040	M10 x 40	70,987	15	200	-
D692110050	M10 x 50	79,160	15	200	-
D692112025	M12 x 25	83,247	16	100	-
D692112030	M12 x 30	89,513	16	100	400
D692112035	M12 x 35	97,640	16	100	400
D692112040	M12 x 40	102,780	16	100	400
D692112045	M12 x 45	115,840	16	100	400
D692112050	M12 x 50	119,407	16	100	-
D692112060	M12 x 60	136,017	16	100	-

NEW DIN-6921 A2

Tornillo DIN-6921. Tornillo hexagonal con arandela estampada y grafilada. Inoxidable A2



METAL



CÓDIGO	MEDIDA	€/100	LLAVE DE INSTALACIÓN		
6921108020	M8 x 20	46,040	13	200	2.400
6921108050	M8 x 50	87,807	13	100	600
6921108070	M8 x 70	112,967	13	100	600

METAL



Disponible en varios
recubrimientos.
Consulte precio y plazo de entrega.

CÓDIGO	MEDIDA	€/100			
D91204008	M4 x 8	6,777	3	500	22.500
D91204010	M4 x 10	6,907	3	500	12.000
D91204012	M4 x 12	8,780	3	500	12.000
D91204016	M4 x 16	9,083	3	500	12.000
D91204020	M4 x 20	9,310	3	500	6.000
D91204025	M4 x 25	10,690	3	500	6.000
D91204030	M4 x 30	12,293	3	500	6.000
D91204035	M4 x 35	13,527	3	200	4.800
D91204040	M4 x 40	15,007	3	200	2.400
D91204045	M4 x 45	16,170	3	200	2.400
D91204050	M4 x 50	17,230	3	200	2.400
D91205008	M5 x 8	8,190	4	500	12.000
D91205010	M5 x 10	8,357	4	500	12.000
D91205012	M5 x 12	8,390	4	500	6.000
D91205016	M5 x 16	8,553	4	500	6.000
D91205020	M5 x 20	8,947	4	500	6.000
D91205025	M5 x 25	11,320	4	500	6.000
D91205030	M5 x 30	12,917	4	500	6.000
D91205035	M5 x 35	13,933	4	200	4.800
D91205040	M5 x 40	15,470	4	200	2.400
D91205045	M5 x 45	16,407	4	200	2.400
D91205050	M5 x 50	17,383	4	200	2.400
D91206010	M6 x 10	11,660	5	200	4.800
D91206012	M6 x 12	11,970	5	200	4.800
D91206016	M6 x 16	12,370	5	200	4.800
D91206020	M6 x 20	13,063	5	200	2.400
D91206025	M6 x 25	17,923	5	200	2.400
D91206030	M6 x 30	18,823	5	200	2.400
D91206035	M6 x 35	19,013	5	200	2.400
D91206040	M6 x 40	19,823	5	200	2.400
D91206045	M6 x 45	20,610	5	200	2.400
D91206050	M6 x 50	21,880	5	200	2.400
D91206060	M6 x 60	23,787	5	200	1.200
D91208010	M8 x 10	20,550	6	100	2.400
D91208012	M8 x 12	21,357	6	100	2.400
D91208016	M8 x 16	21,790	6	100	2.400
D91208020	M8 x 20	23,013	6	100	2.400

CÓDIGO	MEDIDA	€/100			
D91208025	M8 x 25	25,130	6	100	1.200
D91208030	M8 x 30	30,147	6	100	1.200
D91208035	M8 x 35	39,313	6	100	1.200
D91208040	M8 x 40	47,593	6	100	1.200
D91208045	M8 x 45	48,327	6	100	1.200
D91208050	M8 x 50	49,767	6	100	1.200
D91208060	M8 x 60	52,007	6	100	1.200
D91208070	M8 x 70	54,097	6	100	600
D91208080	M8 x 80	59,503	6	100	600
D91210016	M10 x 16	47,740	8	100	1.200
D91210020	M10 x 20	58,387	8	100	1.200
D91210025	M10 x 25	62,057	8	100	1.200
D91210030	M10 x 30	64,993	8	100	1.200
D91210035	M10 x 35	73,517	8	100	600
D91210040	M10 x 40	79,993	8	100	600
D91210045	M10 x 45	88,117	8	100	600
D91210050	M10 x 50	90,567	8	100	600
D91210060	M10 x 60	103,210	8	100	600
D91210070	M10 x 70	112,117	8	100	600
D91210080	M10 x 80	117,707	8	50	600
D91210090	M10 x 90	119,767	8	50	300
D91210100	M10 x 100	127,463	8	50	300
D91212020	M12 x 20	82,867	10	100	600
D91212025	M12 x 25	84,507	10	100	600
D91212030	M12 x 30	88,433	10	100	600
D91212035	M12 x 35	93,673	10	100	600
D91212040	M12 x 40	97,890	10	100	600
D91212045	M12 x 45	103,797	10	100	600
D91212050	M12 x 50	110,833	10	50	600
D91212060	M12 x 60	125,857	10	50	300
D91212070	M12 x 70	150,010	10	50	300
D91212080	M12 x 80	165,183	10	50	300
D91212090	M12 x 90	181,703	10	50	300
D91212100	M12 x 100	203,503	10	50	300
D91212110	M12 x 110	227,923	10	50	300
D91212120	M12 x 120	247,297	10	50	300



Caja con Ventana

CÓDIGO	MEDIDA	€/CAJA	PCS. 	CAJAS
VD91204010	M4 x 10	12,797	150	8
VD91204012	M4 x 12	13,996	125	8
VD91204020	M4 x 20	11,632	100	8
VD91204030	M4 x 30	6,436	40	8
VD91204040	M4 x 40	4,561	20	8
VD91204050	M4 x 50	6,789	20	8
VD91205010	M5 x 10	11,079	100	8
VD91205012	M5 x 12	11,194	100	8
VD91205016	M5 x 16	9,475	90	8
VD91205020	M5 x 20	8,039	70	8
VD91205025	M5 x 25	8,487	60	8
VD91205030	M5 x 30	7,217	40	8
VD91205040	M5 x 40	4,753	20	8
VD91205050	M5 x 50	5,121	20	8
VD91206010	M6 x 10	7,540	50	8
VD91206012	M6 x 12	7,328	50	8
VD91206016	M6 x 16	7,192	50	8
VD91206020	M6 x 20	8,155	50	8
VD91206025	M6 x 25	12,333	50	8
VD91206030	M6 x 30	8,749	35	8
VD91206040	M6 x 40	8,306	30	8
VD91206050	M6 x 50	4,980	15	8
VD91206060	M6 x 60	5,393	15	8
VD91208010	M8 x 10	8,145	30	8
VD91208016	M8 x 16	8,245	30	8
VD91208020	M8 x 20	8,376	30	8
VD91208030	M8 x 30	7,535	20	8
VD91208040	M8 x 40	11,940	20	8
VD91208050	M8 x 50	6,492	10	8
VD91208060	M8 x 60	6,799	10	8

METAL



Disponibile en varios recubrimientos. Consulte precio y plazo de entrega.

CÓDIGO	MEDIDA	€/100		
D603905016	M5 x 16	10,327	500	6.000
D603905020	M5 x 20	10,643	500	3.000
D603905025	M5 x 25	11,973	500	3.000
D603905030	M5 x 30	12,147	500	3.000
D603905035	M5 x 35	15,757	200	2.400
D603905040	M5 x 40	16,050	200	2.400
D603905045	M5 x 45	18,583	200	2.400
D603905050	M5 x 50	20,587	200	2.400
D603905060	M5 x 60	23,950	100	1.200
D603905070	M5 x 70	26,817	100	1.200
D603905080	M5 x 80	32,147	100	1.200
D603906016	M6 x 16	15,130	200	2.400
D603906020	M6 x 20	15,377	200	2.400
D603906025	M6 x 25	16,393	200	2.400
D603906030	M6 x 30	17,210	200	1.200
D603906035	M6 x 35	19,130	200	2.400
D603906040	M6 x 40	19,383	200	1.200
D603906045	M6 x 45	22,663	200	1.200
D603906050	M6 x 50	23,983	200	1.200
D603906060	M6 x 60	27,627	100	1.200
D603906070	M6 x 70	33,283	100	1.200
D603906080	M6 x 80	33,677	100	600
D603906090	M6 x 90	52,547	100	600
D603906100	M6 x 100	56,397	100	600
D603906110	M6 x 110	64,853	100	600
D603906120	M6 x 120	70,883	100	600
D603906130	M6 x 130	77,970	100	600
D603906140	M6 x 140	88,083	100	600
D603906150	M6 x 150	96,373	100	600
D603908016	M8 x 16	28,210	200	1.200
D603908020	M8 x 20	29,763	200	1.200
D603908025	M8 x 25	29,930	200	1.200
D603908030	M8 x 30	31,787	200	1.200
D603908035	M8 x 35	34,187	200	1.200
D603908040	M8 x 40	35,547	200	1.200
D603908045	M8 x 45	40,583	200	1.200
D603908050	M8 x 50	44,613	100	1.200
D603908060	M8 x 60	50,020	100	600
D603908070	M8 x 70	53,407	100	600
D603908080	M8 x 80	61,720	100	400
D603908090	M8 x 90	75,947	100	600
D603908100	M8 x 100	77,600	100	600
D603908110	M8 x 110	79,093	50	300



Blister

CÓDIGO	MEDIDA	€/BOLSA	PCS. 	BOLSAS
BZ603905020	M5 x 20	2,565	10	15
BZ603905030	M5 x 30	2,565	10	15
BZ603905040	M5 x 40	2,565	4	15
BZ603905050	M6 x 16	2,565	4	15
BZ603906016	M6 x 80	2,565	4	15
BZ603906020	M6 x 20	2,565	4	15
BZ603906030	M6 x 30	2,565	4	15
BZ603906040	M6 x 40	2,565	4	15
BZ603906050	M6 x 50	2,565	4	15
BZ603906060	M6 x 60	2,565	2	15
BZ603906070	M6 x 70	2,565	2	15
BZ603906080	M8 x 20	2,565	2	15
BZ603908025	M8 x 25	2,565	4	15
BZ603908030	M8 x 30	2,565	4	15
BZ603908040	M8 x 40	2,565	4	15
BZ603908050	M8 x 50	2,565	2	15
BZ603908060	M8 x 60	2,565	2	15
BZ603908070	M8 x 70	2,565	2	15
BZ603908080	M8 x 80	2,565	2	12
BZ603908090	M8 x 90	2,565	2	12
BZ603910025	M10 x 25	2,565	2	10
BZ603910030	M10 x 30	2,565	2	10
BZ603910040	M10 x 40	2,565	2	10
BZ603910050	M12 x 70	2,565	2	10



Caja con Ventana

CÓDIGO	MEDIDA	€/CAJA	PCS. 	CAJAS
VD603905020	M5 x 20	6,407	50	8
VD603905030	M5 x 30	6,430	40	8
VD603905040	M5 x 40	7,601	40	8
VD603905050	M5 x 50	8,853	35	8
VD603906016	M6 x 16	5,431	30	8
VD603906020	M6 x 20	5,497	30	8
VD603906030	M6 x 30	6,219	30	8
VD603906040	M6 x 40	5,844	25	8
VD603906050	M6 x 50	7,362	25	8
VD603906060	M6 x 60	8,487	25	8
VD603906070	M6 x 70	10,634	25	8
VD603906080	M6 x 80	8,272	20	8
VD603908025	M8 x 25	6,069	15	8
VD603908030	M8 x 30	6,331	15	8
VD603908040	M8 x 40	6,552	15	8
VD603908050	M8 x 50	8,220	15	8
VD603908060	M8 x 60	7,381	12	8
VD603908070	M8 x 70	6,561	10	8
VD603908080	M8 x 80	7,583	10	8
VD603908090	M8 x 90	9,420	10	8
VD603908100	M8 x 100	9,457	10	8
VD603910025	M10 x 25	9,678	15	8
VD603910030	M10 x 30	8,421	10	8
VD603910040	M10 x 40	8,741	10	8
VD603910050	M10 x 50	8,871	8	8
VD603910060	M10 x 60	10,137	8	8
VD603910070	M10 x 70	10,479	8	8
VD603910080	M10 x 80	11,941	8	8

Tornillo con cabeza redonda con cuello cuadrado y tuerca hexagonal

DIN-603/934

METAL



CÓDIGO	MEDIDA	€/100		
D603I08016	M8 x 16	42,047	200	2.400

DIN-603 A2 NEW

Tornillo DIN-603. Cabeza redonda y cuello cuadrado. Inoxidable A2



Tornillo arado con cabeza avellanada 8.8. Con tuerca

DIN-608

METAL



CÓDIGO	MEDIDA	€/100		
D60810035	10 x 35	71,177	100	600
D60810040	10 x 40	73,433	100	600
D60810045	10 x 45	81,010	100	600
D60810050	10 x 50	86,257	100	400
D60810060	10 x 60	101,120	100	400
D60811040	11 x 40	83,050	50	300
D60811045	11 x 45	91,507	50	300
D60811050	11 x 50	97,210	50	300
D60811060	11 x 60	114,363	50	300
D60811070	11 x 70	128,287	50	300

CÓDIGO	MEDIDA	€/100		
D60811080	11 x 80	144,837	50	200
D60811090	11 x 90	160,590	50	200
D60812040	12 x 40	101,787	50	300
D60812045	12 x 45	107,070	50	300
D60812050	12 x 50	113,027	50	300
D60812060	12 x 60	130,393	50	200
D60812070	12 x 70	144,797	50	200
D60812080	12 x 80	159,660	50	200
D60812090	12 x 90	179,107	50	200
D60812100	12 x 100	198,513	50	200



Disponible en varios recubrimientos. Consulte precio y plazo de entrega.

Tornillo ranurado, cabeza cilíndrica, 4.8

DIN-84

METAL



CÓDIGO	MEDIDA	€/100		
T0840304Z	M3 x 4	2,240	1.000	45.000
T0840306Z	M3 x 6	2,263	1.000	30.000
T0840308Z	M3 x 8	2,297	1.000	30.000
T0840310Z	M3 x 10	2,363	1.000	24.000
T0840312Z	M3 x 12	2,867	1.000	24.000
T0840316Z	M3 x 16	2,883	1.000	16.000
T0840320Z	M3 x 20	3,560	1.000	12.000
T0840325Z	M3 x 25	4,657	1.000	12.000
T0840330Z	M3 x 30	5,357	500	6.000
T0840335Z	M3 x 35	6,160	500	6.000
T0840340Z	M3 x 40	7,437	500	6.000
T0840406Z	M4 x 6	3,387	500	15.000
T0840408Z	M4 x 8	3,460	500	12.000
T0840410Z	M4 x 10	3,620	500	12.000
T0840412Z	M4 x 12	3,800	500	12.000
T0840416Z	M4 x 16	4,207	500	8.000
T0840420Z	M4 x 20	4,417	500	8.000
T0840425Z	M4 x 25	5,003	500	6.000
T0840435Z	M4 x 35	7,677	250	3.000
T0840445Z	M4 x 45	10,843	250	3.000
T0840450Z	M4 x 50	12,853	250	3.000
T0840460Z	M4 x 60	15,343	250	3.000
T0840470Z	M4 x 70	18,633	100	1.200
T0840506Z	M5 x 6	4,887	500	8.000

CÓDIGO	MEDIDA	€/100		
T0840508Z	M5 x 8	4,940	500	12.000
T0840510Z	M5 x 10	5,103	500	8.000
T0840512Z	M5 x 12	5,957	250	7.500
T0840516Z	M5 x 16	6,723	250	6.000
T0840520Z	M5 x 20	6,793	250	6.000
T0840525Z	M5 x 25	7,603	250	4.000
T0840530Z	M5 x 30	9,343	250	4.000
T0840535Z	M5 x 35	10,843	250	3.000
T0840540Z	M5 x 40	11,073	250	3.000
T0840545Z	M5 x 45	13,163	250	3.000
T0840550Z	M5 x 50	15,213	250	3.000
T0840560Z	M5 x 60	18,013	250	1.500
T0840608Z	M6 x 8	7,353	250	1.500
T0840610Z	M6 x 10	7,540	250	4.000
T0840616Z	M6 x 16	9,357	250	4.000
T0840620Z	M6 x 20	9,917	250	3.000
T0840625Z	M6 x 25	11,403	250	3.000
T0840630Z	M6 x 30	12,633	250	3.000
T0840635Z	M6 x 35	14,337	250	1.500
T0840640Z	M6 x 40	14,793	250	1.500
T0840645Z	M6 x 45	16,483	250	1.500
T0840650Z	M6 x 50	18,003	250	1.500
T0840660Z	M6 x 60	19,993	250	1.500



Disponible en varios recubrimientos. Consulte precio y plazo de entrega.

DIN-7985

Tornillo rosca métrica con cabeza alomada PH, 4.8

METAL



Disponible en varios recubrimientos. Consulte precio y plazo de entrega.

CÓDIGO	MEDIDA	€/100			
T9850306Z	M3 x 6	1,860	PH1	1.000	30.000
T9850308Z	M3 x 8	1,883	PH1	1.000	30.000
T9850310Z	M3 x 10	1,903	PH1	1.000	24.000
T9850312Z	M3 x 12	2,097	PH1	1.000	24.000
T9850316Z	M3 x 16	2,250	PH1	1.000	16.000
T9850320Z	M3 x 20	2,733	PH1	1.000	12.000
T9850325Z	M3 x 25	3,273	PH1	500	12.000
T9850330Z	M3 x 30	3,960	PH1	500	12.000
T9850406Z	M4 x 6	2,920	PH2	500	12.000
T9850408Z	M4 x 8	2,957	PH2	500	12.000
T9850410Z	M4 x 10	3,567	PH2	500	12.000
T9850412Z	M4 x 12	3,663	PH2	500	8.000
T9850416Z	M4 x 16	3,993	PH2	500	8.000
T9850420Z	M4 x 20	4,217	PH2	500	8.000
T9850425Z	M4 x 25	5,043	PH2	500	6.000
T9850430Z	M4 x 30	6,077	PH2	500	6.000
T9850435Z	M4 x 35	8,013	PH2	250	3.000
T9850440Z	M4 x 40	8,380	PH2	250	3.000
T9850450Z	M4 x 50	10,890	PH2	250	3.000
T9850506Z	M5 x 6	5,203	PH2	500	8.000
T9850508Z	M5 x 8	5,303	PH2	500	8.000

CÓDIGO	MEDIDA	€/100			
T9850510Z	M5 x 10	5,530	PH2	500	8.000
T9850512Z	M5 x 12	6,107	PH2	250	6.000
T9850516Z	M5 x 16	6,567	PH2	250	4.000
T9850520Z	M5 x 20	7,067	PH2	250	4.000
T9850525Z	M5 x 25	7,997	PH2	250	4.000
T9850530Z	M5 x 30	8,820	PH2	250	2.000
T9850535Z	M5 x 35	10,560	PH2	250	3.000
T9850540Z	M5 x 40	11,773	PH2	250	3.000
T9850545Z	M5 x 45	12,097	PH2	250	2.000
T9850550Z	M5 x 50	15,483	PH2	250	2.000
T9850608Z	M6 x 8	8,173	PH3	250	6.000
T9850610Z	M6 x 10	8,297	PH3	250	4.000
T9850612Z	M6 x 12	8,977	PH3	250	4.000
T9850616Z	M6 x 16	9,193	PH3	250	4.000
T9850620Z	M6 x 20	10,837	PH3	250	3.000
T9850625Z	M6 x 25	11,990	PH3	250	3.000
T9850630Z	M6 x 30	12,933	PH3	250	3.000
T9850635Z	M6 x 35	14,593	PH3	250	3.000
T9850640Z	M6 x 40	16,257	PH3	250	1.500
T9850650Z	M6 x 50	19,900	PH3	250	1.500
T9850660Z	M6 x 60	21,460	PH3	250	1.500



Blister

CÓDIGO	MEDIDA	€/BOLSA	PCS. 	BOLSAS
BZT9850306Z	M3 x 6	2,029	10	20
BZT9850310Z	M3 x 10	2,029	10	20
BZT9850316Z	M3 x 16	2,029	6	20
BZT9850320Z	M3 x 20	2,029	6	20
BZT9850330Z	M3 x 30	2,029	6	20
BZT9850416Z	M4 x 16	2,029	6	20
BZT9850420Z	M4 x 20	2,029	6	20
BZT9850430Z	M4 x 30	2,029	6	20
BZT9850510Z	M5 x 10	2,029	6	20
BZT9850520Z	M5 x 20	2,029	6	20
BZT9850525Z	M5 x 25	2,029	6	20
BZT9850530Z	M5 x 30	2,029	6	20
BZT9850540Z	M5 x 40	2,029	6	20
BZT9850610Z	M6 x 10	2,029	6	20
BZT9850616Z	M6 x 16	2,029	6	20
BZT9850620Z	M6 x 20	2,029	6	20
BZT9850625Z	M6 x 25	2,029	6	20
BZT9850630Z	M6 x 30	2,029	6	20
BZT9850640Z	M6 x 40	2,029	6	15
BZT9850650Z	M6 x 50	2,029	4	15
BZT9850660Z	M6 x 60	2,029	4	15



Caja con Ventana

CÓDIGO	MEDIDA	€/CAJA	PCS. 	CAJAS
VT9850306Z	M3 x 6	4,147	150	8
VT9850310Z	M3 x 10	4,403	150	8
VT9850316Z	M3 x 16	3,900	100	8
VT9850320Z	M3 x 20	4,151	100	8
VT9850330Z	M3 x 30	4,626	100	8
VT9850406Z	M4 x 6	4,172	100	8
VT9850408Z	M4 x 8	4,252	100	8
VT9850410Z	M4 x 10	4,479	100	8
VT9850416Z	M4 x 16	4,878	100	8
VT9850420Z	M4 x 20	5,155	100	8
VT9850506Z	M5 x 6	5,390	100	8
VT9850510Z	M5 x 10	5,637	100	8
VT9850512Z	M5 x 12	5,382	70	8
VT9850516Z	M5 x 16	5,508	70	8
VT9850520Z	M5 x 20	5,919	70	8
VT9850530Z	M5 x 30	5,470	50	8
VT9850540Z	M5 x 40	6,935	50	8
VT9850550Z	M5 x 50	9,067	50	8
VT9850610Z	M6 x 10	7,061	70	8
VT9850612Z	M6 x 12	7,530	70	8
VT9850616Z	M6 x 16	7,707	70	8
VT9850620Z	M6 x 20	7,753	50	8
VT9850630Z	M6 x 30	7,614	50	8
VT9850640Z	M6 x 40	9,567	50	8
VT9850650Z	M6 x 50	11,787	50	8
VT9850660Z	M6 x 60	12,627	50	8

Tornillo rosca métrica con cabeza avellanada ranurada,
4,8

DIN-963

METAL



CÓDIGO	MEDIDA	€/100		
T9630410Z	M4 x 10	3,020	500	22.500
T9630412Z	M4 x 12	3,187	500	22.500
T9630416Z	M4 x 16	3,267	500	12.000
T9630420Z	M4 x 20	3,413	500	12.000
T9630430Z	M4 x 30	4,910	500	6.000
T9630440Z	M4 x 40	6,203	250	3.000
T9630450Z	M4 x 50	9,203	250	3.000
T9630510Z	M5 x 10	3,450	500	12.000
T9630512Z	M5 x 12	4,093	500	12.000
T9630516Z	M5 x 16	4,250	250	7.500
T9630520Z	M5 x 20	4,953	250	6.000
T9630525Z	M5 x 25	6,153	250	6.000
T9630530Z	M5 x 30	6,350	250	4.000

CÓDIGO	MEDIDA	€/100		
T9630540Z	M5 x 40	9,803	250	3.000
T9630550Z	M5 x 50	11,857	250	3.000
T9630560Z	M5 x 60	14,303	250	1.500
T9630610Z	M6 x 10	5,577	250	11.250
T9630612Z	M6 x 12	5,817	250	11.250
T9630616Z	M6 x 16	6,153	250	6.000
T9630620Z	M6 x 20	7,200	250	4.000
T9630625Z	M6 x 25	8,103	250	3.000
T9630630Z	M6 x 30	9,203	250	3.000
T9630640Z	M6 x 40	11,370	250	1.500
T9630650Z	M6 x 50	12,907	250	1.500
T9630660Z	M6 x 60	14,270	250	1.500



Disponible en varios recubrimientos. Consulte precio y plazo de entrega.

Tornillo rosca métrica con cabeza avellanada PH, 4,8

DIN-965

METAL



CÓDIGO	MEDIDA	€/100			
T9650306Z	M3 x 6	2,053	PH1	1.000	45.000
T9650308Z	M3 x 8	2,053	PH1	1.000	45.000
T9650310Z	M3 x 10	2,053	PH1	1.000	30.000
T9650312Z	M3 x 12	2,250	PH1	1.000	24.000
T9650316Z	M3 x 16	2,593	PH1	500	22.500
T9650320Z	M3 x 20	3,050	PH1	500	22.500
T9650325Z	M3 x 25	3,700	PH1	500	12.000
T9650408Z	M4 x 8	3,087	PH2	500	22.500
T9650410Z	M4 x 10	3,190	PH2	500	12.000
T9650412Z	M4 x 12	3,360	PH2	500	22.500
T9650416Z	M4 x 16	3,497	PH2	500	12.000
T9650420Z	M4 x 20	3,960	PH2	500	12.000
T9650425Z	M4 x 25	4,363	PH2	500	6.000
T9650430Z	M4 x 30	5,290	PH2	500	6.000
T9650435Z	M4 x 35	6,247	PH2	500	6.000
T9650440Z	M4 x 40	7,197	PH2	250	3.000
T9650450Z	M4 x 50	8,370	PH2	250	3.000
T9650510Z	M5 x 10	4,827	PH2	250	11.250
T9650512Z	M5 x 12	5,190	PH2	250	11.250

CÓDIGO	MEDIDA	€/100			
T9650516Z	M5 x 16	5,550	PH2	250	6.000
T9650520Z	M5 x 20	6,167	PH2	250	6.000
T9650525Z	M5 x 25	6,937	PH2	250	6.000
T9650530Z	M5 x 30	7,760	PH2	250	4.000
T9650535Z	M5 x 35	8,937	PH2	250	6.000
T9650540Z	M5 x 40	9,823	PH2	250	3.000
T9650550Z	M5 x 50	12,750	PH2	250	3.000
T9650560Z	M5 x 60	16,037	PH2	250	1.500
T9650610Z	M6 x 10	7,213	PH3	250	6.000
T9650612Z	M6 x 12	7,357	PH3	250	6.000
T9650616Z	M6 x 16	7,910	PH3	250	6.000
T9650620Z	M6 x 20	9,053	PH3	250	4.000
T9650625Z	M6 x 25	10,030	PH3	250	3.000
T9650630Z	M6 x 30	11,213	PH3	250	3.000
T9650635Z	M6 x 35	12,490	PH3	250	3.000
T9650640Z	M6 x 40	13,770	PH3	250	1.500
T9650650Z	M6 x 50	16,650	PH3	250	1.500
T9650660Z	M6 x 60	19,737	PH3	100	1.200



Disponible en varios recubrimientos. Consulte precio y plazo de entrega.



Blister

CÓDIGO	MEDIDA	€/BOLSA	PCS.	BOLSAS
BZT9650410Z	M4 x 10	2,029	6	20
BZT9650420Z	M4 x 20	2,029	6	20
BZT9650430Z	M4 x 30	2,029	6	20
BZT9650510Z	M5 x 10	2,029	6	20
BZT9650520Z	M5 x 20	2,029	6	20
BZT9650525Z	M5 x 25	2,029	6	20
BZT9650530Z	M5 x 30	2,029	6	20
BZT9650620Z	M6 x 20	2,029	6	20
BZT9650630Z	M6 x 30	2,029	6	20
BZT9650640Z	M6 x 40	2,029	6	20



Caja con Ventana

CÓDIGO	MEDIDA	€/CAJA	PCS.	CAJAS
VT9650306Z	M3 x 6	5,145	200	8
VT9650310Z	M3 x 10	4,997	200	8
VT9650408Z	M4 x 8	3,907	100	8
VT9650410Z	M4 x 10	3,951	100	8
VT9650420Z	M4 x 20	4,824	100	8
VT9650425Z	M4 x 25	5,313	100	8
VT9650430Z	M4 x 30	6,438	100	8
VT9650416Z	M4 x 16	4,259	100	8
VT9650510Z	M5 x 10	4,115	70	8
VT9650516Z	M5 x 16	4,736	70	8
VT9650520Z	M5 x 20	5,257	70	8
VT9650530Z	M5 x 30	4,720	50	8
VT9650540Z	M5 x 40	5,983	50	8
VT9650610Z	M6 x 10	6,267	70	8
VT9650616Z	M6 x 16	6,739	70	8
VT9650620Z	M6 x 20	7,714	70	8
VT9650630Z	M6 x 30	6,823	50	8

DIN-934

Tuerca hexagonal

DIN-934

Cincada



Disponible en varios recubrimientos. Consulte precio y plazo de entrega.

METAL



CÓDIGO	MEDIDA	€/100	LLAVE DE INSTALACIÓN		
D93403	M3	1,597	5,5	500	22.500
D93404	M4	1,650	7	1.000	45.000
D93405	M5	2,143	8	500	12.000
D93406	M6	3,357	10	500	12.000
D93408	M8	6,000	13	250	6.000
D93410	M10	14,320	17	250	3.000
D93412	M12	22,633	19	250	1.500
D93414	M14	30,197	22	100	1.200
D93416	M16	44,917	24	100	600
D93418	M18	64,120	27	100	600
D93420	M20	74,713	30	50	600
D93422	M22	119,833	32	50	300
D93424	M24	168,113	36	25	300
D93427	M27	290,203	41	25	150
D93430	M30	385,367	46	25	150
D93433	M33	549,240	50	10	120
D93436	M36	582,967	55	10	60



Blister

CÓDIGO	MEDIDA	€/BOLSA	PCS.	BOLSAS
BZ934ZM03	M3	2,029	40	20
BZ934ZM04	M4	2,029	40	20
BZ934ZM05	M5	2,029	40	20
BZ934ZM06	M6	2,029	20	20
BZ934ZM08	M8	2,029	10	20
BZ934ZM10	M10	2,029	10	15
BZ934ZM12	M12	2,029	6	15



Caja con Ventana

CÓDIGO	MEDIDA	€/CAJA	PCS.	CAJAS
VD93403	M3	3,535	150	8
VD93404	M4	3,535	150	8
VD93405	M5	3,076	100	8
VD93406	M6	4,403	100	8
VD93408	M8	3,930	50	8
VD93410	M10	5,645	30	8
VD93412	M12	5,946	20	8

DIN-934 A2

Inoxidable A2



INOXIDABLE



CÓDIGO	MEDIDA	€/100	LLAVE DE INSTALACIÓN		
D934IM04	M4	4,447	7	500	22.500
D934IM05	M5	5,140	8	500	12.000
D934IM06	M6	8,483	10	500	12.000
D934IM08	M8	17,207	13	250	4.000
D934IM10	M10	38,387	17	250	2.000
D934IM12	M12	56,280	19	250	1.500
D934IM14	M14	80,893	22	100	800
D934IM16	M16	113,520	24	100	600
D934IM18	M18	180,550	27	100	600
D934IM20	M20	237,070	30	50	400
D934IM22	M22	327,683	32	50	300
D934IM24	M24	425,983	36	25	200



Blister

CÓDIGO	MEDIDA	€/BOLSA	PCS.	BOLSAS
BZ934IM04	M4	2,565	10	20
BZ934IM05	M5	2,565	8	20
BZ934IM06	M6	2,565	8	20
BZ934IM08	M8	2,565	6	20
BZ934IM10	M10	2,565	5	15



Caja con Ventana

CÓDIGO	MEDIDA	€/CAJA	PCS.	CAJAS
VD934IM04	M4	3,274	50	8
VD934IM05	M5	3,786	50	8
VD934IM06	M6	5,621	50	8
VD934IM08	M8	6,841	30	8
VD934IM10	M10	10,175	20	8

METAL



DIN-985

Cincada



Disponible en varios
recubrimientos.
Consulte precio y plazo de entrega.

CÓDIGO	MEDIDA	€/100	LLAVE DE INSTALACIÓN		
DZ98503	M3	2,957	5,5	500	22.500
DZ98504	M4	3,093	7	500	12.000
DZ98505	M5	3,313	8	500	12.000
DZ98506	M6	4,617	10	500	12.000
DZ98508	M8	8,250	13	250	6.000
DZ98510	M10	18,260	17	250	3.000
DZ98512	M12	28,747	19	100	1.200
DZ98514	M14	45,923	22	100	1.200
DZ98516	M16	55,973	24	50	600
DZ98518	M18	92,610	27	50	600
DZ98520	M20	116,433	30	25	300
DZ98522	M22	189,060	32	25	300
DZ98524	M24	229,783	36	25	300
DZ98527	M27	454,933	41	15	180
DZ98530	M30	769,710	46	15	90



Blister

CÓDIGO	MEDIDA	€/BOLSA	PCS. 	BOLSAS
BZZ98503	M3	2,029	20	20
BZZ98504	M4	2,029	20	20
BZZ98505	M5	2,029	20	20
BZZ98506	M6	2,029	10	20
BZZ98508	M8	2,029	5	20
BZZ98510	M10	2,029	5	15
BZZ98512	M12	2,029	3	15



Caja con Ventana

CÓDIGO	MEDIDA	€/CAJA	PCS. 	CAJAS
VDZ98503	M3	4,428	100	8
VDZ98504	M4	4,428	100	8
VDZ98505	M5	4,623	100	8
VDZ98506	M6	5,332	80	8
VDZ98508	M8	5,291	50	8
VDZ98510	M10	5,905	25	8
VDZ98512	M12	5,914	15	8

INOXIDABLE



DIN-985 A2

Inoxidable A2



CÓDIGO	MEDIDA	€/100	LLAVE DE INSTALACIÓN		
D985IM04	M4	8,233	7	500	8.000
D985IM05	M5	8,867	8	500	8.000
D985IM06	M6	12,527	10	500	8.000
D985IM08	M8	24,697	13	250	4.000
D985IM10	M10	52,593	17	250	2.000
D985IM12	M12	81,753	19	100	1.200
D985IM14	M14	146,147	22	100	800
D985IM16	M16	177,133	24	50	600
D985IM18	M18	405,373	27	50	400
D985IM20	M20	519,897	30	25	300
D985IM22	M22	1.176,747	32	25	300
D985IM24	M24	1.586,600	36	25	150



Blister

CÓDIGO	MEDIDA	€/BOLSA	PCS. 	BOLSAS
BZ985IM04	M4	2,565	10	20
BZ985IM05	M5	2,565	8	20
BZ985IM06	M6	2,565	8	20
BZ985IM08	M8	2,565	6	20
BZ985IM10	M10	2,565	5	15



Caja con Ventana

CÓDIGO	MEDIDA	€/CAJA	PCS. 	CAJAS
VD985IM04	M4	5,454	50	8
VD985IM05	M5	5,877	50	8
VD985IM06	M6	8,302	50	8
VD985IM08	M8	9,819	30	8
VD985IM10	M10	13,942	20	8

DIN-6923

Tuerca brida grafilada

DIN-6923

METAL



Disponible en varios recubrimientos. Consulte precio y plazo de entrega.

CÓDIGO	MEDIDA	€/100	LLAVE DE INSTALACIÓN		
D692304	M4	3,153	7	500	15.000
D692305	M5	3,890	8	500	12.000
D692306	M6	5,887	10	500	8.000
D692308	M8	11,463	13	250	3.000
D692310	M10	18,713	15	250	2.000
D692312	M12	29,680	18	250	1.000
D692314	M14	51,900	21	100	600
D692316	M16	65,227	24	100	400

NEW DIN-6923 A2

Tuerca brida grafilada DIN-6923. Inoxidable A2

METAL



CÓDIGO	MEDIDA	€/100	LLAVE DE INSTALACIÓN		
D6923IM08	M8	22,833	13	250	3.000
D6923IM10	M10	38,510	15	250	3.000
D6923IM12	M12	65,500	18	250	1.500

DIN-1587

Tuerca ciega



Disponible en varios recubrimientos. Consulte precio y plazo de entrega.

METAL



CÓDIGO	MEDIDA	€/100	LLAVE DE INSTALACIÓN		
D158704	M4	8,120	7	500	15.000
D158705	M5	8,607	8	250	7.500
D158706	M6	10,083	10	250	4.000
D158708	M8	19,667	13	100	2.400
D158710	M10	37,933	17	100	1.600
D158712	M12	57,560	19	50	800
D158714	M14	98,393	22	50	600
D158716	M16	104,247	24	25	300



Blister

CÓDIGO	MEDIDA	€/BOLSA	PCS. 	BOLSAS
BZ158704	M4	2,029	20	20
BZ158705	M5	2,029	20	20
BZ158706	M6	2,029	10	20
BZ158708	M8	2,029	5	20
BZ158710	M10	2,029	5	20
BZ158712	M12	2,029	3	20



Caja con Ventana

CÓDIGO	MEDIDA	€/CAJA	PCS. 	CAJAS
VD158704	M4	7,480	75	8
VD158705	M5	5,289	50	8
VD158706	M6	6,193	50	8
VD158708	M8	6,042	25	8
VD158710	M10	9,320	20	8
VD158712	M12	7,073	10	8

METAL



CÓDIGO	MEDIDA	€/100		
D12503	M3	0,723	1.000	45.000
D12504	M4	0,913	1.000	45.000
D12505	M5	1,087	1.000	45.000
D12506	M6	1,933	500	22.500
D12508	M8	3,110	250	11.250
D12510	M10	5,360	250	6.000
D12512	M12	9,493	250	3.000
D12514	M14	13,057	200	2.400
D12516	M16	17,010	100	2.400
D12518	M18	21,453	100	2.400
D12520	M20	25,187	50	1.200
D12522	M22	42,983	50	1.200
D12524	M24	58,813	50	600
D12527	M27	80,000	50	600
D12530	M30	106,450	50	300
D12533	M33	172,223	50	300
D12536	M36	234,750	25	300

DIN-125

Cincada



Disponible en varios recubrimientos. Consulte precio y plazo de entrega.



Blister

CÓDIGO	MEDIDA	€/BOLSA	PCS.	BOLSAS
BZ125ZM03	M3	2,029	40	20
BZ125ZM04	M4	2,029	40	20
BZ125ZM05	M5	2,029	40	20
BZ125ZM06	M6	2,029	20	20
BZ125ZM08	M8	2,029	10	20
BZ125ZM10	M10	2,029	10	20
BZ125ZM12	M12	2,029	6	20



Caja con Ventana

CÓDIGO	MEDIDA	€/CAJA	PCS.	CAJAS
VD12503	M3	3,788	200	8
VD12504	M4	3,788	200	8
VD12505	M5	3,461	150	8
VD12506	M6	4,103	100	8
VD12508	M8	4,737	75	8
VD12510	M10	8,773	75	8
VD12512	M12	10,337	50	8

INOXIDABLE



CÓDIGO	MEDIDA	€/100		
D125IM04	M4	1,323	500	22.500
D125IM05	M5	1,750	500	22.500
D125IM06	M6	3,170	500	22.500
D125IM08	M8	5,437	250	11.250
D125IM10	M10	10,387	250	6.000
D125IM12	M12	18,477	250	3.000
D125IM14	M14	28,960	200	2.400
D125IM16	M16	31,977	100	2.400
D125IM18	M18	47,420	100	1.600
D125IM20	M20	50,357	50	1.200
D125IM22	M22	59,713	50	1.200
D125IM24	M24	104,480	50	600

DIN-125 A2

Inoxidable A2



Blister

CÓDIGO	MEDIDA	€/BOLSA	PCS.	BOLSAS
BZ125IM04	M4	2,565	10	20
BZ125IM05	M5	2,565	8	20
BZ125IM06	M6	2,565	8	20
BZ125IM08	M8	2,565	6	20
BZ125IM10	M10	2,565	5	20



Caja con Ventana

CÓDIGO	MEDIDA	€/CAJA	PCS.	CAJAS
VD125IM04	M4	3,241	100	8
VD125IM05	M5	3,252	75	8
VD125IM06	M6	4,108	75	8
VD125IM08	M8	4,283	50	8
VD125IM10	M10	7,142	50	8

DIN-9021

Arandela plana ancha

METAL



DIN-9021

Cincada



Disponible en varios recubrimientos. Consulte precio y plazo de entrega.

CÓDIGO	MEDIDA	€/100		
D902103	M3	1,557	500	22.500
D902104	M4	1,810	500	12.000
D902105	M5	1,980	500	12.000
D902106	M6	3,383	500	12.000
D902108	M8	7,927	200	4.800
D902110	M10	14,933	100	2.400
D902112	M12	27,097	100	1.200
D902114	M14	40,573	100	1.200
D902116	M16	46,700	50	600
D902118	M18	92,633	50	600
D902120	M20	97,863	25	300
D902122	M22	243,710	25	300
D902124	M24	264,517	25	150



Blister

CÓDIGO	MEDIDA	€/BOLSA	PCS.	BOLSAS
BZ902103	M3	2,029	20	20
BZ902104	M4	2,029	20	20
BZ902105	M5	2,029	20	20
BZ902106	M6	2,029	10	20
BZ902108	M8	2,029	5	20
BZ902110	M10	2,029	5	20
BZ902112	M12	2,029	4	20



Caja con Ventana

CÓDIGO	MEDIDA	€/CAJA	PCS.	CAJAS
VD902103	M3	3,646	125	8
VD902104	M4	3,646	125	8
VD902105	M5	4,036	125	8
VD902106	M6	4,723	100	8
VD902108	M8	5,313	50	8
VD902110	M10	5,860	30	8
VD902112	M12	5,292	15	8

DIN-9021 A2

Inoxidable A2



INOXIDABLE



CÓDIGO	MEDIDA	€/100		
D9021IM04	M4	2,380	500	22.500
D9021IM05	M5	4,357	500	12.000
D9021IM06	M6	7,893	500	8.000
D9021IM08	M8	15,560	200	4.800
D9021IM10	M10	35,207	100	1.600
D9021IM12	M12	60,720	100	800
D9021IM14	M14	131,004	100	800
D9021IM16	M16	132,610	50	600
D9021IM18	M18	237,443	50	400
D9021IM20	M20	266,213	25	300
D9021IM22	M22	274,243	25	200
D9021IM24	M24	315,377	25	150



Blister

CÓDIGO	MEDIDA	€/BOLSA	PCS.	BOLSAS
BZ9021IM04	M4	2,565	10	20
BZ9021IM05	M5	2,565	8	20
BZ9021IM06	M6	2,565	8	20
BZ9021IM08	M8	2,565	6	20
BZ9021IM10	M10	2,565	5	20



Caja con Ventana

CÓDIGO	MEDIDA	€/CAJA	PCS.	CAJAS
VD9021IM04	M4	3,508	100	8
VD9021IM05	M5	4,331	75	8
VD9021IM06	M6	7,846	75	8
VD9021IM08	M8	8,250	40	8
VD9021IM10	M10	9,333	20	8

METAL



CÓDIGO	MEDIDA	€/100		
D12703	M3	0,737	500	22.500
D12704	M4	0,913	500	22.500
D12705	M5	1,160	500	22.500
D12706	M6	1,433	500	12.000
D12708	M8	2,943	200	4.800
D12710	M10	4,597	100	2.400
D12712	M12	6,867	100	2.400
D12714	M14	10,597	100	2.400
D12716	M16	18,037	50	1.200
D12718	M18	19,027	50	1.200
D12720	M20	26,300	25	300
D12722	M22	30,200	25	600
D12724	M24	54,527	25	600
D12727	M27	79,700	25	600
D12730	M30	146,003	25	300
D12736	M36	296,237	25	300



Blister

CÓDIGO	MEDIDA	€/BOLSA	PCS. 	BOLSAS
BZ12703	M3	2,029	20	20
BZ12704	M4	2,029	20	20
BZ12705	M5	2,029	20	20
BZ12706	M6	2,029	10	20
BZ12708	M8	2,029	5	20
BZ12710	M10	2,029	5	20
BZ12712	M12	2,029	4	20



Caja con Ventana

CÓDIGO	MEDIDA	€/CAJA	PCS. 	CAJAS
VD12704	M4	3,018	100	8
VD12705	M5	3,297	100	8
VD12706	M6	4,172	100	8
VD12708	M8	3,700	50	8
VD12710	M10	3,375	25	8
VD12712	M12	4,433	25	8

DIN-127

Arandela muelle Grower



Disponible en varios recubrimientos. Consulte precio y plazo de entrega.

METAL



CÓDIGO	MEDIDA	€/100		
D127IM08	M8	4,530	200	9.000
D127IM10	M10	7,237	100	4.500
D127IM12	M12	10,923	100	4.500

DIN-127 A2 **NEW**

Arandela muelle grower DIN-127. Inoxidable A2



TU-MA

Tuerca mariposa

METAL



Disponible en varios recubrimientos. Consulte precio y plazo de entrega.



BLISTER y CAJA VENTANA
Sigüiente página

CÓDIGO	MEDIDA	€/100		
TUMAM03	M3	16,983	500	12.000
TUMAM04	M4	17,403	500	8.000
TUMAM05	M5	17,733	250	6.000
TUMAM06	M6	19,917	250	6.000
TUMAM08	M8	27,687	100	2.400
TUMAM10	M10	45,197	100	1.600
TUMAM12	M12	85,580	50	1.200
TUMAM14	M14	278,837	50	-
TUMAM16	M16	287,670	25	300



Blister

CÓDIGO	MEDIDA	€/BOLSA	PCS. 	BOLSAS
BZTUMAM03	M3	2,565	10	20
BZTUMAM04	M4	2,565	10	20
BZTUMAM05	M5	2,565	10	20
BZTUMAM06	M6	2,565	10	20
BZTUMAM08	M8	2,565	5	20
BZTUMAM10	M10	2,565	5	20
BZTUMAM12	M12	2,565	3	20



Caja con Ventana

CÓDIGO	MEDIDA	€/CAJA	PCS. 	CAJAS
VTUMAM03	M3	15,618	75	8
VTUMAM04	M4	16,004	75	8
VTUMAM05	M5	11,310	50	8
VTUMAM06	M6	12,210	50	8
VTUMAM08	M8	8,489	25	8
VTUMAM10	M10	11,525	20	8
VTUMAM12	M12	10,913	10	8

DIN-6798 A

Arandela dentada exterior

METAL



Disponible en varios recubrimientos. Consulte precio y plazo de entrega.

CÓDIGO	MEDIDA	€/100		
D6798A03	M3	1,280	500	22.500
D6798A04	M4	1,513	500	22.500
D6798A05	M5	1,650	500	22.500
D6798A06	M6	2,283	500	22.500
D6798A08	M8	4,447	250	11.250
D6798A10	M10	8,430	250	11.250
D6798A12	M12	9,787	100	4.500
D6798A14	M14	15,237	100	4.500
D6798A16	M16	18,873	100	4.500

BROCAS, PUNTAS Y ACCESORIOS



B-HDS

Broca SDS-Plus de alta calidad

MACIZOS



CÓDIGO	MEDIDA	€/PC	UD. MIN. VENTA		
BHDS06110	Ø6 x 110	21,231	2	1	50
BHDS06160	Ø6 x 160	21,725	2	1	100
BHDS06210	Ø6 x 210	23,286	2	1	150
BHDS08110	Ø8 x 110	21,725	2	1	50
BHDS08160	Ø8 x 160	22,705	2	1	100
BHDS08210	Ø8 x 210	23,776	2	1	150
BHDS10160	Ø10 x 160	24,301	2	1	100
BHDS10210	Ø10 x 210	27,615	2	1	150
BHDS12160	Ø12 x 160	27,164	2	1	100
BHDS12210	Ø12 x 210	29,740	2	1	150
BHDS16210	Ø16 x 210	45,938	2	1	150
BHDS16310	Ø16 x 260	47,705	2	1	200

PU

Puntas de atornillar

PU-PH

METAL

PH



CÓDIGO		€/100	LONGITUD		
PUPHC01	PH1	81,713	25	25	1.125
PUPHC02	PH2	81,713	25	25	1.125
PUPHC03	PH3	81,713	25	25	1.125
PUPHL01	PH1	131,080	50	25	1.125
PUPHL02	PH2	131,080	50	25	1.125
PUPHL03	PH3	131,080	50	25	1.125



Blister

CÓDIGO	MEDIDA	€/BOLSA	PCS. 	BOLSAS
BZPUPHCL01	N°1 / 50	3,427	4	20
BZPUPHCL02	N°2 / 50	3,427	4	20
BZPUPHCL03	N°3 / 50	3,427	4	20

PU-TO

METAL

TX





CÓDIGO		€/100	LONGITUD		
PUT0010	TX10	92,060	25	25	1.125
PUT0015	TX15	92,060	25	25	1.125
PUT0020	TX20	92,060	25	25	1.125
PUT0025	TX25	92,060	25	25	1.125
PUT0030	TX30	92,060	25	25	1.125
PUT0040	TX40	92,060	25	25	1.125



Blister

CÓDIGO	MEDIDA	€/BOLSA	PCS. 	BOLSAS
BZPUTOT01	T10+T20	3,427	2	20
BZPUTOT02	T30+T40	3,427	2	20

METAL

CÓDIGO		€/100	LONGITUD		
PUOXBITC10	OXB-10	115,077	25	25	1.125
PUOXBITC15	OXB-15	115,077	25	25	1.125
PUOXBITC20	OXB-20	115,077	25	25	1.125
PUOXBITC25	OXB-25	115,077	25	25	1.125
PUOXBITC30	OXB-30	115,077	25	25	1.125
PUOXBITC40	OXB-40	115,077	25	25	1.125
PUOXBITL10	OXB-10	197,073	50	25	1.125
PUOXBITL15	OXB-15	197,073	50	25	1.125
PUOXBITL20	OXB-20	197,073	50	25	1.125
PUOXBITL25	OXB-25	197,073	50	25	1.125
PUOXBITL30	OXB-30	197,073	50	25	1.125
PUOXBITL40	OXB-40	197,073	50	25	1.125



PU-OX

OXBIT



CARACTERÍSTICAS

Ajuste perfecto en tornillo:

Garantizan que el tornillo quede totalmente fijado en la punta, permitiendo una instalación ergonómica en cualquier posición y mejorando el guiado del tornillo.

Transmisión óptima de la fuerza:

Aseguran un asiento perfecto en la mortaja y aumentan la superficie de apriete, optimizando la transmisión del par de apriete.

Anti Cam-Out:

Las puntas OXBIT reducen el efecto "Cam-Out" que en el caso de trabajos con máquina son especialmente altas y pueden provocar un deslizamiento de la punta saliéndose de la mortaja del tornillo. Esto aumenta la vida útil de las puntas y de las mortajas.

Ideal para aplicaciones de altas prestaciones:

Especialmente diseñadas para garantizar la transmisión en trabajos con pares altos, soportan altas velocidades y el par de los atornilladores de impacto.

Menor esfuerzo:



Aumentan la transmisión del par de apriete, permitiendo la instalación con un menor esfuerzo, incluso con pares de apriete elevados.

Aumento de la vida útil de la punta:

Gracias al diseño de las puntas OXBIT y al ajuste perfecto con la mortaja, permiten alargar la vida útil de las puntas y de las mortajas.



METAL

CÓDIGO		€/100	LONGITUD		
PUPOC01	PZ1	81,713	25	25	1.125
PUPOC02	PZ2	81,713	25	25	1.125
PUPOC03	PZ3	81,713	25	25	1.125
PUPOL01	PZ1	131,080	50	25	1.125
PUPOL02	PZ2	131,080	50	25	1.125
PUPOL03	PZ3	131,080	50	25	1.125





PU-PO



PZ



Blister

CÓDIGO	MEDIDA	€/BOLSA	PCS. 	BOLSAS 
BZPUPOCL01	Nº 1 / 50	3,427	4	20
BZPUPOCL02	Nº 2 / 50	3,427	4	20
BZPUPOCL03	Nº 3 / 50	3,427	4	20

METAL

CÓDIGO		€/100	LONGITUD		
PUCUC01	PC1	81,713	25	25	1.125
PUCUC02	PC2	81,713	25	25	1.125
PUCUC03	PC3	81,713	25	25	1.125
PUCUL01	PC1	131,080	50	25	1.125
PUCUL02	PC2	131,080	50	25	1.125
PUCUL03	PC3	131,080	50	25	1.125

PU-CU

Cuadrada



BOCA

Bocas hexagonales magnéticas

METAL



CÓDIGO	MEDIDA	€/100	LLAVE DE INSTALACIÓN	LONGITUD		
BOCA006	6 mm.	603,317	1/4"	65	5	225
BOCA007	7 mm.	603,317	1/4"	65	5	225
BOCA008	8 mm.	603,317	1/4"	65	5	225
BOCA010	10 mm.	603,317	1/4"	65	5	225



Blister

CÓDIGO	MEDIDA	€/BOLSA	PCS.	BOLSAS
BZBOCA008	8 mm.	4,622	1	20
BZBOCA010	10 mm.	4,622	1	20

PU-PM

Porta puntas magnético 1/4

METAL



CÓDIGO	MEDIDA	€/100	LLAVE DE INSTALACIÓN	LONGITUD		
PUPM014	1/4" x 60	600,457	1/4"	65	5	225

ATAP

Tapón de nylon de colores para tornillos con cabeza hexagonal

METAL



CÓDIGO		COLOR	€/100		
ATAPO08AR	8	RAL 1.001	7,197	1.000	2.000
ATAPO08RC	8	RAL 3.003	7,197	1.000	2.000
ATAPO08RT	8	RAL 3.011	7,197	1.000	2.000
ATAPO08VN	8	RAL 6.028	7,197	1.000	2.000
ATAPO08BP	8	RAL 9.010	7,197	1.000	2.000
ATAPO08NE	8	RAL 9.005	7,197	1.000	2.000
ATAPO08BO	8	RAL 9.002	7,197	1.000	2.000
ATAPO10AR	10	RAL 1.001	7,197	1.000	2.000
ATAPO10RC	10	RAL 3.003	7,197	1.000	2.000
ATAPO10RT	10	RAL 3.011	7,197	1.000	2.000
ATAPO10VN	10	RAL 6.028	7,197	1.000	2.000
ATAPO10BP	10	RAL 9.010	7,197	1.000	2.000
ATAPO10NE	10	RAL 9.005	7,197	1.000	2.000
ATAPO10BO	10	RAL 9.002	7,197	1.000	2.000



Tapones de PVC para tornillos DIN-7504-N y DIN-7981

TP-CR



CÓDIGO	MEDIDA	€/100		
TPCR042BL	Ø4,2	3,757	1.000	12.000
TPCR048BL	Ø4,8	3,757	1.000	12.000
TPCR055BL	Ø5,5	3,757	1.000	6.000

TP-CR B

Blanco



CÓDIGO	MEDIDA	€/100		
TPCR042NE	Ø4,2	3,757	1.000	12.000
TPCR048NE	Ø4,8	3,757	1.000	12.000
TPCR055NE	Ø5,5	3,757	1.000	6.000

TP-CR N

Negro



Tapones adhesivos de colores tapa-tornillo

TP-TP



CÓDIGO	COLOR	DIÁMETRO	€/100		
TPTPADBE	BEIGE	14	3,710	1.000	24.000
TPTPADBL	BLANCO	14	3,710	1.000	24.000
TPTPADCA	CAOBA	14	3,710	1.000	24.000
TPTPADCE	CEREZO	14	3,710	1.000	24.000
TPTPADGR	GRIS	14	3,710	1.000	24.000
TPTPADHA	HAYA	14	3,710	1.000	24.000
TPTPADNE	NEGRO	14	3,710	1.000	24.000
TPTPADNO	NOGAL	14	3,710	1.000	24.000
TPTPADPI	PINO	14	3,710	1.000	24.000
TPTPADRO	ROBLE	14	3,710	1.000	24.000
TPTPADSA	SAPELLY	14	3,710	1.000	24.000



Blister

CÓDIGO	COLOR	€/BOLSA	PCS.	BOLSAS
BZTPTPADBE	BEIGE	2,029	20	25
BZTPTPADBL	BLANCO	2,029	20	25
BZTPTPADCA	CAOBA	2,029	20	25
BZTPTPADCE	CEREZO	2,029	20	25
BZTPTPADGR	GRIS	2,029	20	25
BZTPTPADHA	HAYA	2,029	20	25
BZTPTPADNE	NEGRO	2,029	20	25
BZTPTPADNO	NOGAL	2,029	20	25
BZTPTPADPI	PINO	2,029	20	25
BZTPTPADRO	ROBLE	2,029	20	25
BZTPTPADSA	SAPELLY	2,029	20	25

Tiras de **venta cruzada**

Productos "gancho" para lugares específicos. La venta cruzada permite aumentar las ventas de **productos afines o complementarios**, situándolos juntos en el punto de venta.

Los tapones de colores son un buen ejemplo de este tipo de venta. Se trata de un producto complementario a todo tipo de tornillo para madera.

VENTAJAS:

- Favorece el **autoservicio** en la sala de ventas.
- Incrementa la **compra** por impulso y **potencia la venta cruzada** de productos.
- Crea **valor** para el consumidor final.



































¿Cómo conseguirlo? Junto con tu pedido de tapones en formato blister pide a tu comercial INDEX una tira de venta cruzada (Código: TIRAEASY).

























ABRAZADERAS METÁLICAS PESADAS



	MEDIDAS (mm)	CARGA RECOMENDADA kg	RECUBRIMIENTO	ESPESOR (mm)	ANCHURA (mm)	APERTURA	MANGUITO	HOMOLOGACIÓN	ISOFÓNICA	CTE
AB-RA	APLICACIONES: Saneamiento Eléctrico									P. 234
	Ø 15 - Ø 125	80		1,5	20	Rápida lateral	M8	-	-	-
AB-IA	APLICACIONES: ACS y AF, Gas, Saneamiento, Calefacción, Climatización, Eléctrico, Ventilación									P. 235
	Ø 15 - Ø 125	80		1,5	20	Rápida lateral	M8	-		
AB-IR	APLICACIONES: ACS y AF, Gas, Saneamiento, Calefacción, Climatización, Eléctrico, Ventilación									P. 235
	Ø 15 - Ø 60	60		1,25	19	Rápida vertical	M8	-		
AB-RE AB-RE V	APLICACIONES: Saneamiento, Eléctrico, Ventilación									P. 236
	Ø 18 - Ø 1250	150 - 200		1,8 - 2,3	19	Tornillo	M8 / M10	-	-	-
AB-RI AB-RI V	APLICACIONES: ACS y AF, Gas, Saneamiento, Calefacción, Climatización, Eléctrico, Ventilación									P. 238
	Ø 18 - Ø 1250	150 - 200		1,8 - 2,3	19	Tornillo	M8 / M10	-		
AB-RE A2 AB-RE A4	APLICACIONES: ACS y AF, Gas, Saneamiento, Calefacción, Climatización, Eléctrico, Ventilación									P. 237
	Ø 18 - Ø 1250	150 - 200	 A2 INOX AISI 304  A4 INOX AISI 316 AB-RE A2 AB-RE A4	1,8 - 2,3	19	Tornillo	M8 / M10	-		
AB-RI A2 AB-RI A4	APLICACIONES: ACS y AF, Gas, Saneamiento, Calefacción, Climatización, Eléctrico, Ventilación									P. 239
	Ø 18 - Ø 1250	150 - 200	 A2 INOX AISI 304  A4 INOX AISI 316 AB-RI A2 AB-RI A4	1,8 - 2,3	19	Tornillo	M8 / M10	-		
AB-RI DES	APLICACIONES: Saneamiento, Eléctrico									P. 240
	Ø 16 - Ø 160	150		1,2 - 2,0	20	Rápida lateral	M8 / M10	-		
AB-ICP	APLICACIONES: ACS y AF, Gas, Saneamiento, Calefacción, Climatización, Eléctrico, Ventilación									P. 240
	Ø 60 - Ø 135	200		2,75 - 4,0	30 - 40	Tornillo	M8 / M10 M10 / M12 M12 / M16	-		

	MEDIDAS (mm)	CARGA RECOMENDADA kg	RECUBRIMIENTO	ESPESOR (mm)	ANCHURA (mm)	APERTURA	MANGUITO	HOMOLOGACIÓN	ISOFÓNICA	CTE
AB-AIS	APLICACIONES: ACS y AF, Gas, Saneamiento, Calefacción, Climatización, Eléctrico, Ventilación									P. 241
	Ø 10 - Ø 219	150 - 200		13 - 40	20 - 40	AB-AIS 13 & 19 Rápida lateral AB-AIS 30 & 40 Tornillo	M8 / M10 M8 / M10 M12 / M16	-	 	
AB-GA	APLICACIONES: Gas									P. 242
	Ø 18 - Ø 160	150 - 200		2	19	Tornillo	M8 ≤ Ø54 M8 / M10 > Ø54	De acuerdo a UNE-EN ISO 4892	-	-
AB-M8	APLICACIONES: Saneamiento, Desagüe									P. 242
	Ø 50 - Ø 315	100		1	28	Tornillo	M8	-	-	-
AB-DE Z AB-DE G	APLICACIONES: Saneamiento, Desagüe									P. 243
	Ø 75 - Ø 315	200	 	2,5	20	Tornillo	M8	-	-	-
			AB-DE Z AB-DE G							
AB-DP Z AB-DP G	APLICACIONES: Saneamiento, Desagüe									P. 243
	Ø 75 - Ø 250	200	 	2,5	20	Tornillo	-	-	-	-
			AB-DP Z AB-DP G							
AB-ZI	APLICACIONES: Gas, Saneamiento									P. 244
	Ø 16 - Ø 230	250 - 350		M6 - M8 - M10	-	-	-	-	-	-
AB-SA	APLICACIONES: Gas, Saneamiento									P. 245
	-	-		5 - 6	-	-	-	-	-	-
AB-GP	APLICACIONES: Saneamiento, Industrial									P. 245
	Ø 25 - Ø 235	-		0,6 - 1,8	18 - 25	Tornillo	-	-	-	-

AB-RA

Abrazadera reforzada M8 abierta



02
P. 390
Info.
Técnica

ABERTURA LATERAL

INSTALACIÓN



EXPRESS

CÓDIGO	MEDIDA	€/100	MEDIDA EN PULGADAS	ØD(MM)	CARGA MÁXIMA		
ABRA015	15 (M8)	84,257	1/4"	12-16	80	50	300
ABRA018	18 (M8)	84,610	3/8"	15 - 19	80	50	300
ABRA022	22 (M8)	90,480	1/2"	20 - 25	80	50	200
ABRA028	28 (M8)	94,257	3/4"	26 - 30	80	50	200
ABRA035	35 (M8)	100,307	1"	32 - 36	80	50	150
ABRA042	42 (M8)	105,600	1 1/4"	38 - 43	80	50	150
ABRA048	48 (M8)	115,680	1 1/2"	47 - 51	80	50	100
ABRA054	54 (M8)	121,557	-	53 - 58	80	25	100
ABRA060	60 (M8)	127,263	2"	60 - 64	80	25	75
ABRA075	75 (M8)	142,693	2 1/2"	75 - 80	80	25	50
ABRA090	90 (M8)	151,773	3"	87 - 92	80	25	50
ABRA100	100 (M8)	170,450	3 1/2"	99 - 105	80	25	50
ABRA110	110 (M8)	171,220	-	107 - 112	80	25	50
ABRA115	115 (M8)	197,070	4"	113 - 118	80	25	50
ABRA125	125 (M8)	196,783	4 1/2"	125 - 130	80	25	50

EJEMPLOS DE APLICACIÓN





Abrazadera reforzada isofónica M8 abierta

AB-IA



CÓDIGO	MEDIDA	€/100	MEDIDA EN PULGADAS	ØD(MM)	CARGA MÁXIMA		
ABIA015	15 (M8)	93,520	1/4"	12-16	80	50	200
ABIA018	18 (M8)	99,010	3/8"	15 - 19	80	50	200
ABIA022	22 (M8)	105,090	1/2"	20 - 25	80	50	150
ABIA028	28 (M8)	109,683	3/4"	26 - 30	80	50	100
ABIA035	35 (M8)	117,257	1"	32 - 36	80	50	100
ABIA042	42 (M8)	130,363	1 1/4"	38 - 43	80	50	-
ABIA048	48 (M8)	148,570	1 1/2"	47 - 51	80	50	-
ABIA054	54 (M8)	155,127	-	53 - 58	80	25	50
ABIA060	60 (M8)	168,160	2"	60 - 64	80	25	50
ABIA075	75 (M8)	188,100	2 1/2"	75 - 80	80	25	50
ABIA090	90 (M8)	208,983	3"	87 - 92	80	25	50
ABIA100	100 (M8)	231,280	3 1/2"	99 - 105	80	25	50
ABIA110	110 (M8)	238,590	-	107 - 112	80	25	-
ABIA115	115 (M8)	275,763	4"	113 - 118	80	25	-
ABIA125	125 (M8)	295,083	4 1/2"	125 - 130	80	25	-



02
P. 330

Info
Técnica

ABERTURA LATERAL



INSTALACIÓN

EXPRESS

CTE

CÓDIGO TÉCNICO
DE LA EDIFICACIÓN

EJEMPLOS DE APLICACIÓN



Abrazadera isofónica M8 instalación rápida

AB-IR



CÓDIGO	MEDIDA	€/100	MEDIDA EN PULGADAS	ØD(MM)	CARGA MÁXIMA		
ABIR015	15 (M8)	85,663	1/4"	14 - 15	60	50	300
ABIR018	18 (M8)	91,600	3/8"	16 - 19	60	50	300
ABIR022	22 (M8)	95,560	1/2"	21 - 23	60	50	200
ABIR028	28 (M8)	105,510	3/4"	26 - 28	60	50	150
ABIR035	35 (M8)	115,610	1"	32 - 35	60	50	100
ABIR040	40 (M8)	130,427	1 1/4"	40 - 43	60	25	100
ABIR048	48 (M8)	142,977	1 1/2"	48 - 51	60	25	100
ABIR054	54 (M8)	150,640	-	52 - 56	60	25	75
ABIR060	60 (M8)	158,170	2"	57 - 60	60	25	75



02
P. 330

Info
Técnica

ABERTURA VERTICAL



INSTALACIÓN

EXPRESS

CTE

CÓDIGO TÉCNICO
DE LA EDIFICACIÓN

EJEMPLOS DE APLICACIÓN



AB-RE

Abrazadera reforzada M8 + M10

AB-RE

Cincada



02 Info
Técnica
P. 331

REFORZADA M8 + M10



EJEMPLOS DE APLICACIÓN



CÓDIGO	MEDIDA	€/100	MEDIDA EN PULGADAS	ØD(MM)	CARGA MÁXIMA		
ABRE018	18 (M8+M10)	115,440	3/8"	15 - 19	150	50	300
ABRE022	22 (M8+M10)	118,903	1/2"	20 - 25	150	50	200
ABRE028	28 (M8+M10)	132,020	3/4"	26 - 30	150	50	150
ABRE035	35 (M8+M10)	141,703	1"	32 - 36	150	50	100
ABRE040	40 (M8+M10)	148,750	1 1/4"	38 - 43	150	25	100
ABRE048	48 (M8+M10)	159,057	1 1/2"	47 - 51	150	25	100
ABRE054	54 (M8+M10)	169,667	-	53 - 56	150	25	75
ABRE060	60 (M8+M10)	179,513	2"	60 - 64	150	25	75
ABRE070	70 (M8+M10)	187,647	-	68 - 72	150	25	50
ABRE075	75 (M8+M10)	192,560	2 1/2"	75 - 80	150	25	50
ABRE083	83 (M8+M10)	200,873	-	81 - 86	150	25	-
ABRE090	90 (M8+M10)	216,163	3"	87 - 92	150	25	-
ABRE100	100 (M8+M10)	222,550	3 1/2"	99 - 105	150	25	-
ABRE110	110 (M8+M10)	241,380	-	107 - 112	200	25	-
ABRE115	115 (M8+M10)	271,863	4"	113 - 118	200	25	-
ABRE125	125 (M8+M10)	290,640	4 1/2"	125 - 130	200	25	-
ABRE133	133 (M8+M10)	318,340	-	132 - 137	200	25	-
ABRE140	140 (M8+M10)	360,323	5"	138 - 142	200	25	-
ABRE150	150 (M8+M10)	366,327	-	148 - 152	200	25	-
ABRE160	160 (M8+M10)	384,347	6"	159 - 166	200	25	-
ABRE180	180 (M8+M10)	407,917	-	179 - 184	200	25	-
ABRE200	200 (M8+M10)	443,650	-	199 - 212	200	25	-
ABRE220	220 (M8+M10)	505,723	8"	215 - 226	200	25	-
ABRE250	250 (M8+M10)	560,390	-	245 - 254	200	25	-
ABRE280	280 (M8+M10)	640,220	-	278 - 284	200	25	-
ABRE300	300 (M8+M10)	720,050	-	299 - 304	200	25	-
ABRE315	315 (M8+M10)	809,773	-	314 - 319	200	25	-
ABRE355	355 (M8+M10)	1.026,160	-	354 - 359	200	25	-

Bolsa Autoservicio

CÓDIGO	MEDIDA	€/BOLSA	PCS.	BOLSAS
LSABRETO22	22	5,087	2	5
LSABRETO28	28	5,210	2	5
LSABRETO35	35	5,325	2	5
LSABRETO40	40	5,468	2	5
LSABRETO48	48	5,360	2	5
LSABRETO60	60	5,611	2	5
LSABRETO75	75	5,888	2	5
LSABRETO90	90	7,226	2	5
LSABRET110	110	7,496	2	5
LSABRET125	125	8,665	2	4

KIT
AB-RE + ES-DR
+ T4S



AB-RE V

Abrazadera Reforzada M8+M10 Ventilación



02 Info
Técnica
P. 377

REFORZADA M8 + M10



CÓDIGO	MEDIDA	€/100	MEDIDA EN PULGADAS	ØD(MM)	CARGA MÁXIMA		
ABRE250	250 (M8+M10)	560,390	-	245 - 254	200	25	-
ABRE280	280 (M8+M10)	640,220	-	278 - 284	200	25	-
ABRE300	300 (M8+M10)	720,050	-	299 - 304	200	25	-
ABRE315	315 (M8+M10)	809,773	-	314 - 319	200	25	-
ABRE355	355 (M8+M10)	1.026,160	-	354 - 359	200	25	-
ABRE400	400 (M8+M10)	1.212,443	-	399 - 404	200	25	-
ABRE450	450 (M8+M10)	1.478,517	-	449 - 454	200	10	-
ABRE500	500 (M8+M10)	1.455,087	-	499 - 504	200	10	-
ABRE560	560 (M8+M10)	1.740,553	-	555 - 561	200	10	-
ABRE600	600 (M8+M10)	1.852,463	-	599 - 604	200	10	-
ABRE630	630 (M8+M10)	1.981,940	-	625 - 631	200	10	-
ABRE710	710 (M8+M10)	2.234,333	-	705 - 711	200	10	-
ABRE800	800 (M8+M10)	2.471,980	-	799 - 804	200	10	-
ABRE900	900 (M8+M10)	2.740,407	-	899 - 904	200	10	-
ABRE910	1000 (M8+M10)	3.070,133	-	999 - 1.004	200	10	-
ABRE911	1120 (M8+M10)	3.361,427	-	1.115 - 1.121	200	10	-
ABRE912	1250 (M8+M10)	3.691,750	-	1.245 - 1.251	200	10	-

Abrazadera reforzada M8 + M10

AB-RE

INOXIDABLE



CÓDIGO	MEDIDA	€/100	MEDIDA EN PULGADAS	ØD(MM)	CARGA MÁXIMA		
ABREA2018	18 (M8+M10)	350,963	3/8"	15 - 18	150	50	300
ABREA2022	22 (M8+M10)	369,093	1/2"	20 - 24	150	50	200
ABREA2028	28 (M8+M10)	405,210	3/4"	26 - 30	150	50	150
ABREA2035	35 (M8+M10)	423,987	1"	32 - 36	150	50	100
ABREA2040	40 (M8+M10)	448,793	1 1/4"	36 - 42	150	25	100
ABREA2048	48 (M8+M10)	473,157	1 1/2"	47 - 50	150	25	100
ABREA2054	54 (M8+M10)	499,703	-	51 - 55	150	25	75
ABREA2060	60 (M8+M10)	531,453	2"	60 - 64	150	25	75
ABREA2075	75 (M8+M10)	601,983	2 1/2"	75 - 80	150	25	50
ABREA2090	90 (M8+M10)	692,637	3"	87 - 92	150	25	-
ABREA2110	110 (M8+M10)	749,337	-	106 - 112	150	25	-
ABREA2115	115 (M8+M10)	781,637	4"	114 - 119	150	25	-
ABREA2125	125 (M8+M10)	838,380	4 1/2"	124 - 131	150	25	-
ABREA2140	140 (M8+M10)	926,653	5"	133 - 140	150	25	-
ABREA2160	160 (M8+M10)	1.057,567	6"	159 - 163	150	25	-
ABREA2200	200 (M8+M10)	1.475,183	-	199 - 212	150	25	-

AB-RE A2

Inoxidable A2



REFORZADA

M8 + M10



INOXIDABLE



CÓDIGO	MEDIDA	€/100	MEDIDA EN PULGADAS	ØD(MM)	CARGA MÁXIMA		
ABREA4018	18 (M8+M10)	449,050	3/8"	15 - 18	150	50	300
ABREA4022	22 (M8+M10)	474,767	1/2"	20 - 24	150	50	200
ABREA4028	28 (M8+M10)	507,057	3/4"	26 - 30	150	50	150
ABREA4035	35 (M8+M10)	529,697	1"	32 - 36	150	50	100
ABREA4040	40 (M8+M10)	568,197	1 1/4"	36 - 42	150	25	100
ABREA4048	48 (M8+M10)	613,867	1 1/2"	47 - 50	150	25	100
ABREA4054	54 (M8+M10)	640,433	-	51 - 55	150	25	75
ABREA4060	60 (M8+M10)	682,693	2"	60 - 64	150	25	75
ABREA4075	75 (M8+M10)	757,447	2 1/2"	75 - 80	150	25	50
ABREA4090	90 (M8+M10)	830,587	3"	87 - 92	150	25	-
ABREA4110	110 (M8+M10)	956,430	-	106 - 112	150	25	-
ABREA4115	115 (M8+M10)	1.026,100	4"	114 - 119	150	25	-
ABREA4125	125 (M8+M10)	1.081,013	4 1/2"	124 - 131	150	25	-
ABREA4140	140 (M8+M10)	1.279,617	5"	133 - 140	150	25	-
ABREA4160	160 (M8+M10)	1.404,623	-	159 - 163	150	25	-
ABREA4200	200 (M8+M10)	1.704,457	-	199 - 212	150	25	-

AB-RE A4

Inoxidable A4



REFORZADA

M8 + M10



EJEMPLOS DE APLICACIÓN



AB-RI

Abrazadera isofónica reforzada M8 + M10

AB-RI

Cincada



02 Info Técnica p. 391



M8 + M10



EJEMPLOS DE APLICACIÓN



CÓDIGO	MEDIDA	€/100	MEDIDA EN PULGADAS	ØD(MM)	CARGA MÁXIMA		
ABRI018	18 (M8+M10)	136,453	3/8"	15 - 19	150	50	200
ABRI022	22 (M8+M10)	145,253	1/2"	20 - 25	150	50	150
ABRI028	28 (M8+M10)	156,517	3/4"	26 - 30	150	50	150
ABRI035	35 (M8+M10)	165,517	1"	32 - 36	150	50	100
ABRI040	40 (M8+M10)	188,043	1 1/4"	38 - 43	150	25	75
ABRI048	48 (M8+M10)	202,687	1 1/2"	47 - 51	150	25	75
ABRI054	54 (M8+M10)	213,950	-	53 - 56	150	25	50
ABRI060	60 (M8+M10)	236,467	2"	60 - 64	150	25	50
ABRI070	70 (M8+M10)	244,910	-	68 - 72	150	25	-
ABRI075	75 (M8+M10)	272,440	2 1/2"	75 - 80	150	25	-
ABRI083	83 (M8+M10)	275,870	-	81 - 86	150	25	-
ABRI090	90 (M8+M10)	303,577	3"	87 - 92	150	25	-
ABRI100	100 (M8+M10)	315,287	3 1/2"	99 - 105	150	25	-
ABRI110	110 (M8+M10)	365,957	-	107 - 112	200	25	-
ABRI115	115 (M8+M10)	388,473	4"	113 - 118	200	25	-
ABRI125	125 (M8+M10)	425,077	4 1/2"	125 - 130	200	25	-
ABRI133	133 (M8+M10)	430,713	-	132 - 137	200	25	-
ABRI140	140 (M8+M10)	484,200	5"	138 - 142	200	25	-
ABRI150	150 (M8+M10)	494,897	-	148 - 152	200	25	-
ABRI160	160 (M8+M10)	534,857	6"	159 - 166	200	25	-
ABRI180	180 (M8+M10)	548,987	-	179 - 184	200	25	-
ABRI200	200 (M8+M10)	608,057	-	199 - 212	200	25	-
ABRI220	220 (M8+M10)	698,140	8"	215 - 226	200	25	-
ABRI250	250 (M8+M10)	784,863	-	245 - 254	200	25	-
ABRI280	280 (M8+M10)	839,010	-	278 - 284	200	25	-
ABRI300	300 (M8+M10)	893,153	-	299 - 304	200	25	-
ABRI315	315 (M8+M10)	994,400	-	314 - 319	200	25	-
ABRI355	355 (M8+M10)	1.398,647	-	354 - 359	200	25	-

Bolsa Autoservicio

CÓDIGO	MEDIDA	€/BOLSA	PCS.	BOLSAS
LSABRIT022	22	5,553	2	5
LSABRIT028	28	5,711	2	5
LSABRIT035	35	5,904	2	5
LSABRIT040	40	5,904	2	5
LSABRIT048	48	6,120	2	5
LSABRIT060	60	6,544	2	5
LSABRIT075	75	7,057	2	5
LSABRIT090	90	8,110	2	5
LSABRIT110	110	9,502	2	4

KIT AB-RI + ES-DR + T4S



AB-RI V

Abrazadera Reforzada Isofónica M8+M10 Ventilación



02 Info Técnica p. 377



M8 + M10



CÓDIGO	MEDIDA	€/100	MEDIDA EN PULGADAS	ØD(MM)	CARGA MÁXIMA		
ABRI250	250 (M8+M10)	784,863	-	245 - 254	200	25	-
ABRI280	280 (M8+M10)	839,010	-	278 - 284	200	25	-
ABRI300	300 (M8+M10)	893,153	-	299 - 304	200	25	-
ABRI315	315 (M8+M10)	994,400	-	314 - 319	200	25	-
ABRI355	355 (M8+M10)	1.398,647	-	354 - 359	200	25	-
ABRI400	400 (M8+M10)	1.518,070	-	399 - 404	200	25	-
ABRI450	450 (M8+M10)	1.828,133	-	449 - 454	200	10	-
ABRI500	500 (M8+M10)	1.876,140	-	499 - 504	200	10	-
ABRI560	560 (M8+M10)	2.082,227	-	555 - 561	200	10	-
ABRI600	600 (M8+M10)	2.296,567	-	599 - 604	200	10	-
ABRI630	630 (M8+M10)	2.493,600	-	625 - 631	200	10	-
ABRI710	710 (M8+M10)	2.889,580	-	705 - 711	200	10	-
ABRI800	800 (M8+M10)	3.139,883	-	799 - 804	200	10	-
ABRI900	900 (M8+M10)	3.564,213	-	899 - 904	200	10	-
ABRI910	1000 (M8+M10)	4.062,897	-	999 - 1.004	200	10	-
ABRI911	1120 (M8+M10)	4.488,487	-	1.115 - 1.121	200	10	-
ABRI912	1250 (M8+M10)	4.912,803	-	1.245 - 1.251	200	10	-

Abrazadera isofónica reforzada M8 + M10

AB-RI

INOXIDABLE



CÓDIGO	MEDIDA	€/100	MEDIDA EN PULGADAS	ØD(MM)	CARGA MÁXIMA		
ABRIA2018	18 (M8+M10)	452,633	3/8"	15 - 18	150	50	200
ABRIA2022	22 (M8+M10)	465,123	1/2"	20 - 24	150	50	150
ABRIA2028	28 (M8+M10)	485,820	3/4"	26 - 30	150	50	150
ABRIA2035	35 (M8+M10)	511,127	1"	32 - 36	150	50	100
ABRIA2040	40 (M8+M10)	538,987	1 1/4"	36 - 42	150	25	75
ABRIA2048	48 (M8+M10)	571,240	1 1/2"	47 - 50	150	25	75
ABRIA2054	54 (M8+M10)	623,673	-	51 - 55	150	25	50
ABRIA2060	60 (M8+M10)	657,530	2"	60 - 64	150	25	50
ABRIA2075	75 (M8+M10)	740,760	2 1/2"	75 - 80	150	25	-
ABRIA2090	90 (M8+M10)	800,907	3"	87 - 92	150	25	-
ABRIA2110	110 (M8+M10)	890,610	-	106 - 112	150	25	-
ABRIA2115	115 (M8+M10)	915,293	4"	114 - 119	150	25	-
ABRIA2125	125 (M8+M10)	986,493	4 1/2"	124 - 131	150	25	-
ABRIA2140	140 (M8+M10)	1.021,377	5"	133 - 140	150	25	-
ABRIA2160	160 (M8+M10)	1.145,937	6"	159 - 163	150	25	-

AB-RI A2

Inoxidable A2



02 Info. Técnica P. 392

CTE
CÓDIGO TÉCNICO DE LA EDIFICACIÓN

REFORZADA
R

M8 + M10



INOXIDABLE



CÓDIGO	MEDIDA	€/100	MEDIDA EN PULGADAS	ØD(MM)	CARGA MÁXIMA		
ABRIA4018	18 (M8+M10)	536,790	3/8"	15 - 18	150	50	200
ABRIA4022	22 (M8+M10)	564,327	1/2"	20 - 24	150	50	150
ABRIA4028	28 (M8+M10)	589,053	3/4"	26 - 30	150	50	150
ABRIA4035	35 (M8+M10)	633,163	1"	32 - 36	150	50	100
ABRIA4040	40 (M8+M10)	682,457	1 1/4"	36 - 42	150	25	75
ABRIA4048	48 (M8+M10)	733,720	1 1/2"	47 - 50	150	25	75
ABRIA4054	54 (M8+M10)	770,017	-	51 - 55	150	25	50
ABRIA4060	60 (M8+M10)	841,693	2"	60 - 64	150	25	50
ABRIA4075	75 (M8+M10)	920,903	2 1/2"	75 - 80	150	25	-
ABRIA4090	90 (M8+M10)	1.010,433	3"	87 - 92	150	25	-
ABRIA4110	110 (M8+M10)	1.191,347	-	106 - 112	150	25	-
ABRIA4115	115 (M8+M10)	1.238,547	4"	114 - 119	150	25	-
ABRIA4125	125 (M8+M10)	1.312,093	4 1/2"	124 - 131	150	25	-
ABRIA4140	140 (M8+M10)	1.422,880	5"	133 - 140	150	25	-
ABRIA4160	160 (M8+M10)	1.630,030	6"	159 - 163	150	25	-

AB-RI A4

Inoxidable A4



02 Info. Técnica P. 392

CTE
CÓDIGO TÉCNICO DE LA EDIFICACIÓN

REFORZADA
R

M8 + M10



EJEMPLOS DE APLICACIÓN



AB-RI DES

Abrazadera isofónica reforzada deslizante M8+M10



CÓDIGO	MEDIDA	€/100	📦	
ABRID016	16	196,230	150	
ABRID020	20	204,403	100	
ABRID025	25	216,667	100	
ABRID032	32	237,110	100	
ABRID040	40	257,547	50	
ABRID050	50	329,090	50	
ABRID063	63	412,893	50	
ABRID075	75	470,127	50	
ABRID090	90	519,183	50	
ABRID110	110	674,533	25	
ABRID125	125	817,613	25	
ABRID140	140	866,670	20	
ABRID160	160	1.001,577	20	

PA-EX

Patín de expansión



CÓDIGO	MEDIDA	€/100	📦	
PAEXM08	M8 x 180	3.408,673	50	-
PAEXM10	M10 x 180	3.408,673	50	-

CO-AR

Colgador articulado



CÓDIGO	MEDIDA	€/100	📦	
COAR08060	M8 x 60	234,460	50	300
COAR10060	M10 x 60	360,707	50	300

AB-ICP

Abrazadera isofónica reforzada para cargas pesadas



CÓDIGO	MEDIDA	€/100	Ø(MM)	📦
ABICP060	60 (M8+M10)	867,593	60 - 64	25
ABICP075	75 (M10+M12)	1.060,390	75 - 80	25
ABICP090	90 (M10+M12)	1.156,787	87 - 92	25
ABICP110	110 (M10+M12)	1.325,487	107 - 112	25
ABICP140	140 (M12+M16)	2.313,580	138 - 142	25
ABICP160	160 (M12+M16)	2.747,373	159 - 166	25
ABICP220	220 (M12+M16)	3.614,967	215 - 226	10
ABICP270	270 (M12+M16)	4.529,250	268 - 274	10
ABICP315	315 (M12+M16)	5.136,263	314 - 319	10

Abrazadera aislante térmica

AB-AIS



CÓDIGO	MEDIDA	€/100	ESPEJOR AISLANTE(MM)	
ABAIS13010	Ø10	797,173	13	50
ABAIS13012	Ø12	817,613	13	50
ABAIS13015	Ø15	838,053	13	50
ABAIS13018	Ø18	899,377	13	50
ABAIS13022	Ø22	960,697	13	50
ABAIS13028	Ø28	1.001,577	13	50

AB-AIS 13

13 mm



CÓDIGO	MEDIDA	€/100	ESPEJOR AISLANTE(MM)	
ABAIS19010	Ø10	981,137	19	50
ABAIS19012	Ø12	1.001,577	19	50
ABAIS19015	Ø15	1.062,900	19	50
ABAIS19017	Ø17	1.062,900	19	50
ABAIS19018	Ø18	1.083,337	19	50
ABAIS19022	Ø22	1.103,777	19	50
ABAIS19028	Ø28	1.185,540	19	50
ABAIS19035	Ø35	1.267,300	19	50
ABAIS19042	Ø42	1.369,503	19	25
ABAIS19054	Ø54	1.553,470	19	25
ABAIS19060	Ø60	1.716,990	19	25
ABAIS19064	Ø64	1.880,513	19	25
ABAIS19067	Ø67	2.003,157	19	25
ABAIS19076	Ø76	2.146,237	19	25
ABAIS19080	Ø80	2.248,437	19	25
ABAIS19114	Ø114	3.066,050	19	10

AB-AIS 19

19 mm



CÓDIGO	MEDIDA	€/100	ESPEJOR AISLANTE(MM)	
ABAIS30027	Ø27	1.492,147	30	50
ABAIS30034	Ø34	1.614,787	30	50
ABAIS30042	Ø42	1.716,990	30	25
ABAIS30049	Ø49	1.778,310	30	25
ABAIS30054	Ø54	2.146,237	30	25
ABAIS30060	Ø60	2.187,120	30	25
ABAIS30076	Ø76	2.289,320	30	25
ABAIS30089	Ø89	2.432,400	30	25
ABAIS30108	Ø108	3.372,657	30	10
ABAIS30114	Ø114	3.474,860	30	10

AB-AIS 30

30 mm



CÓDIGO	MEDIDA	€/100	ESPEJOR AISLANTE(MM)	
ABAIS40049	Ø49	2.227,997	40	25
ABAIS40060	Ø60	2.616,363	40	25
ABAIS40089	Ø89	3.147,813	40	25
ABAIS40114	Ø114	4.905,683	40	10
ABAIS40133	Ø133	5.294,053	40	10
ABAIS40140	Ø140	5.723,297	40	10
ABAIS40159	Ø159	6.540,913	40	10
ABAIS40168	Ø168	6.949,720	40	10
ABAIS40219	Ø219	8.380,543	40	5

AB-AIS 40

40 mm



AB-GA

Abrazadera gásmica M8 + M10 amarilla



02 Info
Técnica
p. 393

M8
Ø 18-34 mm.
M8/M10
Ø 60-160 mm.

REFORZADA



De acuerdo a
UNE-EN ISO 4892



CÓDIGO	MEDIDA	€/100	MEDIDA EN PULGADAS	ØD(MM)	CARGA MÁXIMA		
ABGA018	18 (M8)	102,813	3/8"	15 - 18	200	50	300
ABGA022	22 (M8)	108,380	1/2"	20 - 24	200	50	200
ABGA028	28 (M8)	115,230	3/4"	26 - 30	200	50	150
ABGA035	35 (M8)	123,540	1"	32 - 36	200	50	100
ABGA040	40 (M8)	129,953	1 1/4"	38 - 42	200	50	100
ABGA048	48 (M8)	136,523	1 1/2"	47 - 50	200	50	100
ABGA054	54 (M8)	145,377	-	52 - 56	200	25	75
ABGA060	60 (M8/M10)	155,553	2"	60 - 64	200	25	75
ABGA075	75 (M8/M10)	185,890	2 1/2"	75 - 80	200	25	50
ABGA090	90 (M8/M10)	196,443	3"	85 - 90	200	25	-
ABGA100	100 (M8/M10)	215,857	3 1/2"	99 - 105	200	25	-
ABGA110	110 (M8/M10)	244,457	-	107 - 112	200	25	-
ABGA115	115 (M8/M10)	247,777	4"	113 - 118	200	25	-
ABGA140	140 (M8/M10)	290,790	5"	138 - 142	200	25	-
ABGA160	160 (M8/M10)	306,830	6"	159 - 166	200	25	-



Bolsa Autoservicio

CÓDIGO	MEDIDA	€/BOLSA	PCS.	BOLSAS
LSABGAT022	22	5,126	2	6
LSABGAT028	28	5,233	2	6
LSABGAT035	35	5,148	2	6
LSABGAT040	40	5,541	2	6
LSABGAT048	48	5,438	2	6
LSABGAT060	60	5,817	2	6
LSABGAT075	75	6,232	2	6
LSABGAT090	90	6,827	2	6
LSABGAT110	110	9,232	2	5

KIT
AB-GA + ES-DR
+ T4S



EJEMPLOS DE APLICACIÓN



AB-M8

Abrazadera desagüe M8



02 Info
Técnica
p. 393

DESAGÜE



CÓDIGO	MEDIDA	€/100	ØD(MM)	CARGA MÁXIMA	
ABM8050	50 (M8)	150,260	49 - 54	100	100
ABM8063	63 (M8)	147,580	60 - 65	100	100
ABM8075	75 (M8)	158,830	75 - 80	100	100
ABM8090	90 (M8)	169,857	88 - 92	100	100
ABM8110	110 (M8)	187,827	108 - 113	100	100
ABM8125	125 (M8)	197,013	124 - 130	100	100
ABM8160	160 (M8)	244,303	159 - 165	100	100
ABM8200	200 (M8)	290,057	199 - 203	100	100
ABM8250	250 (M8)	370,703	249 - 254	100	50
ABM8315	315 (M8)	803,800	314 - 319	100	50



Bolsa Autoservicio

CÓDIGO	MEDIDA	€/BOLSA	PCS.	BOLSAS
LSABM8090	90	4,056	2	6
LSABM8110	110	4,233	2	6
LSABM8125	125	2,893	1	8
LSABM8160	160	3,722	1	4

Abrazadera desagüe de empotrar

AB-DE



CÓDIGO	MEDIDA	€/100	ØD(MM)	CARGA MÁXIMA	
ABDE075	75	215,537	75 - 80	200	100
ABDE090	90	233,353	87 - 92	200	100
ABDE110	110	281,963	107 - 112	200	100
ABDE125	125	317,617	125 - 130	200	50

AB-DE Z

Cincada



02
P. 394
Info.
Técnica



CÓDIGO	MEDIDA	€/100	ØD(MM)	CARGA MÁXIMA	
ABDE160	160	369,470	159 - 166	200	50
ABDE200	200	444,013	199 - 212	200	50
ABDE250	250	713,013	245 - 254	200	25
ABDE315	315	894,513	314 - 319	200	25

AB-DE G

Recubrimiento ATLANTIS C2-L



02
P. 394
Info.
Técnica

EJEMPLOS DE APLICACIÓN



REFORZADA



Abrazadera desagüe con pie

AB-DP



CÓDIGO	MEDIDA	€/100	ØD(MM)	CARGA MÁXIMA	
ABDP075	75	246,317	75 - 80	200	100
ABDP090	90	269,003	87 - 92	200	100
ABDP110	110	294,277	107 - 112	200	100
ABDP125	125	330,580	125 - 130	200	50

AB-DP Z

Cincada



02
P. 394
Info.
Técnica



CÓDIGO	MEDIDA	€/100	ØD(MM)	CARGA MÁXIMA	
ABDP160	160	395,397	159 - 166	200	50
ABDP200	200	466,700	199 - 212	200	25
ABDP250	250	648,200	245 - 254	200	25

AB-DP G

Recubrimiento ATLANTIS C2-L



02
P. 394
Info.
Técnica

EJEMPLOS DE APLICACIÓN



REFORZADA



AB-ZI

Abarcón

AB-ZI

Cincada



02
P. 395
Info.
Técnica

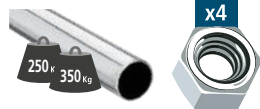

CÓDIGO	MEDIDA	€/100	Ø VARILLA PULGADAS	CARGA MÁXIMA		
AZIM060250	M6 1/4"	28,983	1/4"	250	100	800
AZIM060375	M6 3/8"	29,997	3/8"	250	100	1.200
AZIM060500	M6 1/2"	34,423	1/2"	250	100	600
AZIM060750	M6 3/4"	40,737	3/4"	250	100	600
AZIM061000	M6 1"	43,750	1"	250	100	400
AZIM061250	M6 1 1/4"	58,523	1 1/4"	250	50	300
AZIM081500	M8 1 1/2"	90,850	1 1/2"	350	50	150
AZIM082000	M8 2"	103,557	2"	350	50	150
AZIM082250	M8 2 1/4"	120,603	2 1/4"	350	50	100
AZIM082500	M8 2 1/2"	127,087	2 1/2"	350	50	100
AZIM083000	M8 3"	136,270	3"	350	50	100
AZIM083500	M8 3 1/2"	162,327	3 1/2"	350	50	100
AZIM084000	M8 4"	200,350	4"	350	50	100
AZIM084500	M8 4 1/2"	211,897	4 1/2"	350	25	100
AZIM085000	M8 5"	219,310	5"	350	25	100
AZIM086000	M8 6"	249,333	6"	350	25	100
AZIM103000	M10 3"	186,747	3"	350	25	50
AZIM103500	M10 3 1/2"	214,407	3 1/2"	350	25	50
AZIM104000	M10 4"	240,840	4"	350	25	100
AZIM105000	M10 5"	267,033	5"	350	25	100
AZIM106000	M10 6"	308,883	6"	350	25	100
AZIM108000	M10 8"	351,467	8"	350	25	100

AB-ZI A2

Inoxidable A2



CÓDIGO	MEDIDA	€/100	Ø VARILLA PULGADAS	CARGA MÁXIMA		
AZA2060500	M6 1/2"	105,883	1/2"	250	100	600
AZA2060750	M6 3/4"	123,093	3/4"	250	100	600
AZA2061000	M6 1"	151,650	1"	250	100	400
AZA2061250	M6 1 1/4"	179,560	1 1/4"	250	50	300
AZA2081500	M8 1 1/2"	312,037	1 1/2"	350	50	150
AZA2082000	M8 2"	362,937	2"	350	50	150
AZA2082500	M8 2 1/2"	408,927	2 1/2"	350	50	100
AZA2083000	M8 3"	444,473	3"	350	50	100
AZA2104000	M10 4"	904,320	4"	350	50	-
AZA2106000	M10 6"	1.166,313	6"	350	25	-
AZA2108000	M10 8"	1.395,300	8"	350	25	-

Soporte de abarcón

AB-SA



CÓDIGO	MEDIDA	€/100	LONGITUD	
ABSA050100	50 x 100	491,121	100	50
ABSA050125	50 x 125	532,261	125	50
ABSA050200	50 x 200	650,676	200	25
ABSA050300	50 x 300	786,859	300	25
ABSA050400	50 x 400	961,330	400	25
ABSA050500	50 x 500	1.404,436	500	10
ABSA050600	50 x 600	1.541,632	600	10
ABSA100100	100 x 100	652,425	100	25
ABSA100125	100 x 125	699,904	125	25
ABSA100200	100 x 200	827,277	200	25
ABSA100300	100 x 300	1.049,165	300	10
ABSA100400	100 x 400	1.403,332	400	10
ABSA100500	100 x 500	1.834,349	500	10



Abrazadera de gran presión

AB-GP



CÓDIGO	MEDIDA	€/100	ØD(MM)		
AGP023025	23-25	158,223	23 - 25	50	300
AGP026028	26-28	164,517	26 - 28	50	300
AGP029031	29-31	197,710	29 - 31	50	200
AGP032035	32-35	203,113	32 - 35	50	150
AGP036039	36-39	204,470	36 - 39	50	150
AGP040043	40-43	216,623	40 - 43	50	100
AGP044047	44-47	283,990	44 - 47	50	-
AGP048051	48-51	296,437	48 - 51	25	75
AGP052055	52-55	302,983	52 - 55	25	75
AGP056059	56-59	310,183	56 - 59	25	75
AGP060063	60-63	323,287	60 - 63	25	50
AGP064067	64-67	354,267	64 - 67	25	50
AGP068073	68-73	436,403	68 - 73	25	-
AGP074079	74-79	441,807	74 - 79	25	-
AGP080085	80-85	446,400	80 - 85	25	-
AGP086091	86-91	454,863	86 - 91	25	-
AGP092097	92-97	476,937	92 - 97	25	-
AGP098103	98-103	481,883	98 - 103	25	-
AGP104112	104-112	523,323	104 - 112	25	-
AGP113121	113-121	558,900	113 - 121	25	-
AGP122130	122-130	599,883	122 - 130	25	-
AGP131139	131-139	748,500	131 - 139	25	-
AGP140148	140-148	764,710	140 - 148	25	-
AGP149161	149-161	810,207	149 - 161	25	-
AGP162174	162-174	845,777	162 - 174	25	-



EJEMPLOS DE APLICACIÓN



Blister

CÓDIGO	MEDIDA	€/BOLSA	PCS.	BOLSAS
BZAGP023025	23-25	4,622	2	10
BZAGP029031	29-31	4,622	2	10
BZAGP040043	40-43	4,622	2	10





ABRAZADERAS METÁLICAS LIGERAS



MEDIDAS (mm)	CARGA RECOMENDADA kg	RECUBRIMIENTO	ESPESOR (mm)	ANCHURA (mm)	APERTURA	MANGUITO	HOMOLOGACIÓN	ISOFÓNICA	CTE	MONTAJE EN PARALELO	TORNILLO
--------------	----------------------	---------------	--------------	--------------	----------	----------	--------------	-----------	-----	---------------------	----------



AB-M6 AB-M6 Z APLICACIONES: Gas, Saneamiento, Eléctrico P. 250

	Ø 8 - Ø 63	70 - 100	 AB-M6 AB-M6 Z	1 - 1,2	12	Rápida lateral	Embutida M6	-	-	-	-
--	------------	----------	--	---------	----	----------------	-------------	---	---	---	---



AB-M7 Z APLICACIONES: Gas Saneamiento Eléctrico P. 253

	Ø 8 - Ø 63	70		0,8 - 1	11	-	Embutida M7	-	-	-	-
--	------------	----	---	---------	----	---	-------------	---	---	---	---





AB-D6 AB-D6 Z APLICACIONES: Gas, Saneamiento, Eléctrico P. 251

	Ø 12 - Ø 28	100	 AB-D6 AB-D6 Z	1	12	-	Embutida M6	-	-		-
--	-------------	-----	--	---	----	---	-------------	---	---	---	---





AB-DZ 7 APLICACIONES: Gas, Saneamiento, Eléctrico P. 253

	Ø 10 - Ø 28	70		0,8 - 1	11	-	Embutida M7	-	-		-
--	-------------	----	--	---------	----	---	-------------	---	---	---	---





AB-6I APLICACIONES: ACS y AF, Gas, Saneamiento, Calefacción, Climatización, Eléctrico, Ventilación P. 252

	Ø 12 - Ø 60	70 - 100		1 - 1,2	12	Rápida lateral	Embutida M6	-			-
--	-------------	----------	---	---------	----	----------------	-------------	---	---	---	---





AB-DI APLICACIONES: ACS y AF, Gas, Saneamiento, Calefacción, Climatización, Eléctrico, Ventilación P. 252

	Ø 12 - Ø 60	100		1	12	-	Embutida M6	-			
--	-------------	-----	---	---	----	---	-------------	---	---	---	---



AB-7I Z APLICACIONES: ACS y AF, Gas, Saneamiento, Calefacción, Climatización, Eléctrico, Ventilación P. 254

	Ø 12 - Ø 50	70		0,8 - 1	11	-	Embutida M7	-			-
--	-------------	----	---	---------	----	---	-------------	---	---	---	---



AB-7ID Z APLICACIONES: ACS y AF, Gas, Saneamiento, Calefacción, Climatización, Eléctrico, Ventilación P. 254



























	Ø 10 - Ø 28	70		0,8 - 1	11	-	Embutida M7	-			
--	-------------	----	---	---------	----	---	-------------	---	---	---	---

AB-PI APLICACIONES: Saneamiento, Eléctrico P. 255

	Ø 6 - Ø 63	30		1,1 - 1,3	12,5 - 19	-	-	-	-	-	-
--	------------	----	---	-----------	-----------	---	---	---	---	---	---

AB-PU APLICACIONES: Saneamiento, Eléctrico P. 255

	Ø 16 - Ø 63	30		1,2 - 1,4	12 - 20	-	-	-	-	-	-
--	-------------	----	---	-----------	---------	---	---	---	---	---	---

MEDIDAS (mm)	CARGA RECOMENDADA kg	RECUBRIMIENTO	ESPESOR (mm)	ANCHURA (mm)	APERTURA	MANGUITO	HOMOLOGACIÓN	ISOFÓNICA	CTE	MONTAJE EN PARALELO	TORNILLO	
AB-GM APLICACIONES: Gas P. 260												
	Ø 12 - Ø 35	100		1 - 1,2	12	Rápida lateral	Embutida M6	De acuerdo a UNE-EN ISO 4892	-	-	-	Premontado
AB-GS APLICACIONES: Gas P. 261												
	Ø 10 - Ø 54	70 - 100		1 - 1,2	12	Rápida lateral	Embutida M6	De acuerdo a UNE-EN ISO 4892	-	-	-	Premontado
AB-GD APLICACIONES: Gas P. 261												
	Ø 12 - Ø 28	100		1 - 1,2	12	-	Embutida M6	De acuerdo a UNE-EN ISO 4892	-	-		Premontado
AB-CR APLICACIONES: Saneamiento P. 259												
	Ø 10 - Ø 12	70		1 - 1,2	12	Rápida lateral	Embutida M6	-	-	-	-	-
AB-ITS P. 259												
	15 - 28	-		1,0 - 1,2	20 - 33	-	-	-	-	-	-	-
AB-ITD P. 259												
	15 - 22	-		1,0	20 - 27	-	-	-	-	-	-	-
AB-BU APLICACIONES: Saneamiento, Industrial P. 260												
	Ø 13 - Ø 21	-		0,6	9	-	-	-	-	-	-	Premontado
AB-SF APLICACIONES: Saneamiento, Industrial P. 257												
	Ø 8 - Ø 150	-		0,6 - 0,8	9	-	-	-	-	-	-	Premontado
AB-IP APLICACIONES: ACS y AF, Gas, Saneamiento, Calefacción, Climatización, Eléctrico, Ventilación P. 256												
	-	-		1,5	20	-	-	-			-	ABT006015
AB-SI APLICACIONES: ACS y AF, Gas, Saneamiento, Calefacción, Climatización, Eléctrico, Ventilación P. 256												
	3 / 25 Agujeros	-		3	20	-	-	-				ABT006015

AB-M6

Abrazadera M6

AB-M6

Bicromatada



02
P. 396
Info
Técnica

APERTURA LATERAL



CÓDIGO	MEDIDA	€/100	MEDIDA EN PULGADAS	Ø(DMM)	CARGA MÁXIMA		
ABM6008	8 (M6)	19,570	-	8	70	100	1.200
ABM6010	10 (M6)	20,263	1/8"	10	70	100	1.200
ABM6012	12 (M6)	20,020	-	12	70	100	1.200
ABM6014	14 (M6)	20,717	1/4"	14	70	100	1.200
ABM6015	15 (M6)	20,720	-	15	70	100	600
ABM6016	16 (M6)	21,307	-	16	70	100	600
ABM6018	18 (M6)	21,823	3/8"	18	70	100	600
ABM6020	20 (M6)	22,150	-	20	70	100	600
ABM6022	22 (M6)	23,153	1/2"	22	70	100	600
ABM6025	25 (M6)	24,320	-	25	70	100	600
ABM6026	26 (M6)	25,580	3/4"	26	70	100	400
ABM6028	28 (M6)	26,197	-	28	70	100	400
ABM6032	32 (M6)	29,010	1"	32	70	50	300
ABM6035	35 (M6)	32,607	-	35	70	50	300
ABM6037	37 (M6)	34,380	-	37	100	50	300
ABM6040	40 (M6)	37,340	-	40	100	50	300
ABM6042	42 (M6)	38,727	1 1/4"	42	100	50	300
ABM6047	47 (M6)	42,110	1 1/2"	47	100	50	200
ABM6050	50 (M6)	42,280	-	50	100	50	150
ABM6054	54 (M6)	49,160	-	54	100	50	150
ABM6060	60 (M6)	53,803	2"	60	100	50	150
ABM6063	63 (M6)	56,817	-	63	100	50	100



Bolsa Autoservicio

CÓDIGO	MEDIDA	€/BOLSA	PCS.	BOLSAS
LSABM6012	12	6,190	20	5
LSABM6014	14	6,309	20	5
LSABM6016	16	6,423	20	5
LSABM6018	18	5,361	15	6
LSABM6022	22	4,476	10	6
LSABM6028	28	3,266	6	6
LSABM6032	32	2,902	4	6
LSABM6040	40	3,330	4	5

AB-M6 Z

Cincada



02
P. 396
Info
Técnica

APERTURA LATERAL



CÓDIGO	MEDIDA	€/100	MEDIDA EN PULGADAS	Ø(DMM)	CARGA MÁXIMA		
ABMZ6008	8 (M6)	19,570	-	8	70	100	1.200
ABMZ6010	10 (M6)	20,263	1/8"	10	70	100	1.200
ABMZ6012	12 (M6)	20,020	-	12	70	100	1.200
ABMZ6014	14 (M6)	20,717	1/4"	14	70	100	1.200
ABMZ6015	15 (M6)	21,107	-	15	70	100	600
ABMZ6016	16 (M6)	21,307	-	16	70	100	600
ABMZ6018	18 (M6)	21,823	3/8"	18	70	100	600
ABMZ6020	20 (M6)	22,150	-	20	70	100	600
ABMZ6022	22 (M6)	23,153	1/2"	22	70	100	600
ABMZ6025	25 (M6)	24,320	-	25	70	100	600
ABMZ6026	26 (M6)	25,580	3/4"	26	70	100	400
ABMZ6028	28 (M6)	26,197	-	28	70	100	400
ABMZ6032	32 (M6)	29,010	1"	32	70	50	300
ABMZ6035	35 (M6)	32,607	-	35	70	50	300
ABMZ6037	37 (M6)	35,027	-	37	100	50	300
ABMZ6040	40 (M6)	37,340	-	40	100	50	300
ABMZ6042	42 (M6)	38,727	1 1/4"	42	100	50	300
ABMZ6047	47 (M6)	42,110	1 1/2"	47	100	50	200
ABMZ6050	50 (M6)	42,280	-	50	100	50	150
ABMZ6054	54 (M6)	49,160	-	54	100	50	150
ABMZ6060	60 (M6)	53,803	2"	60	100	50	150
ABMZ6063	63 (M6)	56,817	-	63	100	50	100

Abrazadera M6

AB-M6

INOXIDABLE



CÓDIGO	MEDIDA	€/100	MEDIDA EN PULGADAS	ØD(MM)	CARGA MÁXIMA		
ABM6A2012	12 (M6)	198,680	1/4"	12	70	100	1.200
ABM6A2015	15 (M6)	202,270	-	14 - 15	70	100	600
ABM6A2018	18 (M6)	205,860	3 / 8"	16 - 18	70	100	600
ABM6A2020	20 (M6)	209,980	1 / 2"	19 - 21	70	100	600
ABM6A2022	22 (M6)	212,633	-	22 - 24	70	100	600
ABM6A2028	28 (M6)	224,573	3/4"	25 - 30	70	100	400

AB-M6 A2

Inoxidable A2



02 Info. Técnica p. 397

Abrazadera doble M6

AB-D6



CÓDIGO	MEDIDA	€/100	MEDIDA EN PULGADAS	ØD(MM)	CARGA MÁXIMA		
ABD6012	12 (M6)	31,177	-	12	100	50	600
ABD6015	15 (M6)	33,967	-	15	100	50	300
ABD6018	18 (M6)	37,313	3/8"	18	100	50	300
ABD6022	22 (M6)	42,313	1/2"	22	100	50	300
ABD6028	28 (M6)	49,600	-	28	100	50	200

AB-D6

Bicromatada



02 Info. Técnica p. 397



Bolsa Autoservicio

CÓDIGO	MEDIDA	€/BOLSA	PCS.	BOLSAS
LSABD6012	12	3,404	5	6
LSABD6015	15	3,515	5	6
LSABD6018	18	3,616	5	6
LSABD6022	22	3,515	4	6
LSABD6028	28	4,321	4	6

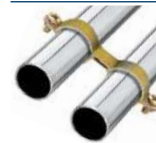

CÓDIGO	MEDIDA	€/100	MEDIDA EN PULGADAS	ØD(MM)	CARGA MÁXIMA		
ABDZ6012	12 (M6)	31,177	-	12	100	50	600
ABDZ6015	15 (M6)	33,967	-	15	100	50	300
ABDZ6018	18 (M6)	37,313	3/8"	18	100	50	300
ABDZ6022	22 (M6)	42,313	1/2"	22	100	50	300
ABDZ6028	28 (M6)	49,600	-	28	100	50	200

AB-D6 Z

Cincada



02 Info. Técnica p. 397

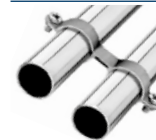

EJEMPLOS DE APLICACIÓN



AB-6I

Abrazadera isofónica M6



02 Info. Técnica
p. 398

APERTURA LATERAL



CTE
CÓDIGO TÉCNICO DE LA EDIFICACIÓN



CÓDIGO	MEDIDA	€/100	MEDIDA EN PULGADAS	ØD(MM)	CARGA MÁXIMA		
AB6I012	12 (M6)	30,567	1/8"	12	70	100	600
AB6I015	15 (M6)	31,420	1/4"	15	70	100	600
AB6I016	16 (M6)	32,813	-	16	70	100	600
AB6I018	18 (M6)	33,100	3/8"	18	70	100	600
AB6I022	22 (M6)	37,663	1/2"	22	70	100	400
AB6I026	26 (M6)	42,690	-	26	70	100	400
AB6I028	28 (M6)	44,413	3/4"	28	70	100	300
AB6I032	32 (M6)	46,503	-	32	70	50	200
AB6I035	35 (M6)	52,437	1"	35	70	50	200
AB6I042	42 (M6)	64,830	1 1/4"	42	100	50	150
AB6I048	48 (M6)	73,393	1 1/2"	48	100	50	100
AB6I054	54 (M6)	86,683	-	54	100	50	100
AB6I060	60 (M6)	92,080	2"	60	100	50	100



Bolsa Autoservicio

CÓDIGO	MEDIDA	€/BOLSA	PCS.	BOLSAS
LSAB6I012	12	5,038	10	6
LSAB6I015	15	5,297	10	5
LSAB6I016	16	5,327	10	6
LSAB6I018	18	4,314	8	6
LSAB6I022	22	3,936	6	6
LSAB6I028	28	3,448	4	6

AB-DI

Abrazadera doble isofónica M6



02 Info. Técnica
p. 398

CTE
CÓDIGO TÉCNICO DE LA EDIFICACIÓN

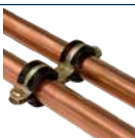

CÓDIGO	MEDIDA	€/100	MEDIDA EN PULGADAS	ØD(MM)	CARGA MÁXIMA		
ABDI0012	12 (M6)	54,810	1/8"	12	100	50	300
ABDI0015	15 (M6)	65,373	1/4"	15	100	50	300
ABDI0018	18 (M6)	71,337	3/8"	18	100	50	200
ABDI0022	22 (M6)	82,167	1/2"	22	100	50	200
ABDI0028	28 (M6)	107,233	3/4"	28	100	50	150



Bolsa Autoservicio

CÓDIGO	MEDIDA	€/BOLSA	PCS.	BOLSAS
LSABDI0012	12	3,970	5	6
LSABDI0015	15	4,194	5	6
LSABDI0018	18	3,414	3	6
LSABDI0022	22	3,565	3	6

Abrazadera M7. Cincada.

AB-M7 Z



CÓDIGO	MEDIDA	€/100	ØD(MM)		
ABMZ7008	8	19,570	8	100	1.200
ABMZ7010	10	20,263	10	100	1.200
ABMZ7012	12	20,020	12	100	1.200
ABMZ7014	14	20,717	14	100	1.200
ABMZ7016	16	21,307	16	100	1.200
ABMZ7018	18	21,823	18	100	1.200
ABMZ7020	20	22,150	20	100	1.200
ABMZ7022	22	23,153	22	100	600
ABMZ7024	24	23,627	24	100	600
ABMZ7025	25	24,320	25	100	600
ABMZ7026	26	25,580	26	100	600
ABMZ7028	28	26,197	28	100	600
ABMZ7032	32	29,010	32	50	600
ABMZ7034	34	32,260	34	50	300
ABMZ7036	36	34,380	36	50	300
ABMZ7038	38	34,323	38	50	300
ABMZ7040	40	37,340	40	50	300
ABMZ7050	50	42,280	50	50	200
ABMZ7063	63	56,817	63	25	150



02
P. 399
Info.
Técnica



Abrazadera doble M7. Cincada.

AB-D7 Z



CÓDIGO	MEDIDA	€/100	ØD(MM)		
ABDZ70810	8-10	31,750	8-10	50	600
ABDZ71012	10-12	31,177	10-12	50	600
ABDZ71214	12-14	34,647	12-14	50	600
ABDZ71416	14-16	33,967	14-16	50	600
ABDZ71618	16-18	37,313	16-18	50	600
ABDZ71820	18-20	42,313	18-20	50	300
ABDZ72022	20-22	49,600	20-22	50	300
ABDZ72224	22-24	51,220	22-24	50	300
ABDZ72628	26-28	53,823	26-28	50	300



02
P. 399
Info.
Técnica



AB-7I Z

Abrazadera isofónica M7. Cincada.



02
P. 400

Info.
Técnica



CÓDIGO	MEDIDA	€/100	ØD(MM)		
AB7IZ010	10	29,130	10	100	1.200
AB7IZ012	12	30,567	12	100	1.200
AB7IZ014	14	31,420	14	100	1.200
AB7IZ016	16	32,813	16	100	1.200
AB7IZ018	18	33,100	18	100	600
AB7IZ020	20	35,713	20	100	600
AB7IZ022	22	37,663	22	100	600
AB7IZ024	24	38,880	24	100	600
AB7IZ026	26	42,690	26	100	600
AB7IZ028	28	44,413	28	100	400
AB7IZ032	32	46,503	32	50	300
AB7IZ034	34	50,100	34	50	300
AB7IZ036	36	52,437	36	50	300
AB7IZ038	38	52,730	38	50	300
AB7IZ040	40	58,563	40	50	300
AB7IZ050	50	61,060	50	50	200

AB-7ID Z

Abrazadera doble isofónica M7. Cincada.



02
P. 400

Info.
Técnica



CÓDIGO	MEDIDA	€/100	ØD(MM)		
AB7IDZ0810	08-10	51,247	08-10	50	600
AB7IDZ1012	10-12	54,810	10-12	50	600
AB7IDZ1214	12-14	56,560	12-14	50	600
AB7IDZ1416	14-16	65,373	14-16	50	300
AB7IDZ1618	16-18	71,337	16-18	50	300
AB7IDZ1820	18-20	72,320	18-20	50	300
AB7IDZ2022	20-22	82,167	20-22	50	300
AB7IDZ2224	22-24	86,990	22-24	50	200
AB7IDZ2628	26-28	107,233	26-28	50	200

Grapa 1 pie

AB-PI



CÓDIGO	MEDIDA	€/100	MEDIDA EN PULGADAS	ØD(MM)	CARGA MÁXIMA		
ABPI006	6	6,293	-	6	30	100	2.400
ABPI008	8	6,730	-	8	30	100	2.400
ABPI010	10	7,477	1/8"	10	30	100	2.400
ABPI012	12	7,890	1/4"	12	30	100	2.400
ABPI014	14	9,907	-	14	30	100	2.400
ABPI016	16	12,123	3/8"	16	30	100	1.200
ABPI018	18	13,160	-	18	30	100	1.200
ABPI020	20	15,640	1/2"	20	30	100	1.200
ABPI022	22	17,097	-	22	30	100	600
ABPI025	25	19,067	-	25	30	100	600
ABPI026	26	19,723	3/4"	26	30	100	600
ABPI028	28	20,710	-	28	30	100	600
ABPI032	32	28,290	1"	32	30	100	600
ABPI040	40	38,780	-	40	30	50	300
ABPI042	42	45,723	1 1/4"	42	30	50	300
ABPI047	47	47,650	1 1/2"	47	30	50	200
ABPI050	50	49,287	-	50	30	50	200
ABPI063	63	73,883	2"	63	30	50	200



02 Info. Técnica
P. 401



EJEMPLOS DE APLICACIÓN



Blister

CÓDIGO	MEDIDA	€/BOLSA	PCS.	BOLSAS
BZABPI016	16	2,029	2	15
BZABPI018	18	2,029	2	12
BZABPI020	20	2,029	2	10
BZABPI022	22	2,029	2	10
BZABPI025	25	2,029	2	10
BZABPI028	28	2,029	2	10
BZABPI032	32	2,029	2	10

Bolsa Autoservicio

CÓDIGO	MEDIDA	€/BOLSA	PCS.	BOLSAS
LSABPI016	16	4,658	20	5
LSABPI018	18	4,789	20	5
LSABPI020	20	4,977	20	5
LSABPI022	22	5,449	20	5
LSABPI025	25	4,985	15	5
LSABPI028	28	4,214	10	6
LSABPI032	32	3,491	6	6
LSABPI040	40	3,310	4	6

Grapa puente

AB-PU



CÓDIGO	MEDIDA	€/100	MEDIDA EN PULGADAS	ØD(MM)	CARGA MÁXIMA		
ABPU016	16	15,267	3/8"	16	75	100	1.200
ABPU018	18	15,993	-	18	75	100	1.200
ABPU020	20	16,173	1/2"	20	75	100	600
ABPU022	22	19,520	-	22	75	100	600
ABPU025	25	20,573	-	25	75	100	600
ABPU028	28	22,223	-	28	75	100	600
ABPU032	32	25,153	1"	32	75	50	300
ABPU037	37	30,093	-	37	75	50	300
ABPU040	40	35,243	-	40	75	50	300
ABPU050	50	45,920	-	50	75	50	200
ABPU063	63	62,260	2"	63	75	50	150



02 Info. Técnica
P. 401



EJEMPLOS DE APLICACIÓN



Bolsa Autoservicio

CÓDIGO	MEDIDA	€/BOLSA	PCS.	BOLSAS
LSABPU016	16	5,072	20	5
LSABPU018	18	5,362	20	5
LSABPU020	20	5,451	20	5
LSABPU022	22	6,173	20	5
LSABPU025	25	5,420	15	5
LSABPU028	28	4,510	10	6
LSABPU032	32	3,321	6	6
LSABPU037	37	2,981	4	6
LSABPU040	40	3,023	4	6
LSABPU050	50	3,405	4	6
LSABPU063	63	3,703	4	6

AB-IP

Grapa puente isofónica para montaje



02 Info Técnica P. 402

CTE

CÓDIGO TÉCNICO DE LA EDIFICACIÓN

CÓDIGO	MEDIDA	€/100	MEDIDA EN PULGADAS	Ø(DMM)	Nº AGUJEROS		
ABIP015	15	59,943	-	15	3	50	600
ABIP018	18	66,050	3/8"	18	3	50	300
ABIP022	22	72,473	1/2"	22	3	50	300
ABIP026	26	84,703	3/4"	26	4	50	300
ABIP028	28	90,553	-	28	4	50	300
ABIP035	35	102,987	1"	35	4	50	150
ABIP042	42	112,023	1 1/4"	42	4	25	100
ABIP048	48	121,063	1 1/2"	48	4	25	100
ABIP054	54	134,667	-	54	5	25	100
ABIP060	60	151,663	2"	60	5	25	75
ABIP067	67	168,673	-	67	5	25	75
ABIP075	75	179,943	2 1/2"	75	6	25	75
ABIP090	90	212,657	3"	90	6	25	75

AB-SI

Soporte para grapa puente isofónica



AB-SI

Soporte para grapa puente isofónica



02 Info Técnica P. 402

CTE

CÓDIGO TÉCNICO DE LA EDIFICACIÓN

CÓDIGO	MEDIDA	€/100	MÉTRICA TALADRO	Nº AGUJEROS	
ABSI003	3	203,633	M6	25	-
ABSI004	4	237,047	M6	25	-
ABSI005	5	272,483	M6	25	150
ABSI006	6	306,817	M6	25	-
ABSI007	7	343,273	M6	25	-
ABSI008	8	376,910	M6	25	-
ABSI009	9	410,773	M6	25	-
ABSI010	10	430,530	M6	25	-
ABSI011	11	470,753	M6	25	-
ABSI012	12	505,973	M6	25	-
ABSI013	13	538,987	M6	25	-
ABSI014	14	566,570	M6	25	-
ABSI015	15	602,243	M6	25	-
ABSI016	16	636,150	M6	10	-
ABSI017	17	684,683	M6	10	-
ABSI018	18	743,453	M6	10	-
ABSI019	19	752,150	M6	10	-
ABSI020	20	810,883	M6	10	-
ABSI021	21	819,500	M6	10	-
ABSI022	22	854,737	M6	10	-
ABSI025	25	1.008,880	M6	10	-

AB-TO

Tornillo para montaje AB-IP



CÓDIGO	MEDIDA	€/100	
ABTO06015	M6 x 15	9,090	100

EJEMPLOS DE APLICACIÓN



Abrazadera sin fin

AB-SF



CÓDIGO	MEDIDA	€/100	MEDIDA EN PULGADAS	Ø(MM)		
ASF008016	8-16	31,963	5/16"- 5/8"	8-16	100	1.200
ASF012022	12-22	32,983	1/2"- 7/8"	12-22	100	600
ASF016027	16-27	34,727	5/8"- 1 1/16"	16 - 27	100	600
ASF020032	20-32	38,940	3/4"- 1 1/4"	20 - 32	100	600
ASF025040	25-40	45,430	1"- 1 5/8"	25 - 40	100	400
ASF030045	30-45	50,717	1 3/16"- 1 3/4"	30 - 45	100	300
ASF035050	35-50	51,013	1 3/8"- 2"	35 - 50	100	200
ASF040060	40-60	59,080	1 5/8"- 2 3/8"	40 - 60	100	200
ASF050070	50-70	65,503	2"- 2 3/4"	50 - 70	50	100
ASF060080	60-80	68,673	2 3/8"- 3 1/8"	60 - 80	50	100
ASF070090	70-90	75,717	2 3/4"- 3 1/2"	70 - 90	50	-
ASF080100	80-100	81,763	3 1/8"- 4"	80 - 100	50	-
ASF090110	90-110	90,667	3 1/2"- 4 3/8"	90 - 110	50	-
ASF100120	100-120	99,507	4"- 4 3/4"	100 - 120	25	-
ASF110130	110-130	102,357	4 3/8"- 5 1/8"	110 - 130	25	-
ASF120140	120-140	108,950	4 3/4"- 5 1/2"	120 - 140	25	-
ASF130150	130-150	112,707	5 1/8"- 5 7/8"	130 - 150	25	-

AB-SF

Cincada



02 Info. Técnica P. 403

Arandela estampada

Para varios Ø



EJEMPLOS DE APLICACIÓN



Blister



Bolsa Autoservicio

CÓDIGO	MEDIDA	€/BOLSA	PCS.	BOLSAS
BZASF008016	8-16	2,565	2	20
BZASF012022	12-22	2,565	2	20
BZASF016027	16-27	2,565	2	20
BZASF020032	20-32	2,565	2	10
BZASF025040	25-40	2,565	2	10

CÓDIGO	MEDIDA	€/BOLSA	PCS.	BOLSAS
LSASF008016	8-16	7,246	15	7
LSASF012022	12-22	6,336	12	7
LSASF016027	16-27	6,493	12	7
LSASF020032	20-32	6,171	10	7
LSASF025040	25-40	4,300	6	7
LSASF030045	30-45	4,742	6	7
LSASF035050	35-50	4,783	6	7
LSASF040060	40-60	3,925	4	7
LSASF050070	50-70	4,195	4	7

INOXIDABLE



CÓDIGO	MEDIDA	€/100	MEDIDA EN PULGADAS		
ASF2010016	10-16	91,983	-	100	1.200
ASF2012020	12-20	94,273	1/2"- 7/8"	100	600
ASF2016027	16-27	98,337	5/8"- 1 1/16"	100	600
ASF2020032	20-32	110,910	3/4"- 1 1/4"	100	600
ASF2025040	25-40	121,187	1"- 1 5/8"	100	200
ASF2032050	32-50	168,677	1 3/8"- 2"	100	300
ASF2040060	40-60	179,097	1 5/8"- 2 3/8"	100	200
ASF2050070	50-70	186,910	2"- 2 3/4"	50	100
ASF2060080	60-80	196,483	2 3/8"- 3 1/8"	50	100
ASF2070090	70-90	206,930	2 3/4"- 3 1/2"	50	100
ASF2080100	80-100	213,867	3 1/8"- 4"	50	100
ASF2090110	90-110	249,403	3 1/2"- 4 3/8"	50	50
ASF2100120	100-120	259,197	4"- 4 3/4"	25	25
ASF2110130	110-130	268,960	4 3/8"- 5 1/8"	25	25
ASF2120140	120-140	282,660	4 3/4"- 5 1/2"	25	25
ASF2130150	130-150	293,423	5 1/8"- 5 7/8"	25	25

AB-SF A2

Inoxidable A2



02 Info. Técnica P. 403

Arandela estampada

Para varios Ø



EJEMPLOS DE APLICACIÓN



AB-SF IR

Abrazadera sin fin inoxidable en rollo

AB-SF IR

Kit



CÓDIGO	MEDIDA	€/PC		
ASFIR03	9 x 0,6 mm/ 3 m	1.429,560	1	50

AB-SF IRC

Cabezal



CÓDIGO	MEDIDA	€/100		
ASFIRCA	Cabezal	102,113	50	1.000

AB-SF IRR

30 metros



CÓDIGO	MEDIDA	€/PC		
ASFIR30	9 x 0,6 mm/ 30 m	5.105,580	1	10

CI-PE

Cinta perforada

CI-PE

Cinta perforada curva. ATLANTIS C2-M



02 Info. Técnica p. 403



CÓDIGO	MEDIDA	€/PC	UD. MIN. VENTA		
CIPE1208	12 x 0,8 x 10 m	8,370	10	1	40
CIPE1708	17 x 0,8 x 10 m	11,261	10	1	30



CI-PE A2

Cinta perforada curva. Inoxidable A2



02 Info. Técnica p. 403

INOXIDABLE



CÓDIGO	MEDIDA	€/PC	UD. MIN. VENTA		
CIPEA21708	17 x 0,8 x 10 m	40,304	1	1	30



Cinta perforada recta ATLANTIS C2-M

CI-PR



CÓDIGO	MEDIDA	€/PC	UD. MIN. VENTA		
CIPR1908	19 x 0,8 x 10 m	12,647	5	1	30
CIPR1208	12 x 0,8 x 10 m	9,109	5	1	40



02
P. 404
Info.
Técnica

Abrazadera cromada M6

AB-CR



CÓDIGO	MEDIDA	€/100	MEDIDA EN PULGADAS	CARGA MÁXIMA		
ABCR010	10 (M6)	34,563	1/8"	70	100	1.200
ABCR012	12 (M6)	36,417	1/4"	70	100	1.200



02
P. 404
Info.
Técnica

EJEMPLOS DE APLICACIÓN



Abrazadera inoxidable Indextube

AB-IT

SANEAMIENTO



CÓDIGO	MEDIDA	€/100		
ABITS015	Ø15	122,600	100	600
ABITS018	Ø18	132,847	100	400
ABITS022	Ø22	196,913	100	400
ABITS028	Ø28	264,693	100	300

AB-ITS **NEW**

Simple



SANEAMIENTO



CÓDIGO	MEDIDA	€/100		
ABITD015	Ø15	453,273	50	300
ABITD018	Ø18	513,180	50	200
ABITD022	Ø22	201,960	50	100

AB-ITD **NEW**

Doble



AB-BU

Abrazadera butano



CÓDIGO	MEDIDA	€/100	MEDIDA EN PULGADAS		
ABBU1315	13 - 15	34,077	1/2" - 9/16"	50	600
ABBU1618	16 - 18	34,077	5/8" - 11/16"	50	600
ABBU1921	19 - 21	46,322	3/4" - 13/16"	50	600

02 Info. Técnica P. 404

EJEMPLOS DE APLICACIÓN



AB-GM

Abrazadera gásmica con tirafondo amarilla



CÓDIGO	MEDIDA	€/100	MEDIDA EN PULGADAS	ØD(MM)	CARGA MÁXIMA		
ABGM012	12 (M6)	37,060	1/4"	12	70	100	600
ABGM015	15 (M6)	39,316	-	15	70	100	600
ABGM018	18 (M6)	40,391	3/8"	18	70	100	600
ABGM022	22 (M6)	42,653	1/2"	22	70	50	200
ABGM028	28 (M6)	45,039	3/4"	28	70	50	200
ABGM035	35 (M6)	54,260	-	35	70	50	200

02 Info. Técnica P. 405



De acuerdo a UNE-EN ISO 4892

EJEMPLOS DE APLICACIÓN



Abrazadera gásmica negra M6 con tirafondo

AB-GS



CÓDIGO	MEDIDA	€/100	MEDIDA EN PULGADAS	ØD(MM)	CARGA MÁXIMA		
ABGS010	10 (M6)	36,347	1/8"	10	70	100	600
ABGS012	12 (M6)	36,990	1/4"	12	70	100	600
ABGS015	15 (M6)	37,810	-	15	70	100	600
ABGS018	18 (M6)	38,860	3/8"	18	70	100	600
ABGS022	22 (M6)	42,617	1/2"	22	70	50	200
ABGS028	28 (M6)	44,990	3/4"	28	70	50	200
ABGS035	35 (M6)	52,167	-	35	70	50	200
ABGS042	42 (M6)	57,550	1 1/4"	42	100	25	100
ABGS054	54 (M6)	77,587	-	54	100	25	100



02 Info. Técnica P. 405

APERTURA LATERAL



De acuerdo a UNE-EN ISO 4892



Bolsa Autoservicio

CÓDIGO	MEDIDA	€/BOLSA	PCS.	BOLSAS
LSABGS015	15	6,465	10	6
LSABGS018	18	5,341	8	6
LSABGS022	22	4,854	6	6

Abrazadera gásmica negra doble M6 con tirafondo

AB-GD



CÓDIGO	MEDIDA	€/100	MEDIDA EN PULGADAS	ØD(MM)	CARGA MÁXIMA		
ABGD012	12 (M6)	50,317	-	12	100	50	300
ABGD015	15 (M6)	54,327	-	15	100	50	300
ABGD018	18 (M6)	55,820	3/8"	18	100	50	300
ABGD022	22 (M6)	60,913	1/2"	22	100	50	200
ABGD028	28 (M6)	82,477	-	28	100	50	200



02 Info. Técnica P. 405



De acuerdo a UNE-EN ISO 4892

EJEMPLOS DE APLICACIÓN





SISTEMAS PROTECCIÓN CONTRA INCENDIOS



Wingz®
ICE
CE CAT. II
HYPERBALLAST™
EN 379 EN 531
3232 020
N100
SIZE M/B

AB-PE

Abrazadera colgante pera



02 Info. Técnica
P. 406



CÓDIGO	MEDIDA	€/100	MEDIDA EN PULGADAS	CARGA MÁXIMA		
ABPE028	28 (M10)	97,553	3/4"	154	50	200
ABPE035	35 (M10)	102,313	1"	186	50	200
ABPE040	40 (M10)	119,767	1 1/4"	195	50	200
ABPE048	48 (M10)	120,427	1 1/2"	236	50	200
ABPE060	60 (M10)	136,417	2"	288	50	200
ABPE075	75 (M10)	157,753	2 1/2"	426	25	100
ABPE090	90 (M10)	177,657	3"	481	25	100
ABPE100	100 (M10)	218,937	3 1/2"	569	25	100
ABPE115	115 (M10)	296,180	4"	669	25	100
ABPE140	140 (M12)	527,704	5"	907	10	40
ABPE160	160 (M12)	616,561	6"	1.186	10	40
ABPE220	220 (M12)	1.078,984	8"	1.723	10	40

EJEMPLOS DE APLICACIÓN



AB-CH

Abrazadera para tubería Clevis



02 Info. Técnica
P. 406



CÓDIGO	HOMOLOGACIÓN	MEDIDA	€/100	ØD(MM)	
ABCH00034	UL	3/4"	296,283	28	50
ABCH01000	UL	1"	312,697	35	50
ABCH01014	UL	1 1/4"	314,647	42	50
ABCH01012	UL	1 1/2"	339,727	48	50
ABCH02000	UL	2"	347,883	60	50
ABCH02012	UL & FM	2 1/2"	633,767	75	30
ABCH03000	UL & FM	3"	653,843	90	25
ABCH04000	UL & FM	4"	1.200,317	115	25
ABCH05000	UL & FM	5"	1.665,253	140	25
ABCH06000	UL & FM	6"	2.356,850	160	10
ABCH08000	UL	8"	3.532,940	220	10
ABCH10000	UL	10"	6.025,677	275	1
ABCH12000	UL	12"	7.998,550	325	1
ABCH14000	-	14"	10.330,123	355	1
ABCH16000	-	16"	14.837,133	405	1

Collarín intumescente

AB-CI





CÓDIGO	MEDIDA	€/PC	
ABCIKIT25	2,5 m x 50 mm	484,512	1
ABCIKIT30 NEW	3 m x 50 mm	572,727	1

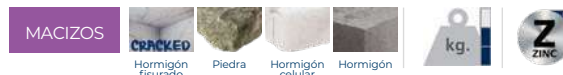

Anclaje metálico tipo cuña. Homologado ETE

AN-CU



CÓDIGO	MEDIDA	€/100	Ø BROCA		
ANCU06040	6 x 40 Ø6	28,713	6	100	1.200
ANCU06070	6 x 70 Ø6	45,007	6	100	1.200





SOPORTES DE CANALÓN



TE

Soportes de canalón

TE-MO

Módulo para canal de PVC



CÓDIGO	D (MM)	A (MM)	€/100	
TEM025	100	60	255,990	50
TEM033	150	80	315,510	50

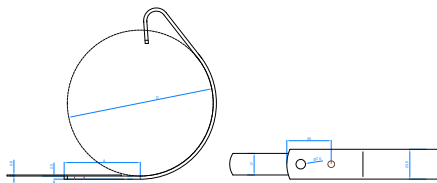

TE-GA

Gancho para canal de PVC



CÓDIGO	D (MM)	€/100	
TEGA25	100	385,920	50
TEGA33	150	403,197	50

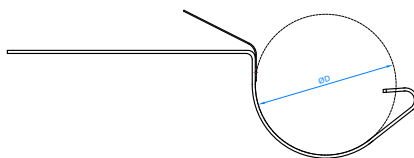

TE-GR

Placa teja grande



CÓDIGO	A (MM)	B (MM)	L (MM)	€/100	
TEGR2530	35	50	80	250,030	50

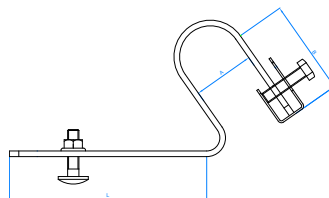

TE-PE

Placa teja



CÓDIGO	A (MM)	B (MM)	L (MM)	€/100	
TEPE2530	22	50	100	233,480	50

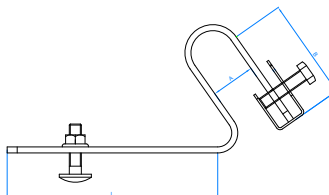

EJEMPLOS DE APLICACIÓN





ABRAZADERAS PLÁSTICAS



Las bridas de Nylon® y sus accesorios son uno de los productos de mayor demanda en el mundo de la instalación profesional. Están indicadas para todo tipo de aplicaciones, tales como instalaciones eléctricas, jardinería, cableado industrial, construcción, DIY, cadenas de fabricación o instalaciones fotovoltaicas. La gama de bridas de INDEX está compuesta de una amplia variedad de colores y tamaños, bridas detectables y accesorios varios. Contamos con la certificación UNE-EN 62275 (marcado CE) y con la homologación UL.



CUALIDADES Y VENTAJAS



INSTALACIÓN RÁPIDA Y SENCILLA

El diseño ergonómico de la cola flexible de la brida facilita un enhebrado fácil y suave.



ALTAS PRESTACIONES

El diseño del cabezal garantiza una alta resistencia a la tracción, garantizando un fuerte tensado. Hasta 122,3 Kg* de carga de rotura según EN 50146.

*En brida con anchura de 12 mm.



DENTADO INTERIOR

El diseño del dentado interior asegura un óptimo ajuste de la brida sin dañar el objeto a fijar.



MÁXIMA CALIDAD Y GARANTÍAS

La calidad de las bridas de INDEX está garantizada con los más altos estándares de calidad, gracias a la certificación de acuerdo con la norma UNE-EN 62275, que permite el marcado CE y con homologación UL.

APLICACIONES



- Cableados en general:
- Cableados eléctricos, sujeción de mangueras, agrupación de mangueras de cables
- Plantas Solares
- Automoción y Aeronáutica
- Embalaje de Productos
- Parques Infantiles
- Industria Farmacéutica y Alimentación
- Bricolaje y Jardinería
- Arte y Manualidades
- Instalaciones con requisitos HACCP/APPCC (bridas desechables)

GAMA



BRIDAS BLANCAS Y NEGRAS

Las bridas de Nylon® blancas y negras de dentado interior son muy versátiles, ya que sirven para numerosos usos en múltiples industrias. Están disponibles en una gran variedad de tamaños, permitiendo una óptima fijación del elemento a fijar, ya sean mazos de cables, tubos y/o mangueras.

Las bridas negras, fabricadas con poliamida y aditivo negro, disponen de una mayor resistencia a la radiación ultravioleta, siendo aptas para aplicaciones en exterior. Las bridas blancas (naturales) están indicadas para aplicaciones en interior.

Son idóneas para uso en instalaciones donde sea necesaria una alta resistencia a álcalis, aceites, grasas, derivados del aceite o disolventes clorados. Por el contrario, tienen una resistencia limitada a ácidos y no son resistentes a fenoles.



BRIDAS DE COLORES

Las bridas de colores están indicadas para el cableado en cajas de conexión en las que se agrupan distintos mazos de cables, permitiendo identificarlos de manera rápida y sencilla y posibilitando ordenar visualmente el espacio de trabajo. También se utilizan en aquellas aplicaciones donde se requiera que las bridas pasen desapercibidas (vallados).

Disponibles en una amplia gama de medidas en color **marrón, amarillo, azul, rojo, verde y gris**.



BRIDAS DETECTABLES

Las bridas detectables están especialmente diseñadas para la utilización en la industria alimentaria, cosmética, farmacéutica y en todas aquellas que sean aplicaciones donde se deben **cumplir los requisitos de la metodología HACCP* o APPCC** (Análisis de Peligros y Puntos Críticos de Control).

Fabricadas en Poliamida 6.6 con partículas metálicas, disponen de **propiedades magnéticas que permiten la detección** con un detector de metales, así como por equipos de inspección de rayos X. Además, su particular color azul facilita su detección visual.



PACKAGING Y PUNTO DE VENTA



La bolsa donde se venden las bridas dispone de toda la información necesaria de un solo vistazo.

En la etiqueta está impreso las dimensiones de la brida, la temperatura de uso, el tamaño mínimo y máximo de diámetro, la tensión soportada, código o EAN. Se trata de una bolsa de plástico de alta calidad que garantiza su estanqueidad para mantener el contenido de humedad recomendada.

Las bridas se presentan tres opciones de presentación en lineal:



BOLSAS COLGADAS EN GANCHOS



BOLSAS COLOCADAS EN BANDEJAS



BOLSAS EN CAJAS EXPOSITOARIAS

RECOMENDACIONES DE USO Y ALMACENAJE DE LAS BRIDAS

Las bridas de INDEX están fabricadas en poliamida de alta calidad, un material plástico higroscópico, es decir, que el material absorbe y pierde agua en función de las condiciones externas (humedad y temperatura). Para garantizar una correcta manipulación y una óptima conservación de la poliamida, las bolsas de bridas contienen el nivel de humedad adecuado.

Recomendamos seguir las siguientes indicaciones para un correcto comportamiento del producto:



No abrir la bolsa hasta el momento de usarlas y una vez abiertas utilizarlas lo antes posible o bien almacenarlas en bolsas de plástico herméticas.



No almacenar cerca de fuentes de calor.



Condiciones óptimas de almacenamiento: 23°C de temperatura y 50% de humedad relativa.



No exponer directamente al sol.



Bridas de nylon. Negra

BN-N

MULTIMATERIAL



CÓDIGO	MEDIDA	€/100					
BN25080	2,5 x 80	1,557	100	1.000	60.000		
BN25100	2,5 x 100	1,780	100	1.000	50.000		
BN25140	2,5 x 140	2,637	100	1.000	50.000		
BN25160	2,5 x 160	2,927	100	1.000	50.000		
BN25200	2,5 x 200	3,810	100	1.000	35.000		
BN36140	3,6 x 140	3,643	100	1.000	30.000		
BN36200	3,6 x 200	4,960	100	1.000	25.000		
BN36250	3,6 x 250	6,733	100	1.000	12.000		
BN36300	3,6 x 300	8,063	100	1.000	12.000		
BN36370	3,6 x 370	10,927	100	1.000	12.000		
BN48120	4,8 x 120	5,313	100	1.000	23.000		
BN48160	4,8 x 160	5,910	100	1.000	23.000		
BN48180	4,8 x 180	6,303	100	1.000	16.000		
BN48200	4,8 x 200	6,447	100	1.000	16.000		
BN48250	4,8 x 250	9,310	100	1.000	12.000		
BN48290	4,8 x 290	10,083	100	1.000	11.000		
BN48370	4,8 x 370	12,997	100	1.000	8.000		
BN48430	4,8 x 430	18,397	100	1.000	8.000		
BN76150	7,6 x 150	14,313	100	1.000	12.000		
BN76200	7,6 x 200	15,333	100	1.000	9.000		
BN76290	7,6 x 290	19,303	100	1.000	5.000		
BN76370	7,6 x 370	25,060	100	1.000	5.000		
BN76450	7,6 x 450	38,170	100	1.000	3.000		
BN76540	7,6 x 540	47,193	100	1.000	3.000		
BN88770	8,8 x 770	83,663	50	1.000	1.000		
BN12225	12,5 x 225	54,673	50	500	2.000		
BN12500	12,5 x 500	115,390	50	-	1.000		
BN12720	12,5 x 720	163,910	50	-	1.000		
BN12850	12,5 x 850	189,547	50	-	1.000		
BN12100	12,5 x 1.000	232,730	50	-	1.000		



Blister

CÓDIGO	MEDIDA	€/BOLSA	PCS.	BOLSAS
BZBN25100	2,5 x 100	2,029	20	20
BZBN25160	2,5 x 160	2,029	20	20
BZBN25200	2,5 x 200	2,029	20	20
BZBN36140	3,6 x 140	2,029	20	20
BZBN36200	3,6 x 200	2,029	20	20
BZBN36300	3,6 x 300	2,565	20	15
BZBN48160	4,8 x 160	2,565	20	15
BZBN48200	4,8 x 200	2,565	20	15
BZBN48290	4,8 x 290	2,565	10	15
BZBN48370	4,8 x 370	2,565	10	15



Caja Expositora

CÓDIGO	MEDIDA	€/CAJA	PCS.	CAJAS
CKBN25080	2,5 x 080	1,633	100	30
CKBN25100	2,5 x 100	1,864	100	30
CKBN25140	2,5 x 140	2,766	100	30
CKBN25160	2,5 x 160	3,069	100	20
CKBN25200	2,5 x 200	3,996	100	20
CKBN36140	3,6 x 140	3,821	100	20
CKBN36200	3,6 x 200	5,207	100	20
CKBN36300	3,6 x 300	8,467	100	10
CKBN36370	3,6 x 370	11,469	100	10
CKBN48120	4,8 x 120	5,583	100	20
CKBN48160	4,8 x 160	6,206	100	20
CKBN48180	4,8 x 180	6,613	100	20
CKBN48200	4,8 x 200	6,772	100	20
CKBN48250	4,8 x 250	9,780	100	10
CKBN48290	4,8 x 290	10,583	100	10
CKBN48370	4,8 x 370	13,642	100	10
CKBN76200	7,6 x 200	16,099	100	10
CKBN76290	7,6 x 290	20,270	100	10
CKBN76370	7,6 x 370	26,311	100	8
CKBN12225	12,5 x 225	28,701	50	10



BN-B

Bridas de nylon. Blanca

MULTIMATERIAL



CÓDIGO	MEDIDA	€/100						
BB25080	2,5 x 80	1,557	100	1.000	60.000			
BB25100	2,5 x 100	1,780	100	1.000	50.000			
BB25140	2,5 x 140	2,637	100	1.000	50.000			
BB25160	2,5 x 160	2,927	100	1.000	50.000			
BB25200	2,5 x 200	3,810	100	1.000	35.000			
BB36140	3,6 x 140	3,643	100	1.000	30.000			
BB36200	3,6 x 200	4,960	100	1.000	25.000			
BB36250	3,6 x 250	6,733	100	1.000	12.000			
BB36300	3,6 x 300	8,063	100	1.000	12.000			
BB36370	3,6 x 370	10,927	100	1.000	12.000			
BB48120	4,8 x 120	5,313	100	1.000	23.000			
BB48160	4,8 x 160	5,910	100	1.000	23.000			
BB48180	4,8 x 180	6,303	100	1.000	16.000			
BB48200	4,8 x 200	6,447	100	1.000	16.000			
BB48250	4,8 x 250	9,310	100	1.000	12.000			
BB48290	4,8 x 290	10,083	100	1.000	11.000			
BB48370	4,8 x 370	12,997	100	1.000	8.000			
BB48430	4,8 x 430	18,397	100	1.000	8.000			
BB76150	7,6 x 150	14,313	100	1.000	12.000			
BB76200	7,6 x 200	15,333	100	1.000	9.000			
BB76290	7,6 x 290	19,303	100	1.000	5.000			
BB76370	7,6 x 370	25,060	100	1.000	5.000			
BB76450	7,6 x 450	38,170	100	1.000	3.000			
BB76540	7,6 x 540	47,193	100	1.000	3.000			
BB88770	8,8 x 770	83,663	50	1.000	1.000			
BB12225	12,5 x 225	54,673	50	500	2.000			
BB12500	12,5 x 500	115,390	50	-	1.000			
BB12720	12,5 x 720	163,910	50	-	1.000			
BB12850	12,5 x 850	189,547	50	-	1.000			
BB12100	12,5 x 1.000	232,730	50	-	1.000			



Blister

CÓDIGO	MEDIDA	€/BOLSA	PCS. 	BOLSAS
BZBB25100	2,5 x 100	2,029	20	20
BZBB25160	2,5 x 160	2,029	20	20
BZBB25200	2,5 x 200	2,029	20	20
BZBB36140	3,6 x 140	2,029	20	20
BZBB36200	3,6 x 200	2,029	20	20
BZBB36300	3,6 x 300	2,565	20	15
BZBB48160	4,8 x 160	2,565	20	15
BZBB48200	4,8 x 200	2,565	20	15
BZBB48290	4,8 x 290	2,565	10	15
BZBB48370	4,8 x 370	2,565	10	15



Caja Expositora

CÓDIGO	MEDIDA	€/CAJA	PCS. 	CAJAS
CKBB25080	2,5 x 080	1,633	100	30
CKBB25100	2,5 x 100	1,864	100	30
CKBB25140	2,5 x 140	2,766	100	30
CKBB25160	2,5 x 160	3,069	100	20
CKBB25200	2,5 x 200	3,996	100	20
CKBB36140	3,6 x 140	3,821	100	20
CKBB36200	3,6 x 200	5,207	100	20
CKBB36300	3,6 x 300	8,467	100	10
CKBB36370	3,6 x 370	11,469	100	10
CKBB48120	4,8 x 120	5,583	100	20
CKBB48160	4,8 x 160	6,206	100	20
CKBB48180	4,8 x 180	6,613	100	20
CKBB48200	4,8 x 200	6,772	100	20
CKBB48250	4,8 x 250	9,780	100	20
CKBB48290	4,8 x 290	10,583	100	10
CKBB48370	4,8 x 370	13,642	100	10
CKBB76200	7,6 x 200	16,099	100	10
CKBB76290	7,6 x 290	20,270	100	10
CKBB76370	7,6 x 370	26,311	100	8
CKBB12225	12,5 x 225	28,701	50	8



TACOBRI N

Taco para bridas. Negro



MULTIMATERIAL



CÓDIGO	TALADRO	COLOR	€/100	Ø BROCA		
TACOBRI N6	Ø6		6,537	6	100	5.000
TACOBRI N8	Ø8		6,130	8	100	5.000



Blister

CÓDIGO	MEDIDA	€/BOLSA	PCS. 	BOLSAS
BZTACOBRI N8		2,029	4	15



Caja Expositora

CÓDIGO	MEDIDA	€/CAJA	PCS. 	CAJAS
CKTACOBRI N6	6	6,860	100	10
CKTACOBRI N8	8	6,434	100	10



Taco para bridas. Blanco

TACOBRI B

MULTIMATERIAL



CÓDIGO	TALADRO	COLOR	€/100	Ø BROCA		
TACOBRI B6	Ø6		6,680	6	100	5.000
TACOBRI B8	Ø8		6,130	8	100	5.000



Blister



Caja Expositora

CÓDIGO	MEDIDA	€/BOLSA	PCS.	BOLSAS
BZTABRI B8		2,029	4	15

CÓDIGO	MEDIDA	€/CAJA	PCS.	CAJAS
CKTACOBRI B6	6	7,014	100	10
CKTACOBRI B8	8	6,434	100	10

Bridas de nylon colores. Gris

BN-GR

MULTIMATERIAL



CÓDIGO	MEDIDA	€/100		
BC25100GR	2,5 x 100	1,997	100	50.000
BC36140GR	3,6 x 140	3,647	100	30.000
BC36200GR	3,6 x 200	5,130	100	25.000
BC48200GR	4,8 x 200	6,517	100	16.000
BC48290GR	4,8 x 290	10,237	100	11.000



Taco para bridas

TACOBRI G

MULTIMATERIAL



CÓDIGO	TALADRO	COLOR	€/100	Ø BROCA		
TACOBRI G8	M4 x 10		8,043	8	100	5.000



Brida detectable

BN-DT

MULTIMATERIAL



CÓDIGO	MEDIDA	€/100		
BNDT25100	2,5 x 100	3,543	100	50.000
BNDT36150	3,6 x 150	8,267	100	30.000
BNDT36200	3,6 x 200	10,627	100	25.000
BNDT48200	4,8 x 200	12,987	100	16.000
BNDT48300	4,8 x 300	20,070	100	11.000
BNDT48370	4,8 x 370	28,337	100	8.000
BNDT76370	7,6 x 370	51,950	100	5.000

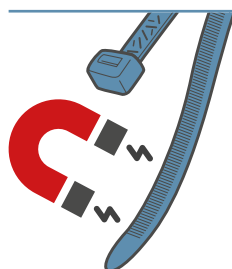

BRIDA DETECTABLE con partículas metálicas

- TRIPLE DETECCIÓN:



MAGNÉTICA



RAYOS X



VISUAL

- COMPATIBLE COMO PARTE DEL PROCESO HACCP*/APPCC**.

*HACCP: Hazard Analysis and Critical Control Points). Sistema de inocuidad alimentaria basado en la identificación de todos los peligros potenciales en los ingredientes y los distintos procesos de producción de los alimentos.

** APPCC: Análisis de Peligros y Puntos Críticos de Control.

BN-ID

Bridas de nylon con identificación



MULTIMATERIAL



CÓDIGO	MEDIDA	€/100		
BID25110	2,5 x 110	11,797	100	16.000
BID25210	2,5 x 210	25,953	100	12.000

BN-PL

Placa de identificación de nylon de hasta 4,8 mm



MULTIMATERIAL



CÓDIGO	MEDIDA	€/100		
BPL02616	26,4 x 16,2	27,813	100	5.000

BN-BA

Base de dos vías adhesivas para bridas de nylon



MULTIMATERIAL



CÓDIGO	MEDIDA	COLOR	€/100		
BBANA19	19 x 19		25,430	100	15.000
BBANA27	27 x 27		36,380	100	6.000
BBANE19	19 x 19		25,430	100	15.000
BBANE27	27 x 27		36,380	100	6.000

BN-CO

Bridas de nylon colores

BN-VE

Verde



MULTIMATERIAL



CÓDIGO	MEDIDA	€/100		
BC25100VE	2,5 x 100	1,820	100	50.000
BC36140VE	3,6 x 140	4,610	100	30.000
BC36200VE	3,6 x 200	5,923	100	25.000
BC48200VE	4,8 x 200	8,117	100	16.000
BC48290VE	4,8 x 290	12,120	100	11.000

Caja Expositora

CÓDIGO	MEDIDA	€/CAJA	PCS. 	CAJAS
CKBC25100VE	2,5 x 100	1,912	100	30
CKBC36140VE	3,6 x 140	4,845	100	20
CKBC36200VE	3,6 x 200	6,216	100	20
CKBC48200VE	4,8 x 200	8,522	100	20
CKBC48290VE	4,8 x 290	12,727	100	10



Bridas de nylon colores

BN-CO

MULTIMATERIAL



CÓDIGO	MEDIDA	€/100		
BC25100MA	2,5 x 100	1,820	100	50.000
BC36140MA	3,6 x 140	4,610	100	30.000
BC36200MA	3,6 x 200	5,923	100	25.000
BC48200MA	4,8 x 200	8,117	100	16.000
BC48290MA	4,8 x 290	12,120	100	11.000

Caja Expositora

CÓDIGO	MEDIDA	€/CAJA	PCS. 	CAJAS
CKBC25100MA	2,5 x 100	1,912	100	30
CKBC36140MA	3,6 x 140	4,845	100	20
CKBC36200MA	3,6 x 200	6,216	100	20
CKBC48200MA	4,8 x 200	8,522	100	18
CKBC48290MA	4,8 x 290	12,727	100	10

BN-MA

Marrón



MULTIMATERIAL



CÓDIGO	MEDIDA	€/100		
BC25100AM	2,5 x 100	1,820	100	50.000
BC36140AM	3,6 x 140	4,610	100	30.000
BC36200AM	3,6 x 200	5,923	100	25.000
BC48200AM	4,8 x 200	8,117	100	16.000
BC48290AM	4,8 x 290	12,120	100	11.000

BN-AM

Amarilla



MULTIMATERIAL



CÓDIGO	MEDIDA	€/100		
BC25100AZ	2,5 x 100	1,820	100	50.000
BC36140AZ	3,6 x 140	4,610	100	30.000
BC36200AZ	3,6 x 200	5,923	100	25.000
BC48200AZ	4,8 x 200	8,117	100	16.000
BC48290AZ	4,8 x 290	12,120	100	11.000

BN-AZ

Azul



Caja Expositora

CÓDIGO	MEDIDA	€/CAJA	PCS. 	CAJAS
CKBC25100AZ	2,5 x 100	1,912	100	30
CKBC36140AZ	3,6 x 140	4,845	100	20
CKBC36200AZ	3,6 x 200	6,216	100	20
CKBC48200AZ	4,8 x 200	8,522	100	18
CKBC48290AZ	4,8 x 290	12,727	100	10

MULTIMATERIAL



CÓDIGO	MEDIDA	€/100		
BC25100RO	2,5 x 100	1,820	100	50.000
BC36140RO	3,6 x 140	4,610	100	30.000
BC36200RO	3,6 x 200	5,923	100	25.000
BC48200RO	4,8 x 200	8,117	100	16.000
BC48290RO	4,8 x 290	12,120	100	11.000

BN-RO

Rojo



Caja Expositora

CÓDIGO	MEDIDA	€/CAJA	PCS. 	CAJAS
CKBC25100RO	2,5 x 100	1,912	100	30
CKBC36140RO	3,6 x 140	4,845	100	20
CKBC36200RO	3,6 x 200	6,216	100	20
CKBC48200RO	4,8 x 200	8,522	100	18
CKBC48290RO	4,8 x 290	12,727	100	10

AB-IN

Clip simple de polipropileno con casquillo de latón M6



02 Info. Técnica
P. 407



Libre de halógenos



Resistencia UV



M6

BRASS



CÓDIGO	MEDIDA	€/100	ØD(MM)	CARGA MÁXIMA		
ABIN012	12	32,807	12	10	100	1.200
ABIN014	14-15	35,677	14-15	10	100	600
ABIN016	16-18	44,897	16-18	10	100	600
ABIN020	20-22	47,020	20-22	10	100	400
ABIN025	25	59,583	25	10	50	300
ABIN028	28	60,840	28	10	50	300
ABIN032	32	81,560	32	10	25	150
ABIN035	35	92,550	35	10	25	300



Bolsa Autoservicio

CÓDIGO	MEDIDA	€/BOLSA	PCS.	BOLSAS
LSABIN012	12	5,788	10	6
LSABIN014	14-15	6,060	10	5
LSABIN016	16-18	5,630	8	6
LSABIN020	20-22	4,887	6	5
LSABIN028	28	4,456	4	6

INSTALACIÓN

PERFIL



AB-ID

Clip doble de polipropileno con casquillo de latón M6



02 Info. Técnica
P. 407



Libre de halógenos



Resistencia UV



M6

BRASS



CÓDIGO	MEDIDA	€/100	ØD(MM)	CARGA MÁXIMA		
ABID012	12	64,683	12	10	50	200
ABID014	14-15	67,900	14-15	10	50	300
ABID016	16-18	86,640	16-18	10	50	200
ABID020	20-22	91,780	20-22	10	50	150
ABID028	28	113,317	28	10	25	100



Bolsa Autoservicio

CÓDIGO	MEDIDA	€/BOLSA	PCS.	BOLSAS
LSABID012	12	5,964	6	6
LSABID014	14-15	6,207	6	5
LSABID016	16-18	3,626	2	6
LSABID020	20-22	3,729	2	6
LSABID028	28	4,177	2	6

INSTALACIÓN

PERFIL



EJEMPLOS DE APLICACIÓN





Abrazadera guía simple con pre-rosca M6

AB-GU



CÓDIGO	MEDIDA	€/100	ØD(MM)	CARGA MÁXIMA		
ABGUG15	15	22,653	15	40	100	400
ABGUG18	18	22,880	18	40	100	400
ABGUG20	20	24,083	20	40	100	400
ABGUG22	22	25,510	22	40	100	300
ABGUG25	25	28,343	25	40	50	300
ABGUG28	28	35,453	28	40	50	200
ABGUG32	32	38,603	32	40	25	150
ABGUG40	40	51,343	40	40	25	150
ABGUG50	50	61,570	50	40	25	100



02 Info Técnica P. 407



Bolsa Autoservicio

CÓDIGO	MEDIDA	€/BOLSA	PCS.	BOLSAS
LSABGUG15	15	3,472	8	6
LSABGUG18	18	3,181	6	6
LSABGUG20	20	2,727	4	7
LSABGUG22	22	2,852	4	7
LSABGUG25	25	2,519	2	6
LSABGUG28	28	2,561	2	6
LSABGUG32	32	2,685	2	6
LSABGUG40	40	2,893	2	6
LSABGUG50	50	3,102	2	6

INSTALACIÓN



Abrazadera multidímetro

AB-MUG



CÓDIGO	MEDIDA	€/100	CARGA MÁXIMA		
ABMUG15	15-16	21,130	40	100	400
ABMUG18	18-20	26,637	40	100	400
ABMUG22	22-25	31,643	40	100	300
ABMUG26	26-28	39,523	40	50	150
ABMUG32	32-35	51,007	40	50	150
ABMUG40	40-42	69,007	40	50	100
ABMUG48	48-50	82,947	40	25	75



02 Info Técnica P. 408



Bolsa Autoservicio

CÓDIGO	MEDIDA	€/BOLSA	PCS.	BOLSAS
LSABMUG15	15-16	3,487	8	6
LSABMUG18	18-20	3,387	6	6
LSABMUG22	22-25	3,015	4	7
LSABMUG26	26-28	2,582	2	6
LSABMUG32	32-35	2,829	2	6

INSTALACIÓN



AB-PR

Abrazadera a presión con pre-rosca M6



02
P. 394
Info
Técnica



CÓDIGO	MEDIDA	€/100	ØD(MM)	CARGA MÁXIMA		
ABPRG15	15-18	24,493	15-18	10	100	400
ABPRG20	20-22	25,287	20-22	10	100	400
ABPRG25	25-28	30,603	25-28	10	100	300
ABPRG32	32-35	43,130	32-35	10	25	150
ABPRG40	40	55,667	40	10	25	150
ABPRG50	50	70,163	50	10	25	100

Bolsa Autoservicio

CÓDIGO	MEDIDA	€/BOLSA	PCS. 	BOLSAS
LSABPRG15	15-18	3,825	8	6
LSABPRG20	20-22	3,042	4	5
LSABPRG25	25-28	2,850	3	6

INSTALACIÓN

PERFIL

PISTOLA

TACO + TORNILLO



AB-MS

Abrazadera multitubo + taco. Simple



02
P. 408
Info
Técnica



CÓDIGO	ØD(MM)	MEDIDA	€/100	MEDIDA TORNILLO		
ABMS10	10	5 x 20 Ø5	28,150	3,5x35	100	1.200
ABMS12	12	5 x 20 Ø5	30,007	3,5x35	100	1.200
ABMS14	14	6 x 25 Ø6	41,827	4x45	100	600
ABMS16	16	6 x 25 Ø6	43,170	4x45	100	600
ABMS18	18	8 x 30 Ø8	56,770	4,5x50	100	300
ABMS20	20	8 x 30 Ø8	58,120	4,5x50	50	300
ABMS22	22	8 x 30 Ø8	59,410	4,5x50	50	300
ABMS26	26	10 x 40 Ø10	111,817	6x60	50	150
ABMS28	28	10 x 40 Ø10	113,607	6,5x60	50	150

AB-MD

Abrazadera multitubo + taco. Doble



02
P. 409
Info
Técnica



CÓDIGO	ØD(MM)	MEDIDA	€/100	MEDIDA TORNILLO		
ABMD10	10	8 x 30 Ø8	55,667	4,5x50	100	300
ABMD12	12	8 x 30 Ø8	56,800	4,5x50	100	300
ABMD14	14	8 x 30 Ø8	57,933	4,5x50	100	300
ABMD16	16	8 x 30 Ø8	57,023	4,5x50	100	300
ABMD18	18	10 x 40 Ø10	80,563	6x60	100	200
ABMD20	20	10 x 40 Ø10	85,513	6x60	50	150
ABMD22	22	10 x 40 Ø10	88,077	6x60	50	150
ABMD26	26	10 x 40 Ø10	140,603	6x60	50	100
ABMD28	28	10 x 40 Ø10	141,680	6x60	50	100



Taco para fijación de tubo INDEXring

AB-T



CÓDIGO	MEDIDA	€/100	MEDIDA EN PULGADAS	ØD(MM)	CARGA MÁXIMA		
ABTS014	14	27,887	-	14 - 15	30	100	600
ABTS016	16	28,890	3/8"	16 - 17	30	100	400
ABTS018	18	31,220	-	18 - 19	30	100	400
ABTS020	20	31,743	1/2"	20 - 21	30	100	300
ABTS022	22	32,553	-	22 - 23	30	100	300
ABTS025	25	33,610	3/4"	25 - 26	30	100	300
ABTS028	28	39,900	-	28 - 29	30	100	200
ABTS032	30	51,427	-	30 - 32	30	50	150



Bolsa Autoservicio

CÓDIGO	MEDIDA	€/BOLSA	PCS.	BOLSAS
LSABTS018	18	3,808	6	6
LSABTS022	22	4,056	6	6

AB-TS

Simple



02 Info. Técnica P. 409



CÓDIGO	MEDIDA	€/100	MEDIDA EN PULGADAS	ØD(MM)	CARGA MÁXIMA		
ABTD016	16	34,007	3/8"	15 - 16	30	100	400
ABTD018	18	38,667	-	18 - 19	30	100	300
ABTD020	20	39,587	1/2"	20 - 21	30	100	200
ABTD022	22	42,630	-	22 - 23	30	100	200
ABTD025	25	46,417	3/4"	25 - 26	30	100	200
ABTD028	28	61,863	-	28 - 29	30	50	150



Bolsa Autoservicio

CÓDIGO	MEDIDA	€/BOLSA	PCS.	BOLSAS
LSABTD018	18	3,550	4	6
LSABTD022	22	2,659	2	7

AB-TD

Doble



02 Info. Técnica P. 409



CÓDIGO	MEDIDA	€/100	MEDIDA EN PULGADAS	ØD(MM)	CARGA MÁXIMA		
ABTC020	20	65,867	1/2"	20 - 21	30	50	100
ABTC025	25	80,987	3/4"	25 - 26	30	50	100

AB-TC

Cuádruple



02 Info. Técnica P. 410



EJEMPLOS DE APLICACIÓN



FI-CA

Fijaciones para cables

FI-CA AB

Abrazadera



CÓDIGO	MEDIDA	€/100	
FICAAB080	80	160,000	50
FICAAB119	119	266,667	25

FI-CA PS

Pinza simple



CÓDIGO	MEDIDA	€/100	
FICAPS080	80	76,667	50

FI-CA PD

Pinza doble



CÓDIGO	MEDIDA	€/100	
FICAPD160	80 (x2)	113,333	50

FI-CA CL

Clip



CÓDIGO	MEDIDA	€/100	TALADRO	
FICAACL13	Ø13	16,333	Ø6	200
FICAACL26	Ø16	21,667	Ø6	100



CÓDIGO	MEDIDA	€/100	VÁLIDO PARA	UD. MIN. VENTA	
GRBL001	2 x 0,7	6,390	Cable Paralelo	400	100
GRBL002	2 x 0,4 - 0,7 ó 1	6,740	Cable Paralelo	400	100
GRBL003	2 x 1 - 3 x 0,7	6,820	Cable Plano 6 x 2	400	100
GRBL010	2 x 0,7 - 2 x 1	8,117	Cable Plano 6 x 3	400	100
GRBL020	2 x 1,5 - 3 x 1	8,243	Cable Plano 7,5 x 3,5	400	100
GRBL030	3 x 1,5 - 3 x 2,5	9,973	Cable Plano 10 x 3,5	400	100
GRBL040	1 x 1 - 2 x 0,5	7,860	Cable Redondo Ø4	400	100
GRBL050	2 x 0,75	8,073	Cable Redondo Ø5	400	100
GRBL060	2 x 1	8,550	Cable Redondo Ø6	400	100
GRBL070	2 x 1-1,5	9,327	Cable Redondo Ø7	400	100
GRBL080	2 x 2,5	9,410	Cable Redondo Ø8	400	100
GRBL090	3 x 2,5	10,363	Cable Redondo Ø9	400	100
GRBL100	2 x 4	11,570	Cable redondo Ø10	200	100
GRBL120	3 x 6	14,207	Cable redondo Ø12	200	100
GRBL140	4 x 6	16,877	Cable Redondo Ø14	200	100



Blister

CÓDIGO	MEDIDA	€/BOLSA	PCS. 	BOLSAS
BZGRB100	2 x 4	2,565	6	20
BZGRB010	2 x 1	2,565	6	20
BZGRB120	3 x 6	2,565	6	15
BZGRB001	2 x 0,7	2,565	6	20
BZGRB050	2 x 0,75	2,565	6	20
BZGRB060	2 x 1	2,565	6	20
BZGRB070	2 x 1-1,5	2,565	6	20
BZGRB080	2 x 2,5	2,565	6	20
BZGRB090	3 x 2,5	2,565	6	20



CÓDIGO	MEDIDA	€/100	VÁLIDO PARA	UD. MIN. VENTA	
GRNE060	2 x 1	8,550	Cable Redondo	400	100
GRNE070	2 x 1 - 2 x 1,5	9,327	Cable Redondo	400	100
GRNE080	2 x 2,50	9,410	Cable Redondo	400	100
GRNE090	3 x 2,50	10,363	Cable Redondo	400	100
GRNE100	2 x 4	11,570	Cable Redondo	200	100
GRNE120	3 x 6	14,207	Cable Redondo	200	100



CÓDIGO	MEDIDA	€/100	VÁLIDO PARA	UD. MIN. VENTA		
GRNATTV	GRAPILLA - CLIP - CRAMPON TV - CLIP	11,160	Cable Redondo	200	100	2.000

GR-NY BL

Grapilla de nylon con clavo de acero cincado. Blanca



GR-NY N

Grapilla de nylon con clavo de acero cincado. Negra



GR-NY NT

Grapilla de nylon con clavo de acero cincado. Natural





PERFILERÍA Y SOPORTACIÓN





PUENTES GUÍA	TORNILLOS GUÍA	TUERCAS GUÍA	TAPONES
GZ2718 PGZ2830 PGZ3840 PGI2718 PGI2830 PGI3840 PGX4121 PGX4141	TC230620 TC230820 TC230830 TC340830 TC341030 TCR230620 TCR230820 TCR230830 TCR340830 TCR341030 TCRX0830 TCRX0860 TCRX1030 TCRX1060	TUG201006 TUG201008 TUG271808 TUG271810 TUGRA2706 TUGRA2708 TUGRA3808 TUGRA3810 TUCX08 TUCX10 TUCXMU08 TUCXMU10 TURX08 TURX10 TURX12 TURXA08 TURXA10	SOTP2718 SOTP2830 SOTP3840 SOTP4121 SOTP4141
	M6 x 20 M8 x 20 M8 x 30 M8 x 30 M10 x 30 M6 x 20 M8 x 20 M8 x 30 M8 x 30 M10 x 30 M8 x 30 M8 x 60 M10 x 30 M10 x 60	M6 M8 M8 M10 M6 M8 M8 M10 M8 M10 Muelle Muelle	

GP

Perfiles para cargas ligeras tipo "C"

GP-Z

Guía perforada cincada



METAL



CÓDIGO	MEDIDA	€/100	LONGITUD	
GPZ201010	20 x 10 x 1 x 2.000	872,193	2.000	30
GPZ250808	25 x 8 x 0,80 x 1.000	604,403	1.000	30

GP-G

Guía perforada ATLANTIS C2-H



METAL



CÓDIGO	MEDIDA	€/100	LONGITUD	
GPG271812	27 x 18 x 1,25 x 2.000	1.478,793	2.000	10
GPG283018	28 x 30 x 1,8 x 2.000	2.967,427	2.000	10
GPG351312	35 x 13 x 1,2 x 2.000	2.923,683	2.000	10
GPG384020	38 x 40 x 2 x 2.000	5.041,500	2.000	6
GPG402015	40 x 20 x 1,50 x 2.000	2.302,116	2.000	10

GP-A2

Guía perforada inoxidable A2



INOXIDABLE



CÓDIGO	MEDIDA	€/100	LONGITUD	
GPI271812	27 x 18 x 1,25 x 2.000	12.032,189	2.000	6
GPI283015	28 x 30 x 1,50 x 2.000	27.975,448	2.000	6

GP-PL

Guía perforada plastificada amarilla



METAL



CÓDIGO	MEDIDA	€/100	LONGITUD	
GPP271812	27 x 18 x 1,25	2.069,667	1.000	10

GP-PVC

Guía perforada PVC



METAL



CÓDIGO	MEDIDA	€/100	LONGITUD	
GPV251120	25 x 11 x 2 x 1.000	843,660	1.000	30



Perfiles para cargas ligeras tipo "C"

GP

METAL



CÓDIGO	MEDIDA	€/100	LONGITUD	
GL0357510	35x7,5x1,0	1.248,443	2.000	10
GL0351515	35x15x1,5	1.655,013	2.000	10

GL-O

Guía Omega lisa ATLANTIS C2-M



METAL



CÓDIGO	MEDIDA	€/100	LONGITUD	
GP0357510	35x7,5x1,0	1.258,747	2.000	10
GP0351515	35x15x1,5	1.649,893	2.000	10

GP-O

Guía Omega perforada ATLANTIS
C2-M



Soportes para cargas ligeras tipo "C"

SP

METAL



CÓDIGO	MEDIDA	€/100	LONGITUD	
SPZ271820	27 x 18 x 1,25 x 200	776,810	200	10
SPZ271830	27 x 18 x 1,25 x 300	838,267	300	10
SPZ384020	38 x 40 x 2 x 200	1.270,253	200	10
SPZ384025	38 x 40 x 2 x 250	1.425,973	250	10
SPZ384030	38 x 40 x 2 x 300	1.567,947	300	10
SPZ384035	38 x 40 x 2 x 350	1.679,877	350	10
SPZ384040	38 x 40 x 2 x 400	1.957,943	400	10
SPZ384050	38 x 40 x 2 x 500	2.377,794	500	10
SPZ384060	38 x 40 x 2 x 600	2.647,880	600	10

SP-Z

Soporte perforado cincado



METAL



CÓDIGO	MEDIDA	€/100	VÁLIDO PARA	
SPV2718	M10 (27/18-28/30)	556,423	27/18 - 28/30	50
SPV3840	M10 (38/40-40/20)	591,583	38/40 - 40/20	50

SP-V

Soporte vertical



SP

Soportes para cargas ligeras tipo "C"

SP-H

Soporte horizontal



METAL



CÓDIGO	MEDIDA	€/100	VÁLIDO PARA	
SPH2718	M10 (27/18-28/30)	497,013	27/18 - 28/30	50
SPH3840	M10 (38/40-40/20)	515,487	38/40 - 40/20	50

SP-HX

Soporte horizontal carriles



METAL



CÓDIGO	MEDIDA	€/100	VÁLIDO PARA	
SPGH2718	M10 (27/18-28/30)	780,340	27/18 - 28/30	10
SPGH3840	M10 (38/40-40/20-41/21-41/41)	1.516,640	38/40 - 40/20 - 41/21 - 41/41	10

PE-AC

Accesorios para perfiles tipo "C"

TO-GU

Tope tornillo guía



METAL



CÓDIGO	MEDIDA	€/100	VÁLIDO PARA		
TG230620	M6 x 20	66,583	20/10 - 27/18 - 28/30 - 25/08 - 25/11	100	800
TG230820	M8 x 20	82,883	27/18 - 28/30 - 25/08	100	400
TG230830	M8 x 30	87,237	27/18 - 28/30 - 25/08	100	600
TG340830	M8 x 30	120,040	38/40 - 40/20	100	600
TG341030	M10 x 30	161,920	38/40 - 40/21	100	400

TO-GR

Tope tornillo guía de fijación rápida



METAL



CÓDIGO	MEDIDA	€/100	VÁLIDO PARA		
TGR230620	M6x20	184,313	20/10 - 25/08 - 25/11 - 27/18 - 28/30	100	600
TGR230820	M8x20	194,827	20/10 - 25/08 - 25/11 - 27/18 - 28/30	100	600
TGR230830	M8x30	199,467	20/10 - 25/08 - 25/11 - 27/18 - 28/30	100	600
TGR340830	M8x30	250,530	27/18 - 28/30 - 38/40 - 40/20	100	400
TGR341030	M10x30	282,887	27/18 - 28/30 - 38/40 - 40/20	50	300

TU-GU

Tuerca guía perforada



METAL



CÓDIGO	MEDIDA	€/100	VÁLIDO PARA		
TUG201006	M6	17,963	20/10 - 25/08 - 27/18 - 28/30	100	3.000
TUG201008	M8	17,963	20/10 - 25/08 - 27/18 - 28/30	100	2.400
TUG271808	M8	48,370	27/18 - 28/30 - 38/40 - 40/20	100	1.200
TUG271810	M10	48,370	27/18 - 28/30 - 38/40 - 40/20	100	1.200

METAL



CÓDIGO	MEDIDA	€/100	VÁLIDO PARA		
TUGRA2706	M6	165,203	20/10 - 25/08 - 25/11 - 27/18 - 28/30	50	600
TUGRA2708	M8	165,203	20/10 - 25/08 - 25/11 - 27/18 - 28/30	50	600
TUGRA3808	M8	211,863	27/18 - 28/30 - 38/40 - 40/20	50	600
TUGRA3810	M10	225,540	27/18 - 28/30 - 38/40 - 40/20	50	600

TU-GRA

Tuerca guía con arandela de fijación rápida



METAL



CÓDIGO	MEDIDA	€/100	VÁLIDO PARA		
EMZ45	50 x 50 45°	126,340	25/11 - 27/18 - 28/30 - 38/40 - 40/20 - 41/21 - 41/41	100	400
EMZ90	54 x 54 90°	126,340	25/11 - 27/18 - 28/30 - 38/40 - 40/20 - 41/21 - 41/41	100	300
EMZ00	100 180°	123,183	25/11 - 27/18 - 28/30 - 38/40 - 40/20 - 41/21 - 41/41	100	-

EG-Z

Escuadra cincada



INOXIDABLE



CÓDIGO	MEDIDA	€/100	VÁLIDO PARA		
EMI45	50 x 50 45°	617,260	27/18 - 28/30 - 38/40	50	200
EMI90	54 x 54 90°	617,260	27/18 - 28/30 - 38/40	50	-
EMIO0	100 180°	611,967	27/18 - 28/30 - 38/40	50	200

EG-A2

Escuadra inoxidable A2



METAL



CÓDIGO	MEDIDA	€/100	VÁLIDO PARA	
PUZ2718	M8 (27/18-28/30)	56,987	50	-
PUZ3840	M8 (38/40)	63,023	50	-

PU-Z

Placa de unión para perfiles



METAL



CÓDIGO	MEDIDA	€/100	VÁLIDO PARA		
PGZ2718	27 / 18 x 81	106,597	27/18	50	300
PGZ2830	28 / 30 x 81	129,097	28/30	50	300
PGZ3840	38 / 40 x 93	144,030	38/40	50	100

PG-Z

Puente guía cincado



INOXIDABLE



CÓDIGO	MEDIDA	€/100	VÁLIDO PARA		
PGI2718	27 / 18 x 81	301,077	27/18	50	300
PGI2830	28 / 30 x 81	346,240	28/30	50	200
PGI3840	38 / 40 x 93	421,507	38/40	50	100

PG-A2

Puente guía inoxidable A2



PE-AC

Accesorios para perfiles tipo "C"

SO-TP

Tapones plásticos



METAL



CÓDIGO	MEDIDA	€/100	VÁLIDO PARA		
SOTP2718	27/18	31,497	27/18	100	400
SOTP2830	28/30	37,880	28/30	100	300
SOTP3840	38/40	61,410	38/40	100	300

GPX

Perfiles para cargas pesadas Indextrut

GP-X 21

Guía perforada Indextrut 41x21



METAL



CÓDIGO	MEDIDA	€/100	LONGITUD	
GPX412115	41 x 21 x 1,5	5.172,350	3.000	10
GPX412120	41 x 21 x 2	5.550,103	3.000	10
GPX412125	41 x 21 x 2,5	7.970,713	3.000	6
GPX2M412120	41 x 21 x 2	3.881,187	2.000	10

GP-X 41

Guía perforada Indextrut 41x41



METAL



CÓDIGO	MEDIDA	€/100	LONGITUD	
GPX414115	41 x 41 x 1,5	6.278,517	3.000	10
GPX414120	41 x 41 x 2	9.120,367	3.000	6
GPX414125	41 x 41 x 2,5	11.254,700	3.000	6
GPX2M414120	41 x 41 x 2	6.146,427	2.000	10

SPX

Soportes para cargas pesadas Indextrut

SP-X

Soporte perforado Indextrut



METAL



CÓDIGO	MEDIDA	€/100	LONGITUD	
SPX412115	41 x 21 x 2,5 x 150	1.123,907	150	10
SPX412130	41 x 21 x 2,5 x 300	1.547,242	300	10
SPX412145	41 x 21 x 2,5 x 450	1.964,934	450	10
SPX414115	41 x 41 x 2,5 x 150	1.456,371	150	10
SPX414130	41 x 41 x 2,5 x 300	2.040,254	300	10
SPX414145	41 x 41 x 2,5 x 450	2.667,989	450	10
SPX414160	41 x 41 x 2,5 x 600	3.354,439	600	10
SPX414175	41 x 41 x 2,5 x 750	4.044,979	750	10
SPX414110	41 x 41 x 2,5 x 1.000	5.086,880	1.000	2

SP-RX

Soporte base rectangular "U" Indextrut



METAL



CÓDIGO	MEDIDA	€/100	VÁLIDO PARA	
SPRXH4121	M12 (41/21-41/41)	1.492,127	Indextrut 41/41 - 41/21	12
SPRXV4121	M12 (41/21-41/41)	1.492,127	Indextrut 41/41 - 41/21	12



Soportes para cargas pesadas Indextrut

SPX

METAL



CÓDIGO	MEDIDA	€/100	VÁLIDO PARA	
SPUX412100	M16 (41/21-41/41)	1.896,047	Indextrut 41/41 - 41/21	12
SPUX412145	M16 (41/21-41/41)	1.896,047	Indextrut 41/41 - 41/21	12

SP-UX

Soporte base cuadrada "U" Indextrut



METAL



CÓDIGO	VÁLIDO PARA	€/100	
PRX01	Indextrut 41/41 - 41/21	1.647,360	12

PR-X

Soporte regulable Indextrut



METAL



CÓDIGO	MEDIDA	€/100	VÁLIDO PARA	
RESX300	252 x 252 x 6 (300)	1.250,963	10	20
RESX550	428 x 428 x 6 (550)	1.992,833	10	20

RE-SX

Refuerzo para soportes Indextrut



Accesorios para perfiles Indextrut

PX-AC

METAL



CÓDIGO	MEDIDA	€/100	VÁLIDO PARA		
TGX0840	M8 x 40	119,690	Indextrut 41/41 - 41/21	100	400
TGX0860	M8 x 60	128,283	Indextrut 41/41 - 41/21	50	300
TGX1040	M10 x 40	152,987	Indextrut 41/41 - 41/21	50	300
TGX1060	M10 x 60	171,597	Indextrut 41/41 - 41/21	50	200

TG-X

Tope tornillo Guía Indextrut



METAL



CÓDIGO	MEDIDA	€/100	VÁLIDO PARA	
TGRX0830	M8x30	280,567	41/41 - 41/21	100
TGRX0860	M8x60	293,400	41/41 - 41/21	50
TGRX1030	M10x30	318,930	41/41 - 41/21	50
TGRX1060	M10x60	338,590	41/41 - 41/21	50

TO-GRX

Tope tornillo Guía de fijación rápida Indextrut



METAL



CÓDIGO	MEDIDA	€/100	VÁLIDO PARA		
TUGX08	M8	73,290	Indextrut 41/41 - 41/21	100	800
TUGX10	M10	81,040	Indextrut 41/41 - 41/21	100	800

TU-GX

Tuerca guía Indextrut



PX-AC

Accesorios para perfiles Indextrut

TU-MU

Tuerca guía Indextrut con muelle



METAL



CÓDIGO	MEDIDA	€/100	VÁLIDO PARA		
TUGXMU08	M8	107,097	Indextrut 41/41	100	400
TUGXMU10	M10	107,097	Indextrut 41/41	100	400

TU-RX

Tuerca guía de fijación Rápida Indextrut



METAL



CÓDIGO	MEDIDA	€/100	VÁLIDO PARA		
TURX08	M8	101,450	Indextrut 41/41 - 41/21	100	400
TURX10	M10	115,903	Indextrut 41/41 - 41/21	100	400
TURX12	M12	128,530	Indextrut 41/41 - 41/21	50	300

NEW TU-RX A2

Tuerca rápida INDEXTRUT. Inoxidable A2



METAL



CÓDIGO	MEDIDA	€/100		
TURXA208	M8	151,443	50	300

TU-RXA

Tuerca guía con arandela de fijación rápida Indextrut



METAL



CÓDIGO	MEDIDA	€/100	VÁLIDO PARA		
TURXA08	M8	244,850	41/21 - 41/41	50	50
TURXA10	M10	267,643	41/21 - 41/41	50	50

EG-X

Escuadra para Indextrut



METAL



CÓDIGO	MEDIDA	€/100	N° AGUJEROS	VÁLIDO PARA		
EMX4502	86/52 x 40 x 5 45°	289,167	2	Indextrut 41/41 - 41/21	25	125
EMX9002	48 x 51 x 5 90°	188,893	2	Indextrut 41/41 - 41/21	50	150
EMX1302	71/48 x 40 x 5 135°	307,823	2	Indextrut 41/41 - 41/21	20	100
EMX9004	95 x 98 x 5 90°	298,497	4	Indextrut 41/41 - 41/21	25	75

SC-RX

Escuadra reforzada Indextrut



METAL



CÓDIGO	MEDIDA	€/100	VÁLIDO PARA	
SCRX090	100 x 100 x 40	737,497	Indextrut 41/41 - 41/21	10

METAL



CÓDIGO	VÁLIDO PARA	€/100	
EMPX4121	Indextrut 41/41 - 41/21	1.156,673	10

EMP-X

Empalme Indextrut



METAL



CÓDIGO	VÁLIDO PARA	€/100	
RTX01	41/41 - 41/21 - 41/62	886,247	10

RT-X

Soporte Rótula Indextrut



METAL



CÓDIGO	N° AGUJEROS	€/100	VÁLIDO PARA		
UNPX412101	1	78,317	41/41 - 41/21	50	300
UNPX412102	2	161,687	41/41 - 41/21	25	150
UNPX412103	3	227,370	41/41 - 41/21	25	125
UNPX412104	4	282,950	41/41 - 41/21	10	60

UN-PX

Placa de unión Indextrut



METAL



CÓDIGO	N° AGUJEROS	€/100	VÁLIDO PARA	
UNEX412103	3	411,773	41/41 - 41/21	25

UN-EX

Placa de unión Escuadra Indextrut



METAL



CÓDIGO	N° AGUJEROS	€/100	VÁLIDO PARA	
UNTX412104	4	303,160	41/41 - 41/21 - 41/62	25

UN-TX

Placa de unión "T" Indextrut



METAL



CÓDIGO	N° AGUJEROS	€/100	VÁLIDO PARA		
PGX4121	3	380,193	Indextrut 41/21	15	90
PGX4141	5	503,910	Indextrut 41/41	10	60

PG-X

Puente guía Indextrut



PX-AC

Accesorios para perfiles Indextrut

AB-GX

Abrazadera para guía perforada
Indextrut



METAL



CÓDIGO	€/100	VÁLIDO PARA	
ABGX4121	589,183	Indextrut 41/41 - 41/21	20

SO-TP

Tapones plásticos para soportación



METAL



CÓDIGO	MEDIDA	€/100	VÁLIDO PARA		
SOTP4121	41/21	50,470	41/21	100	600
SOTP4141	41/41	52,917	41/41	100	300

VE-AC

Accesorios de ventilación

UN-CO

Unión conducto tipo "C"



METAL



CÓDIGO	MEDIDA	€/100		
UNCO3220	32 x 20	58,917	100	400

SO-PG

Perfil de goma isofónico para
soportación



METAL



CÓDIGO	MEDIDA	€/1PC	VÁLIDO PARA	LONGITUD	
SOPG27	27	138,805	27/18 - 28/30	20 m.	1
SOPG38	38	198,066	38/40 - 40/20	20 m.	1
SOPG41	41	202,631	41/21 - 41/41	20 m.	1



SISTEMAS DE INSTALACIÓN Y FIJACIONES PARA PANELES FOTOVOLTAICOS



NEW

ISF-GG

Grapas y galgas para montaje de placas

KFR-SC

Grapa fijación rápida



METAL



CÓDIGO	MEDIDA	€/100		
KFRSC3050	30 - 50	653,930	10	240

PGS-A

Perfil grapa



METAL



CÓDIGO	MEDIDA	€/100		
PGSA26	26	103,450	20	720

GM-A

Galga de aluminio para marco



METAL



CÓDIGO	MEDIDA	€/100		
GMA035	35	180,180	10	120
GMA040	40	198,473	10	120

NEW

ISF-PU

Perfiles, uniones, guías y empalmes para estructura de apoyo

GP-XS

Guía perforada INDEXTRUT solar. Atlantis C4-M



METAL



CÓDIGO	MEDIDA	€/100	
GPXS4115012	41 x 41 x 1,5 - L.125	433,173	50
GPXS4115162	41 x 41 x 1,5 - L.1.625	3.098,237	10
GPXS4115212	41 x 41 x 1,5 - L.2.125	3.985,367	10
GPXS4115325	41 x 41 x 1,5 - L.3.250	6.095,663	6

EMP-XS

Empalme INDEXTRUT solar. Atlantis C4-M



METAL



CÓDIGO	MEDIDA	LONGITUD	€/100	
EMPXS4115	41 x 41 x 1,5	120	524,383	40

METAL



CÓDIGO	MEDIDA	€/100	
PSAA0400	80 x 35 - L.400	1.142,517	20
PSAA2125	80 x 35 - L.2.125	5.336,223	2
PSAA3150	80 x 35 - L.3.150	7.795,997	2

PSA-A

Perfil de aluminio con alas



METAL



CÓDIGO	MEDIDA	€/100	
PSAAV0150	41 x 33 x 1,8	897,940	20

PSA-AV

Perfil solar de aluminio con alas para fijación directa en valle



METAL



CÓDIGO	MEDIDA	VÁLIDO PARA	€/100	
PSAUN200	200	PSA-UN	383,080	20

PSA-UN

Unión de perfil de aluminio con alas



METAL



CÓDIGO	MEDIDA	€/100	
PSEA601575	47 x 60 - L.1.575	4.836,207	2
PSEA602125	47 x 60 - L.2.125	6.498,457	2
PSEA603150	47 x 60 - L.3.150	9.521,867	2

PSE-A

Perfil de aluminio para fijación ensamblada



METAL



CÓDIGO	MEDIDA	VÁLDO PARA	€/100	
PSEUN060200	60 x 200	PSE-A	533,173	20

PSE-UN

Unión de perfil de aluminio para fijación ensamblada

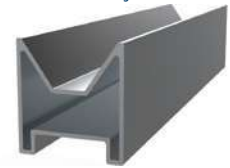

NEW

ISF-CC

Conectores + Complementos para montaje de estructuras solares

KFS-FI

Conector cruzado para fijación inferior. Inoxidable A2



METAL



CÓDIGO	MEDIDA	€/100		
KFSFIM08	M8	163,187	100	

KFS-FL

Conector cruzado para fijación lateral. Tornillo Inoxidable A2



METAL



CÓDIGO	MEDIDA	€/100		
KFSFLM08	M8	339,487	10	80

TU-RX A2

Tuerca rápida INDEXTRUT. Inoxidable A2



METAL



CÓDIGO	MEDIDA	€/100		
TURXA208	M8	151,443	50	300

DIN-603 A2

Tornillo DIN-603. Cabeza redonda y cuello cuadrado. Inoxidable A2



METAL



CÓDIGO	MEDIDA	€/100		
D603I08016	M8 x 16	42,047	200	2.400

DIN-6921 A2

Tornillo DIN-6921. Tornillo hexagonal con arandela estampada y grafilada. Inoxidable A2



METAL



CÓDIGO	MEDIDA	€/100	LLAVE DE INSTALACIÓN		
6921I08020	M8 x 20	46,040	13	200	2.400
6921I08050	M8 x 50	87,807	13	100	600
6921I08070	M8 x 70	112,967	13	100	600

DIN-6923 A2

Tuerca brida grafilada DIN-6923. Inoxidable A2



METAL



CÓDIGO	MEDIDA	€/100	LLAVE DE INSTALACIÓN		
D6923IM08	M8	22,833	13	250	3.000
D6923IM10	M10	38,510	15	250	3.000
D6923IM12	M12	65,500	18	250	1.500

Conectores + Complementos para montaje de
estructuras solares

ISF-CC NEW

METAL



CÓDIGO	MEDIDA	€/100		
D127IM08	M8	4,530	200	9.000
D127IM10	M10	7,237	100	4.500
D127IM12	M12	10,923	100	4.500

DIN-127 A2

Arandela muelle grower DIN-127.
Inoxidable A2



Triángulos para instalación de placas solares

ISF-TR NEW

METAL



CÓDIGO	MEDIDA	VÁLIDO PARA	€/PC	
TPAR251500	25°/30°/35° - L.1.500	PSE-A	78,383	4

TPA-R

Triángulo regulable de aluminio
premontado



METAL



CÓDIGO	MEDIDA	e (mm)	€/100	
TPAP352000	35 x 35 - L.2.000	2	2.107,607	2

TPA-P

Perfil riostra para triángulo de
aluminio premontado



METAL



CÓDIGO	MEDIDA	VÁLIDO PARA	€/PC	
TRPX5412515	25°-35° - L.1.500	GP-XS	76,967	4

TRP-XS

Triángulo regulable premontado
INDEXTRUT. Acero con recubrimiento
Atlantis C4-M



METAL



CÓDIGO	MEDIDA	VÁLIDO PARA	€/100		
NUXSM0841	M8	GP-XS	706,420	10	100

NU-XS

Nudo articulado INDEXTRUT. Acero
con recubrimiento Atlantis C4-M



NEW

ISF-FR

Accesorios regulables para la instalación de placas solares

GS-TC

Gancho salvateja ajustable para teja curva. Inoxidable A2



METAL



CÓDIGO	MEDIDA	€/100		
GSTC040080	40 - 80	2.603,363		20
GSTC080120	80 - 120	2.662,000		20

GS-TU

Gancho salvateja ajustable para teja universal. Inoxidable A2



METAL



CÓDIGO	MEDIDA	€/100		
GSTU040055	40 - 55	2.703,960		20

STR

Soporte regulable para perfil trapezoidal. Inoxidable A2



METAL



CÓDIGO	MEDIDA	€/100		
STR1680	16 - 80	1.763,737		40

KFS-MA

Kit tornillo doble rosca. Inoxidable A2



METAL



CÓDIGO	MEDIDA	€/100	LLAVE DE INSTALACIÓN		
KFSMA10200	10 x 200	555,310	7	25	150
KFSMA10250	10 x 250	620,117	7	25	150

KFS-AU

Kit tornillo autorroscante. Inoxidable A2



METAL



CÓDIGO	MEDIDA	€/100	LLAVE DE INSTALACIÓN		
KFSAU10160	10 x 160	1.680,417	13		25
KFSAU10200	10 x 200	2.028,090	13		25

Accesorios regulables para la instalación de placas solares

ISF-FR **NEW**





CÓDIGO	MEDIDA	€/100	LLAVE DE INSTALACIÓN		
KFSRV10250	10 x 250	613,933	7	25	150
KFSRV12350	12 x 350	1.080,440	9	25	75

KFS-RV

Kit varilla roscada para instalación con anclaje químico. Inoxidable A2



CÓDIGO	MEDIDA	€/100		
PMO1012	M10 -M12	248,343	25	300

PMO



Placa para tornillo doble rosca. Inoxidable A2



Accesorios de fijación directa para la instalación de placas solares

ISF-FD **NEW**



CÓDIGO	MEDIDA	€/100			
TACN165525	5,5 x 25 P16	41,087	8	500	2.000

TAC + ARVUL A2

Tornillo de cosido Atlantis C4-M + Arandela vulcanizada EPDM-inoxidable A2





CÓDIGO	MEDIDA	€/100			
TACB166025	6 x 25 P16	99,783	8	500	2.000

TAC BIMETAL+ARVUL A2

Tornillo de cosido Bimetal + Arandela vulcanizada EPDM-inoxidable A2



CÓDIGO	MEDIDA	€/100	Ø BROCA		
RETE5220	5,2 x 20	90,753	5,3	250	3.000

RE-TE

Remache trebol estanco + Arandela vulcanizada EPDM



NEW

ISF-ES

Accesorios de estanqueidad para la instalación de placas solares

ARS-P

Arandela paraguas inoxidable A2 + EPDM



METAL



CÓDIGO	MEDIDA	€/100		
ARSP08	M8	31,440	100	1.200
ARSP10	M10	31,440	100	1.200

ARS-S

Arandela para tornillo doble rosca



METAL



CÓDIGO	MEDIDA	€/100		
ARSS10	M10	21,613	100	1.200
ARSS12	M12	21,613	100	1.200

CS-B

Cinta de estanqueidad de butileno



METAL

CÓDIGO	MEDIDA	€/PC		
CSB0104010	40 x 1 - L.10	18,413	1	27
CSB0108010	80 x 1 - L.10	35,983	1	18

NEW

ISF-KT

Kits para instalaciones solares

KC-PSA

Coplanar con perfil con alas de aluminio (PSA-A). Fijación directa



METAL

CÓDIGO	MEDIDA	€/PC	
KCPSA0235	x2 (35 mm)	187,973	1
KCPSA0240	x2 (40 mm)	188,817	1
KCPSA0335	x3 (35 mm)	270,703	1
KCPSA0340	x3 (40 mm)	271,547	1

KC-PSD

Coplanar con perfil con alas de aluminio (PSA-A). Fijación directa formato de perfil discontinuo



METAL

CÓDIGO	MEDIDA	€/PC	
KCPSD0100	+1 (30-50)	45,597	1
KCPSD0135	x1 (35 mm)	95,203	1
KCPSD0140	x1 (40 mm)	96,047	1

Kits para instalaciones solares

ISF-KT **NEW**

METAL

CÓDIGO	MEDIDA	€/PC	
KCPSE0235	x2 (35 mm)	225,967	1
KCPSE0240	x2 (40 mm)	226,807	1
KCPSE0335	x3 (35 mm)	332,327	1
KCPSE0340	x3 (40 mm)	333,170	1

KC-PSE

Coplanar con perfil de aluminio PSE-A.
Fijación ensamblada



METAL

CÓDIGO	MEDIDA	€/PC	
KCGPX0235	x2 (35 mm)	156,907	1
KCGPX0240	x2 (40 mm)	157,747	1
KCGPX0335	x3 (35 mm)	238,543	1
KCGPX0340	x3 (40 mm)	239,383	1

KC-GPX

Coplanar con guía perforada acero
Atlantis C4-M INDEXTRUT SOLAR
GP-XS



METAL

CÓDIGO	MEDIDA	€/PC	
KCGPD0100	+1 (30-50)	28,007	1
KCGPD0135	x1 (35 mm)	61,297	1
KCGPD0140	x1 (40 mm)	62,140	1

KC-GPD

Coplanar con guía perforada Atlantis
C4-M INDEXTRUT SOLAR GP-XS.
Formato guía discontinua



METAL

CÓDIGO	MEDIDA	€/PC	
KTPSE0235	x2 (35 mm)	426,220	1
KTPSE0240	x2 (40 mm)	427,060	1
KTPSE0335	x3 (35 mm)	634,583	1
KTPSE0340	x3 (40 mm)	635,423	1

KT-PSE

Triangular con perfil de aluminio
PSE-A. Fijación ensamblada



METAL

CÓDIGO	MEDIDA	€/PC	
KTGPX0235	x2 (35 mm)	343,013	1
KTGPX0240	x2 (40 mm)	343,853	1
KTGPX0335	x3 (35 mm)	517,703	1
KTGPX0340	x3 (40 mm)	518,547	1

KT-GPX

Triangular con guía perforada Atlantis
C4-M INDEXTRUT SOLAR GP-XS





SISTEMAS DE FIJACIÓN RÁPIDA EN VIGA



SU

Sistemas de fijación rápida en viga

SU-MO

Mordaza para viga



02 Info Técnica P. 410



CÓDIGO	MEDIDA	€/100	ANCHO MÁX. ALA VIGA		
SUMOP09	PASANTE Ø9	386,520	20	50	150
SUMOP11	PASANTE Ø11	424,970	20	50	150
SUMOP13	PASANTE Ø13	646,837	25	50	100
SUMOM06	ROSCADO M6	331,673	20	50	200
SUMOM08	ROSCADO M8	386,520	20	50	200
SUMOM10	ROSCADO M10	424,970	20	50	150
SUMOM12	ROSCADO M12	646,837	25	50	-

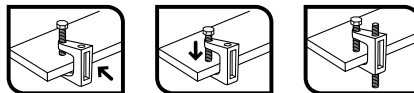

SU-CL

Clip de suspensión



02 Info Técnica P. 410



CÓDIGO	MEDIDA	€/100	LONGITUD MIN. ALA VIGA	ESPEJOR VIGA		
SUCL02	6.3	38,117	14	1,5 - 4	100	1.200
SUCL04	6.3	54,520	23	4 - 10	100	400
SUCL10	6.3	63,497	23	10 - 15	100	300
SUCL15	6.3	84,660	23	15 - 20	100	300

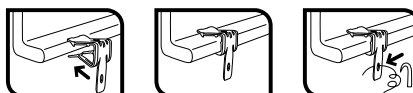

SU-VA

Clip varilla



02 Info Técnica P. 411



CÓDIGO	MEDIDA	€/100	LONGITUD MIN. ALA VIGA	ESPEJOR VIGA		
SUVA0602	M6	97,870	14	1,5 - 4	100	300
SUVA0604	M6	119,217	23	4 - 10	100	200
SUVA0610	M6	175,370	23	10 - 15	100	-
SUVA0615	M6	211,657	23	15 - 20	100	-
SUVA0804	M8	119,217	23	4 - 10	100	200
SUVA0810	M8	175,370	23	10 - 15	100	200
SUVA0815	M8	211,657	23	15 - 20	100	-
SUVA0802	M8	97,870	14	1,5 - 4	100	300

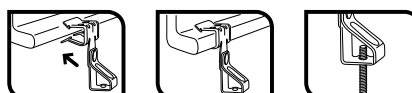

Sistemas de fijación rápida en viga

SU



CÓDIGO	MEDIDA	€/100	ESPESOR VIGA		
SUCU0602	M6	98,303	1,5 - 5	100	300
SUCU0605	M6	109,257	5 - 7	100	300
SUCU0606	M6	136,773	3 - 7	100	200
SUCU0607	M6	161,213	7 - 10	100	200

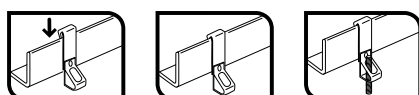

SU-CU

Clip de cuelgue



 02
 P. 411
 Info.
 Técnica

CÓDIGO	MEDIDA	€/100	ESPESOR MÁX. A FIJAR	ANCHO MÁX. DE VIGA	MEDIDA TORNILLO		
SUAB0603	M6	92,911	3 - 7	36,5	M6x9	100	300
SUAB0607	M6	93,281	7 - 13	36,5	M6x9	100	200
SUAB0614	M6	97,185	14 - 20	36,5	M6x9	100	200

SU-AB **NEW**

Clip de viga para abrazadera



 02
 P. 411
 Info.
 Técnica

CÓDIGO	MEDIDA	€/100	ESPESOR MÁX. A FIJAR		
SUCA0602	6-7	32,125	1 - 4	100	2.400
SUCA0604	6-7	32,867	4 - 7,5	100	1.200
SUCA0607	6-7	33,375	7,5 - 12	100	1.200
SUCA0802	8-9	33,483	1 - 4	100	1.200
SUCA0804	8-9	34,000	4 - 7,5	100	1.200
SUCA0807	8-9	34,425	7,5 - 12	100	1.200
SUCA1002	10-11	34,158	1 - 4	100	1.200
SUCA1004	10-11	34,683	4 - 7,5	100	1.200
SUCA1007	10-11	35,142	7,5 - 12	100	1.200
SUCA1202	12-14	34,967	1 - 4	100	1.200
SUCA1204	12-14	35,475	4 - 7,5	100	1.200
SUCA1207	12-14	35,608	7,5 - 12	100	1.200
SUCA1502	15-18	35,725	1 - 4	100	1.200
SUCA1504	15-18	36,492	4 - 7,5	100	1.200
SUCA1507	15-18	36,642	7,5 - 12	100	1.200
SUCA1902	19-24	36,558	1 - 4	100	1.200
SUCA1904	19-24	44,300	4 - 7,5	100	600
SUCA1907	19-24	45,158	7,5 - 12	100	600
SUCA2502	25-30	45,533	1 - 4	100	600
SUCA2504	25-30	50,792	4 - 7,5	100	600
SUCA2507	25-30	55,617	7,5 - 12	100	600

SU-CA **NEW**

Clip de viga para cable



 02
 P. 411
 Info.
 Técnica



VARILLA ROSCADA Y ACCESORIOS DE FIJACIÓN



RV

Varilla roscada

RV-ZN

Cincada. 1 metro



METAL



CÓDIGO	MEDIDA	€/100	PASO	
975ZM04	M4 x 1.000	115,343	0,7	100
975ZM05	M5 x 1.000	153,790	0,8	100
975ZM06	M6 x 1.000	150,373	1	100
975ZM08	M8 x 1.000	262,817	1,25	50
975ZM10	M10 x 1.000	396,090	1,5	25
975ZM12	M12 x 1.000	615,293	1,75	20
975ZM14	M14 x 1.000	845,333	2	10
975ZM16	M16 x 1.000	1.082,177	2	10
975ZM18	M18 x 1.000	1.518,877	2,5	10
975ZM20	M20 x 1.000	1.929,363	2,5	5
975ZM22	M22 x 1.000	2.605,157	2,5	5
975ZM24	M24 x 1.000	2.751,817	3	5
975ZM27	M27 x 1.000	3.178,493	3	5
975ZM30	M30 x 1.000	4.200,437	3,5	5
975ZM33	M33 x 1.000	5.168,790	3,5	3
975ZM36	M36 x 1.000	6.111,487	4	3

NEW RV-ZN 8.8

Cincada. Calidad 8.8. 1 metro



METAL



CÓDIGO	MEDIDA	€/100	MÉTRICA	LONGITUD	PASO	
9758ZM05	M5 x 1.000	207,617	M5	1.000	,8	100
9758ZM06	M6 x 1.000	213,537	M6	1.000	1	100
9758ZM08	M8 x 1.000	367,940	M8	1.000	1,25	50
9758ZM10	M10 x 1.000	554,530	M10	1.000	1,5	25
9758ZM12	M12 x 1.000	830,640	M12	1.000	1,75	20
9758ZM14	M14 x 1.000	1.141,207	M14	1.000	2	10
9758ZM16	M16 x 1.000	1.406,827	M16	1.000	2	10
9758ZM18	M18 x 1.000	1.944,157	M18	1.000	2,5	5
9758ZM20	M20 x 1.000	2.430,997	M20	1.000	2,5	5
9758ZM22	M22 x 1.000	3.282,487	M22	1.000	2,5	5
9758ZM24	M24 x 1.000	3.439,773	M24	1.000	3	5
9758ZM27	M27 x 1.000	3.941,337	M27	1.000	3	5
9758ZM30	M30 x 1.000	5.124,530	M30	1.000	3,5	5
9758ZM33	M33 x 1.000	6.202,553	M33	1.000	3,5	3
9758ZM36	M36 x 1.000	7.333,787	M36	1.000	4	3

RV-A2

Inoxidable A2. 1 metro

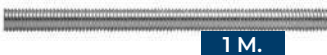

INOXIDABLE



CÓDIGO	MEDIDA	€/100	PASO	
975A2M04	M4 x 1.000	380,780	0,7	1
975A2M05	M5 x 1.000	449,000	0,8	1
975A2M06	M6 x 1.000	619,920	1	1
975A2M08	M8 x 1.000	1.006,010	1,25	1
975A2M10	M10 x 1.000	1.457,350	1,5	1
975A2M12	M12 x 1.000	2.218,653	1,75	1
975A2M14	M14 x 1.000	3.885,137	2	1
975A2M16	M16 x 1.000	4.486,253	2	1
975A2M18	M18 x 1.000	4.894,093	2,5	1
975A2M20	M20 x 1.000	6.753,847	2,5	1
975A2M22	M22 x 1.000	7.894,990	2,5	1
975A2M24	M24 x 1.000	10.657,117	3	1
975A2M27	M27 x 1.000	12.844,027	3	1
975A2M30	M30 x 1.000	19.989,633	3,5	1
975A2M33	M33 x 1.000	25.095,807	3,5	1
975A2M36	M36 x 1.000	28.864,247	4	1



Varilla roscada

RV

METAL



RV-2M

Cincada. 2 metros

CÓDIGO	MEDIDA	€/100	PASO	
975ZM2M06	M6 x 2.000	300,747	1	50



2 M.

Espárrago separador

VR-SE

METAL



CÓDIGO	MEDIDA	€/100		
VRSE06020	M6 x 20	12,153	200	4.800
VRSE06030	M6 x 30	17,090	200	4.800
VRSE08020	M8 x 20	15,893	200	3.200
VRSE08030	M8 x 30	21,287	200	2.400
VRSE10030	M10 x 30	31,257	200	2.400
VRSE12030	M12 x 30	64,071	100	800



Bolsa Autoservicio

CÓDIGO	MEDIDA	€/BOLSA	PCS.	BOLSAS
LSVRSE06030	M6 x 30	6,740	30	8

Manguito de unión

MA

METAL



MA-HE

Hexagonal

CÓDIGO	MEDIDA	€/100	LONGITUD		
MAE0620	M6 x 20	19,803	20	200	2.400
MAE0630	M6 x 30	26,715	30	200	1.600
MAE0825	M8 x 25	21,640	25	200	1.600
MAE1030	M10 x 30	28,802	30	150	900
MAE1235	M12 x 35	67,211	35	100	600
MAE1650	M16 x 50	207,274	50	50	100
MAE2060	M20 x 60	565,844	60	25	-



Blister



Caja con Ventana



Bolsa Autoservicio

CÓDIGO	MEDIDA	€/BOLSA	PCS.	BOLSAS	CÓDIGO	MEDIDA	€/CAJA	PCS.	CAJAS	CÓDIGO	MEDIDA	€/BOLSA	PCS.	BOLSAS
BZMAE0630	M6 x 30	2,565	6	15	VMAE0630	M6 x 30	7,171	20	8	LSMAE0630	M6 x 30	12,429	40	6
BZMAE0825	M8 x 25	2,565	6	15	VMAE0825	M8 x 25	5,788	20	8	LSMAE0825	M8 x 25	7,593	30	5
BZMAE1030	M10 x 30	2,565	4	15	VMAE1030	M10 x 30	6,068	15	8	LSMAE1030	M10 x 30	6,736	20	6

MA

Manguito de unión

MA-RE

Redondo



METAL



CÓDIGO	MEDIDA	€/100	LONGITUD		
MAR5322	5/32W x 20	24,658	20	200	4.800
MAR0420	M4 x 20	16,542	20	200	4.800
MAR0620	M6 x 20	17,455	20	200	2.400
MAR0630	M6 x 30	25,929	30	200	1.600
MAR0825	M8 x 25	21,640	25	200	2.400
MAR0830	M8 x 30	26,838	30	200	1.600
MAR1030	M10 x 30	28,641	30	150	900
MAR1235	M12 x 35	48,393	35	100	600
MAR1650	M16 x 50	172,721	50	50	300



Caja con Ventana

CÓDIGO	MEDIDA	€/CAJA	PCS.	CAJAS
VMAR0420	M4 x 20	5,530	25	8
VMAR0630	M6 x 30	6,935	20	8
VMAR0830	M8 x 30	7,178	20	8
VMAR1030	M10 x 30	5,792	15	8



Bolsa Autoservicio

CÓDIGO	MEDIDA	€/BOLSA	PCS.	BOLSAS
LSMAR0420	M4 x 20	7,736	40	8
LSMAR0630	M6 x 30	12,134	40	7
LSMAR0830	M8 x 30	10,991	35	5
LSMAR1030	M10 x 30	6,759	20	6

MA-RI

Redondo. Inoxidable A2



INOXIDABLE



CÓDIGO	MEDIDA	€/100	LONGITUD	
MARI0830	M8 x 30	207,170	30	100
MARI1030	M10 x 30	285,210	30	100

MA-MH

Separador macho-hembra especial para cuadros eléctricos



METAL



CÓDIGO	MEDIDA	€/100	LONGITUD		
MAMH0610	M6 x 10	44,537	10	100	3.000
MAMH0620	M6 x 20	54,767	20	100	1.200
MAMH0630	M6 x 30	86,370	30	100	1.200
MAMH0640	M6 x 40	98,223	40	100	1.000
MAMH0650	M6 x 50	109,817	50	50	1.000

AR-FO

Argolla forjada



METAL



CÓDIGO	MEDIDA	€/100	Ø OJO	LONGITUD DE LA ROSCA		
ARFOM06Z	M6 x 55	81,027	10	55	100	1.200
ARFOM08Z	M8 x 60	108,623	11.8	60	100	600
ARFOM10Z	M10 x 73	153,213	14.5	73	50	300
ARFOM12Z	M12 x 90	295,803	17	90	50	200
ARFOM16Z	M16 x 95	666,417	23.5	95	25	50



Gancho forjado

GA-FO

METAL



CÓDIGO	MEDIDA	€/100	LONGITUD	APERTURA GANCHO	LONGITUD DE LA ROSCA		
GAFOM06Z	M6 x 55	74,687	82	8	55	100	1.200
GAFOM08Z	M8 x 60	122,840	98	10	60	100	600
GAFOM10Z	M10 x 73	201,100	116,5	12,5	73	50	300
GAFOM12Z	M12 x 90	349,063	146	16	90	50	100
GAFOM16Z	M16 x 95	693,717	170	19	95	25	50



Gancho espiral

GE-SP

METAL



CÓDIGO	MEDIDA	€/100	LONGITUD DE LA ROSCA		
GESPM08ZE	M8 x 60	145,190	65	25	300
GESPM10ZE	M10 x 73	161,370	78	15	90



Tirafondo abrazadera y grapa

TAG



CÓDIGO	MEDIDA	€/100		
ABTA0630	M6 x 30	5,350	100	4.500
ABTA0640	M6 x 40	6,420	100	2.400
ABTA0650	M6 x 50	7,253	100	2.400
ABTA0730*	M7 x 30	5,203	100	2.400
ABTA0740*	M7 x 40	6,420	100	2.400
ABTA0750*	M7 x 50	7,253	100	2.400
ABTA0760*	M7 x 60	12,557	100	1.200
ABTA0770*	M7 x 70	16,543	100	1.200
ABTA0780*	M7 x 80	18,177	100	1.200
ABTA0840	M8 x 40	8,917	100	2.400
ABTA0860	M8 x 60	11,890	100	1.200
ABTA0880	M8 x 80	17,073	100	1.200
ABTA1050	M10 x 50	19,990	100	1.200
ABTA1070	M10 x 70	25,547	100	800
ABTA1090	M10 x 90	31,833	100	600



AB-TA

Cincado. Ranurado



02 Info. Técnica p. 412

*No incorpora ranura



Bolsa Autoservicio

CÓDIGO	MEDIDA	€/BOLSA	PCS.	BOLSAS
LSABTA0630	M6 x 30	2,723	15	10
LSABTA0640	M6 x 40	2,891	15	10
LSABTA0650	M6 x 50	3,068	15	10
LSABTA0840	M8 x 40	3,669	15	10
LSABTA0860	M8 x 60	4,015	15	10



CÓDIGO	MEDIDA	€/100		
ABTAB0630	M6 x 30	5,350	100	4.500
ABTAB0640	M6 x 40	6,420	100	2.400
ABTAB0650	M6 x 50	7,253	100	2.400



AB-TA B

Bicromatado. Ranurado



02 Info. Técnica p. 412



Bolsa Autoservicio

CÓDIGO	MEDIDA	€/BOLSA	PCS.	BOLSAS
LSABTAB0630	M6 x 30	2,723	15	10
LSABTAB0640	M6 x 40	2,891	15	10
LSABTAB0650	M6 x 50	3,068	15	10

TAG

Tirafondo abrazadera y grapa

AB-TA A2

Inoxidable A2



02 Info. Técnica
P. 412

INOXIDABLE



CÓDIGO	MEDIDA	€/100		
ABTA20630	M6 x 30	78,334	100	2.400

AB-TR

Tornillo doble para abrazaderas



02 Info. Técnica
P. 412



CÓDIGO	MEDIDA	€/100		
ABTR05030	M5 x 30	10,047	100	2.400
ABTR05040	M5 x 40	10,403	100	2.400
ABTR05050	M5 x 50	11,597	100	2.400
ABTR05060	M5 x 60	13,737	100	1.200
ABTR06040	M6 x 40	13,273	100	2.400
ABTR06050	M6 x 50	16,100	100	1.200
ABTR06060	M6 x 60	18,487	100	1.200

AB-PM7

Prolongador cilíndrico para abrazaderas M7



CÓDIGO	MEDIDA	€/100		
ABPM720	20	104,347	50	2.250
ABPM730	30	136,737	50	2.250
ABPM740	40	153,987	50	1.200



AB-TG

Tirafondo grapa. Huella combi



02 Info. Técnica
P. 412



CÓDIGO	MEDIDA	€/100			
ABTG4530	4,5 x 30	7,286	PZ2	100	4.500
ABTG4535	4,5 x 35	7,755	PZ2	100	4.500
ABTG4540	4,5 x 40	8,078	PZ2	100	2.400
ABTG5030	5 x 30	9,632	PZ3	100	2.400
ABTG5040	5 x 40	10,197	PZ3	100	2.400

TM-VR

Tornillo manguito para varilla roscada



CÓDIGO	MEDIDA	€/100		
TMVR06065	6 x 65	147,887	50	1.200
TMVR07065	7 x 65	154,937	50	1.200
TMVR08065	8 x 65	158,077	50	1.200



Espárrago de doble rosca

ES-DR



ES-DR

Cincado. Tx

CÓDIGO	MEDIDA		€/100	MXL	SW*		
ESDR06040	M6 x 40	TX15	10,903	M6 x 40	-	100	3.000
ESDR06050	M6 x 50	TX15	13,000	M6 x 50	-	100	2.400
ESDR06060	M6 x 60	TX15	15,010	M6 x 60	-	100	2.400
ESDR06070	M6 x 70	TX15	17,560	M6 x 70	-	100	1.600
ESDR06080	M6 x 80	TX15	19,653	M6 x 80	-	100	1.600
ESDR08050	M8 x 50	TX25	14,750	M8 x 50	-	100	1.600
ESDR08060	M8 x 60	TX25	17,913	M8 x 60	-	100	800
ESDR08070	M8 x 70	TX25	20,503	M8 x 70	-	100	800
ESDR08080	M8 x 80	TX25	23,030	M8 x 80	6	100	800
ESDR08090	M8 x 90	TX25	24,900	M8 x 90	6	100	800
ESDR08100	M8 x 100	TX25	26,693	M8 x 100	6	100	800
ESDR08110	M8 x 110	TX25	30,503	M8 x 110	6	100	800
ESDR08120	M8 x 120	TX25	37,830	M8 x 120	6	100	800
ESDR08130	M8 x 130	TX25	44,660	M8 x 130	6	100	800
ESDR10080	M10 x 80	TX25	35,700	M10 x 80	8	100	800
ESDR10100	M10 x 100	TX25	42,840	M10 x 100	8	100	400
ESDR10110	M10 x 110	TX25	47,737	M10 x 110	8	100	400
ESDR10120	M10 x 120	TX25	59,680	M10 x 120	8	100	400
ESDR10130	M10 x 130	TX25	73,353	M10 x 130	8	100	400
ESDR10140	M10 x 140	TX25	78,063	M10 x 140	8	100	400
ESDR10150	M10 x 150	TX25	82,613	M10 x 150	8	100	400
ESDR10180	M10 x 180	TX25	111,637	M10 x 180	8	100	300
ESDR10200	M10 x 200	TX25	124,113	M10 x 200	8	100	200

02 Info. Técnica
P. 413



Bolsa Autoservicio

CÓDIGO	MEDIDA	€/BOLSA	PCS.	BOLSAS
LSESDR06080	M6 x 80	5,520	25	7
LSESDR08060	M8 x 60	5,659	25	7
LSESDR08080	M8 x 80	7,018	25	6
LSESDR08100	M8 x 100	8,273	25	6
LSESDR08120	M8 x 120	8,412	20	6
LSESDR10080	M10 x 80	7,951	20	6
LSESDR10100	M10 x 100	8,644	18	6
LSESDR10120	M10 x 120	9,138	15	7

*SW: hexágono intermedio



INOXIDABLE



ES-DA2

Inoxidable A2. Tx

CÓDIGO	MEDIDA	€/100		
ESDA208060	M8 x 60	115,807	100	800
ESDA210060	M10 x 60	215,433	100	800

02 Info. Técnica
P. 413



AB-F

Florón para abrazaderas

AB-FP

Florón plano para abrazaderas



CÓDIGO	MEDIDA	€/100		
ABFP25	25	6,503	100	2.400
ABFP32	32	9,563	100	2.400

AB-FC

Florón cónico para abrazaderas



CÓDIGO	MEDIDA	€/100		
ABFC09	9	10,550	100	2.400
ABFC14	14	16,440	100	1.200
ABFC19	19	26,220	100	1.200

PF

Pletina de fijación

PF-ZN

Cincada



METAL



CÓDIGO	MEDIDA	€/100		
PFZNM0800	M8	55,630	100	600
PFZNM0810	M8 + M10	69,940	100	600
PFZNM1000	M10	67,283	100	600

PF-A4

Inoxidable A4



INOXIDABLE



CÓDIGO	MEDIDA	€/100		
PFA4M0800	M8	303,137	100	600
PFA4M0810	M8 + M10	361,303	100	600
PFA4M1000	M10	346,320	100	600

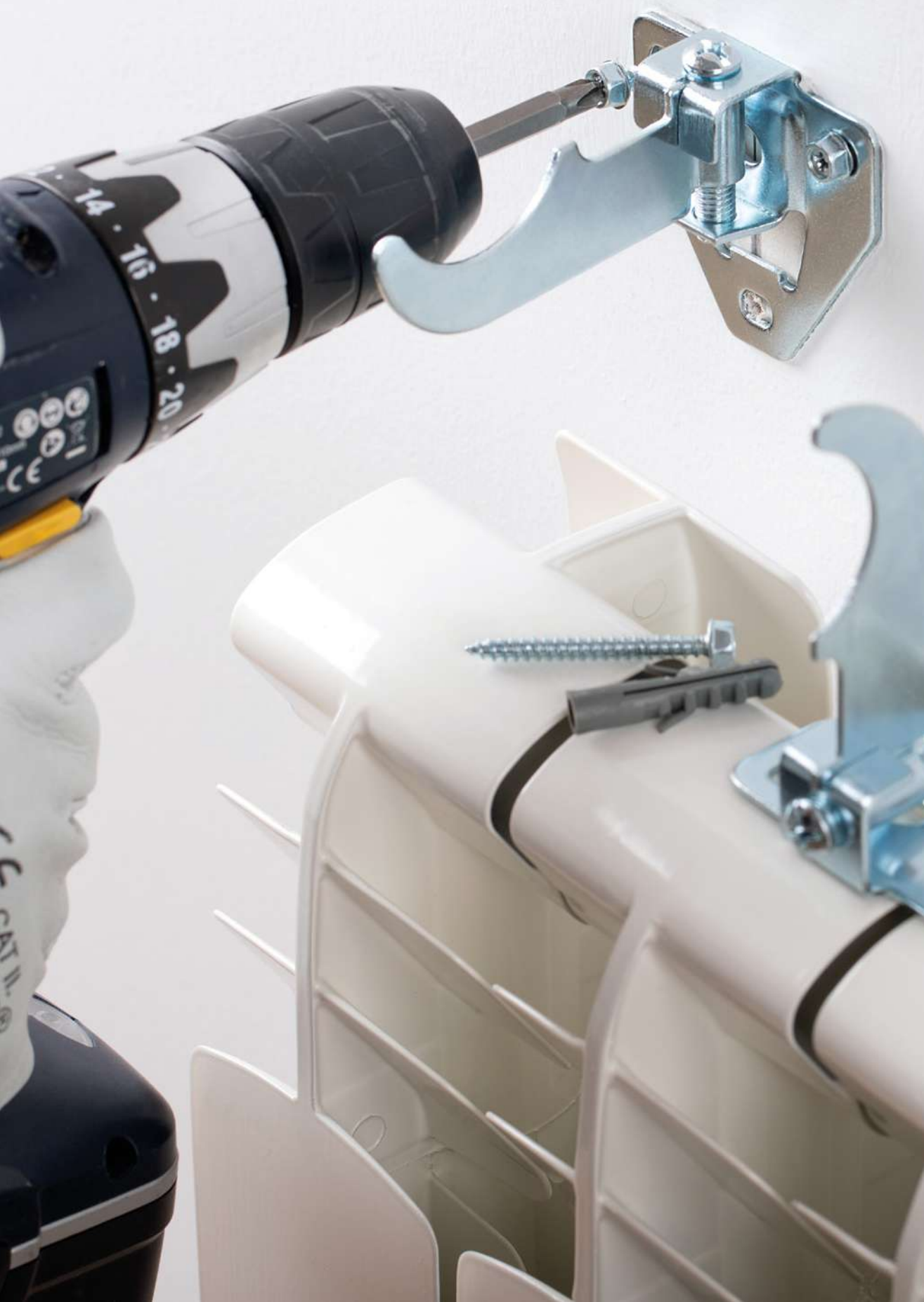

**FIJACIÓN SANITARIOS
Y CLIMATIZACIÓN**



RA

Soportes para radiadores de aluminio

RA-TRG

Soporte triangular regulable con goma antivibraciones



2 PCS
x KIT

TAMBIÉN DISPONIBLE EN
easykits

TN4S
Con taco de multimaterial de alta calidad



CÓDIGO	MEDIDA	€/KIT	KITS X
RATRG095	95	4,496	50

RA-TRI

Soporte triangular 1°



CÓDIGO	MEDIDA	€/100	KITS X
RATRI095	95	142,301	100

RA-FRE

Soporte ferroli recto



2 PCS
x KIT

TN4S
Con taco de multimaterial de alta calidad



CÓDIGO	MEDIDA	€/KIT	KITS X
RAFRE095	95	4,324	50

RA-FIN

Soporte ferroli inclinado



2 PCS
x KIT

TN4S
Con taco de multimaterial de alta calidad



CÓDIGO	MEDIDA	€/KIT	KITS X
RAFIN100	100	4,571	50

Soportes para radiadores de aluminio

RA



CÓDIGO	MEDIDA	€/KIT	KITS X
RAR0100	100	7,158	50



RA-RO

Soporte Roca



CÓDIGO	MEDIDA	€/100	KITS X
RAFEM145	145	125,190	250
RAFEM175	175	131,667	250

RA-FEM

Soporte ferroli para empotrar



CÓDIGO	MEDIDA	€/100	KITS X
RARAY032	32 x 78	101,543	250

RA-RAY

Soporte Rayco

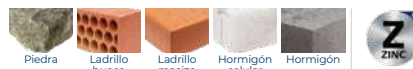

CÓDIGO	MEDIDA	€/100	KITS X
RAPES032	32 x 78	104,403	250

RA-PES

Soporte de pestaña



22 KITS SOLUCIONES

easykits

AUMENTA LA VENTA CRUZADA

PACKAGING MUY VISUAL Y ATRACTIVO

INFORMACIÓN ÚTIL EN EL PACKAGING

SOLUCIONES A PRODUCTOS HABITUALES

SA

Soportes de fijación para sanitarios

SA-LN

Fijación de lavabos con tuerca de nylon



2 PCS
x KIT

TN4S
Con taco de multimaterial de alta calidad



CÓDIGO	MEDIDA	€/KIT	KITS X
SALN08100	M8 x 100	2,120	50
SALN10120	M10 x 120	2,755	50

SA-LH

Fijación de lavabos con tuerca de hierro



2 PCS
x KIT

TAMBIÉN DISPONIBLE EN
easykits

TN4S
Con taco de multimaterial de alta calidad



CÓDIGO	MEDIDA	€/KIT	KITS X
SALH08100	M8 x 100	2,271	100
SALH10120	M10 x 120	3,009	50

SA-IL

Fijación de WC y bidé con taco largo



2 PCS
x KIT



CÓDIGO	MEDIDA	€/KIT	KITS X
SAIL06080	M6 x 80	3,017	100

SA-WZ

Fijación WC y bidé, cincado



2 PCS
x KIT

TN4S
Con taco de multimaterial de alta calidad



CÓDIGO	MEDIDA	€/KIT	KITS X
SAWZ05080	M5 x 80	1,250	300

SA-WL

Fijación WC y bidé, latón



2 PCS
x KIT

TN4S
Con taco de multimaterial de alta calidad



CÓDIGO	MEDIDA	€/KIT	KITS X
SAWL05080	M5 x 80	3,187	100

Soportes de fijación para sanitarios

SA



CÓDIGO	MEDIDA	€/KIT	KITS X
SACI06080	M6 x 80	5,727	100

SA-CI

Fijación de cisterna



2 PCS x KIT

TAMBIÉN DISPONIBLE EN
easykits



CÓDIGO	MEDIDA	€/KIT	KITS X
SAWH06070	M6 x 70	2,184	50

SA-WH

Fijación de WC horizontal



2 PCS x KIT

TN4S
Con taco de multimaterial de alta calidad



CÓDIGO	MEDIDA	€/KIT	KITS X
SAWHM06060	∅6x60	5,458	50

SA-WHM

Fijación WC horizontal multiposición



2 PCS x KIT

TN4S
Con taco de multimaterial de alta calidad



CÓDIGO	MEDIDA	€/100	KITS X
SATEA0860	∅8x60	125,757	50
SATEB1080	∅10x80	222,700	50

SA-TE TB

Fijación de termos y calentadores. Tornillo



2 PCS x KIT

TN4S
Con taco de multimaterial de alta calidad



CÓDIGO	MEDIDA	€/100	KITS X
SATEA0865	∅8x65	119,917	50
SATEA1075	∅10x75	168,137	50

SA-TE AL

Fijación de termos y calentadores. Alcayata



2 PCS x KIT

TN4S
Con taco de multimaterial de alta calidad

CO

Soporte para aire acondicionado



CO-SO

Juego soporte aire acondicionado



2 PCS
x KIT

CÓDIGO	MEDIDA	€/KIT	KITS X
COS015400	1,5 x 400	32,848	1
COS015450	1,5 x 450	35,757	1
COS015500	1,5 x 500	44,049	1
COS020400	2 x 400	49,933	1
COS020450	2 x 450	53,778	1
COS020500	2 x 500	54,947	1



CO-KS

Kit silent block soporte AC



4 PCS
x KIT

CÓDIGO	MEDIDA	€/KIT	KITS X
COKS08060	M8 x 60	7,410	1





EASYKITS

**easy
kits**

EKMULCAN

Canaletas - Rodapiés



MULTIMATERIAL



CÓDIGO	COMPONENTES	MEDIDA COMPONENTES	UDS X BOLSA	€/BOLSA	Nº MINIMO VENTA
EKMULCAN	TCCA05.050	5 x 50 Ø5	8	5,401	12
	BROCA GRATIS	5 x 85	1		

EKMULFAE

Fijacones accesorios exterior



MULTIMATERIAL



CÓDIGO	COMPONENTES	MEDIDA COMPONENTES	UDS X BOLSA	€/BOLSA	Nº MINIMO VENTA
EKMULFAE	TN4506	6 x 30 Ø6	4	5,401	12
	TPA240.050	4 x 50	4		
	BROCA GRATIS	6 x 100	1		

EKMULTEN

Tendederos - Antenas - AC



MULTIMATERIAL



CÓDIGO	COMPONENTES	MEDIDA COMPONENTES	UDS X BOLSA	€/BOLSA	Nº MINIMO VENTA
EKMULTEN	TN4508	8 x 40 Ø8	4	7,655	12
	TBA206.050	6 x 50	4		
	125IM06	M6	4		
	BROCA GRATIS	8 x 120	1		

EKMULAC

Aparatos de aire acondicionado



MULTIMATERIAL



CÓDIGO	COMPONENTES	MEDIDA COMPONENTES	UDS X BOLSA	€/BOLSA	Nº MINIMO VENTA
EKMULAC	TNUXE10.080	10 x 80 Ø10	4	5,409	12
	TN4506	6 x 30 Ø6	4		
	D12.505	M5	4		
	T8142.038	4,2 x 38	4		

EKMULTOL

Toldos



MULTIMATERIAL



CÓDIGO	COMPONENTES	MEDIDA COMPONENTES	UDS X BOLSA	€/BOLSA	Nº MINIMO VENTA
EKMULTOL	TNUXE08.080	8 x 80 Ø8	4	7,655	12
	BROCA GRATIS	8 x 120	1		

MULTIMATERIAL



CÓDIGO	COMPONENTES	MEDIDA COMPONENTES	UDS X BOLSA	€/BOLSA	Nº MINIMO VENTA
EKMULCAL	TN4S10	10 x 50 Ø10	2	7,655	12
	TB06.060	4 x 50	2		
	ALRO22.100	22x100 (6 x 79 x 23)	2		
	BROCA GRATIS	10 x 120	1		

EKMULCAL

Calderas - Calentadores



MULTIMATERIAL



CÓDIGO	COMPONENTES	MEDIDA COMPONENTES	UDS X BOLSA	€/BOLSA	Nº MINIMO VENTA
EKMULAV08	SALH08.100	M8 x 100	2	7,655	12
	BROCA GRATIS	8 x 120	11		
EKMULAV10	SALH10.120	M10 x 120	2	11,478	12
	BROCA GRATIS	10 x 120	1		

EKMULAV

Lavabos



MULTIMATERIAL



CÓDIGO	COMPONENTES	MEDIDA COMPONENTES	UDS X BOLSA	€/BOLSA	Nº MINIMO VENTA
EKMULCIS	SACIO6.080	M6 x 80	2	11,478	12

EKMULCIS

Cisternas WC



MULTIMATERIAL



CÓDIGO	COMPONENTES	MEDIDA COMPONENTES	UDS X BOLSA	€/BOLSA	Nº MINIMO VENTA
EKMULWCB	SAWZ05.080	M5 x 80	2	7,655	12
	BROCA GRATIS	8 x 120	1		

EKMULWCB

WC - Bidés



MULTIMATERIAL



CÓDIGO	COMPONENTES	MEDIDA COMPONENTES	UDS X BOLSA	€/BOLSA	Nº MINIMO VENTA
EKMULRAD	RATRG095	95	2	14,348	12
	BROCA GRATIS	8 x 120	1		

EKMULRAD

Radiadores



EKMULROB

Antirrobo



MULTIMATERIAL



CÓDIGO	COMPONENTES	MEDIDA COMPONENTES	UDS X BOLSA	€/BOLSA	Nº MINIMO VENTA
EKMULROB	TN4S10	10 x 50 Ø10	4	8,190	12
	INVN7.070	7 x 70	4		
	BROCA GRATIS	10 x 120	1		

EKMACILU

Iluminación - Cuadros



MACIZOS



CÓDIGO	COMPONENTES	MEDIDA COMPONENTES	UDS X BOLSA	€/BOLSA	Nº MINIMO VENTA
EKMACILU	TN4S06	6 x 30 Ø6	4	5,401	12
	TPPOZ40.045	4 x 45	4		
	ALRO18.050	18x50 (3,7 x 37 x 15)	4		
	BROCA GRATIS	6 x 100	1		

EKHUEILU

Iluminación - Cuadros

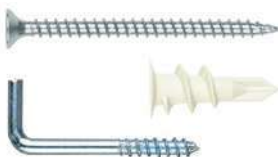

HUECOS



CÓDIGO	COMPONENTES	MEDIDA COMPONENTES	UDS X BOLSA	€/BOLSA	Nº MINIMO VENTA
EKHUEILU	TAPLANY	15 x 33	4	5,401	12
	TPPOZ45.045	4,5 x 45	4		
	ALRO19.050	19x50 (4,4 x 37 x 15)	4		

EKMACFTP

Fijaciones techo pesadas



MACIZOS



CÓDIGO	COMPONENTES	MEDIDA COMPONENTES	UDS X BOLSA	€/BOLSA	Nº MINIMO VENTA
EKMACFTP	TN4S10	10 x 50 Ø10	4	7,655	12
	TB06.060	6 x 60	4		
	D12.506	M6	4		
	BROCA GRATIS	10 x 120	1		

EKHUEFTP

Cisternas WC



HUECOS



CÓDIGO	COMPONENTES	MEDIDA COMPONENTES	UDS X BOLSA	€/BOLSA	Nº MINIMO VENTA
EKHUEFTP	BAESM06	M6 Ø16	4	7,655	12

EKMACFTL

Fijaciones techo ligeras



MACIZOS



CÓDIGO	COMPONENTES	MEDIDA COMPONENTES	UDS X BOLSA	€/BOLSA	Nº MINIMO VENTA
EKMACFTL	TN4S06	6 x 30 Ø6	4	5,401	12
	TPPOZ40.040	4 x 40	4		
	BROCA GRATIS	6 x 100	1		

HUECOS



CÓDIGO	COMPONENTES	MEDIDA COMPONENTES	UDS X BOLSA	€/BOLSA	N° MINIMO VENTA
EKHUEFTL	BAESM04	M4 Ø14	2	5,401	12

EKHUEFTL

Fijaciones techo ligeras

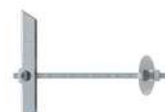

MACIZOS



CÓDIGO	COMPONENTES	MEDIDA COMPONENTES	UDS X BOLSA	€/BOLSA	N° MINIMO VENTA
EKMACFTG	TN4S06	6 x 30 Ø6	4	5,401	12
	ALHA19.070	19x70 (4,4 x 41 x 15)	4		
	BROCA GRATIS	6 x 100	1		

EKMACFTG

Fijaciones techo pesadas



HUECOS



CÓDIGO	COMPONENTES	MEDIDA COMPONENTES	UDS X BOLSA	€/BOLSA	N° MINIMO VENTA
EKHUEFTG	BAGAM06	10 x 80 Ø10	2	5,401	12

EKHUEFTG

Fijaciones techo gancho



MULTIMATERIAL



CÓDIGO	COMPONENTES	MEDIDA COMPONENTES	UDS X BOLSA	€/BOLSA	N° MINIMO VENTA
EKMULFAP	TN4S08	8 x 40 Ø8	4	7,655	12
	TPPOZ05.050	5 x 50	4		
	ALRO19.050	19x50 (4,4 x 37 x 15)	4		
	BROCA GRATIS	8 x 120	1		

EKMULFAP

Fijaciones accesorios pesados



MULTIMATERIAL



CÓDIGO	COMPONENTES	MEDIDA COMPONENTES	UDS X BOLSA	€/BOLSA	N° MINIMO VENTA
EKMULFAL	TN4S05	5 x 25 Ø5	4	5,401	12
	TPPOZ35.030	3,5 x 30	4		
	ALRO17.040	17x40 (3,5 x 29 x 13)	4		
	BROCA GRATIS	5 x 85	1		

EKMULFAL

Pequeñas fijaciones





**GAMA
INOX**



MT

Anclaje macho para cargas altas en hormigón fisurado y no fisurado

NEW MTP-A4

Homologado ETE Opción 1. Eje Inoxidable A4. Clip Inoxidable A4.



02 Info. Técnica P. 341



CÓDIGO	MEDIDA	€/100	ESPESOR MÁX. A FIJAR	LETRA EJE (LONGITUD)		
APA408075	M8 x 75 Ø8	364,020	9	C	100	600
APA408095	M8 x 95 Ø8	411,667	29	E	100	600
APA408115	M8 x 115 Ø8	539,780	49	G	100	400
APA408135	M8 x 135 Ø8	624,493	69	H	50	300
APA410090	M10 x 90 Ø10	641,667	10	E	100	400
APA410105	M10 x 105 Ø10	686,170	25	F	50	300
APA410115	M10 x 115 Ø10	755,890	35	G	50	300
APA410135	M10 x 135 Ø10	906,770	55	H	50	300
APA410165	M10 x 165 Ø10	1.082,000	85	K	50	100
APA410185	M10 x 185 Ø10	1.157,987	105	L	50	100
APA412110	M12 x 110 Ø12	931,650	14	F	50	200
APA412120	M12 x 120 Ø12	999,500	24	G	50	200
APA412130	M12 x 130 Ø12	1.085,333	34	H	50	200
APA412150	M12 x 150 Ø12	1.268,333	54	I	50	100
APA412180	M12 x 180 Ø12	1.403,000	84	L	50	150
APA412200	M12 x 200 Ø12	1.477,703	104	M	50	100
APA416125	M16 x 125 Ø16	1.918,000	8	G	50	100
APA416145	M16 x 145 Ø16	2.152,667	28	I	25	100
APA416175	M16 x 175 Ø16	2.819,333	58	K	25	50
APA416190	M16 x 190 Ø16	2.919,667	73	L	25	50
APA416220	M16 x 220 Ø16	3.109,720	103	O	20	40
APA420200	M20 x 200 Ø20	4.798,200	62	M	20	40
APA420240	M20 x 240 Ø20	5.507,167	102	P	15	30
APA420285	M20 x 285 Ø20	6.478,589	147	S	10	20

MTH-A4

Homologado ETE Opción 7. Eje Inoxidable A4. Clip Inoxidable A4.



02 Info. Técnica P. 344

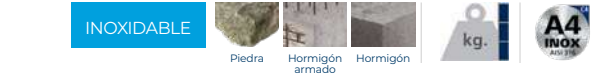

CÓDIGO	MEDIDA	€/100	ESPESOR MÁX. A FIJAR	LETRA EJE (LONGITUD)		
•MIA406045	M6 x 45 Ø6	198,050	1	A	200	1.200
•MIA406060	M6 x 60 Ø6	215,763	2	B	200	1.200
•MIA406080	M6 x 80 Ø6	229,800	22	D	200	1.200
•MIA408050	M8 x 50 Ø8	238,740	4	A	100	800
MIA408075	M8 x 75 Ø8	253,527	5	C	100	600
MIA408090	M8 x 90 Ø8	282,907	20	E	100	600
MIA408115	M8 x 115 Ø8	371,653	45	G	100	400
MIA410070	M10 x 70 Ø10	415,217	3	C	100	400
MIA410090	M10 x 90 Ø10	470,627	10	D	100	400
MIA410120	M10 x 120 Ø10	572,090	40	G	50	300
MIA410150	M10 x 150 Ø10	811,337	70	I	50	200
•MIA412075	M12 x 75 Ø12	620,927	5	C	50	300
MIA412090	M12 x 90 Ø12	625,313	13	D	50	200
MIA412110	M12 x 110 Ø12	684,030	12	F	50	200
MIA412140	M12 x 140 Ø12	820,253	42	I	50	200
•MIA416090	M16 x 90 Ø16	1.483,607	4	D	25	150
MIA416145	M16 x 145 Ø16	1.832,207	23	I	25	100
MIA416170	M16 x 170 Ø16	2.115,780	48	K	25	75
•MIA420120	M20 x 120 Ø20	2.459,464	5	G	20	40
MIA420170	M20 x 170 Ø20	3.361,992	23	K	20	40
MIA420220	M20 x 220 Ø20	4.185,353	73	O	20	40



• Medidas sin homologar
• Medida sin homologar para fuego

Caja con Ventana

CÓDIGO	MEDIDA	€/CAJA	PCS.	CAJAS
VMIA408075	M8 x 75 Ø8	34,754	10	8
VMIA410090	M10 x 90 Ø10	47,562	8	8
VMIA412110	M12 x 110 Ø12	54,416	6	8

Bolsa Autoservicio

CÓDIGO	MEDIDA	€/BOLSA	PCS.	BOLSAS
LSMIA408075	M8 x 75 Ø8	38,350	12	7
LSMIA410090	M10 x 90 Ø10	50,066	8	7
LSMIA412110	M12 x 110 Ø12	54,502	6	5

Anclaje macho para cargas altas en hormigón fisurado y no fisurado

MT

INOXIDABLE

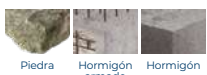

MTH-A2

Homologado ETE Opción 7. Eje Inoxidable A2. Clip Inoxidable A2.



CÓDIGO	MEDIDA	€/100	ESPESOR MÁX. A FIJAR	LETRA EJE (LONGITUD)		
•MI06045	M6 x 45 Ø6	161,603	1	A	200	1.200
•MI06060	M6 x 60 Ø6	181,233	2	B	200	1.200
•MI06080	M6 x 80 Ø6	189,553	22	D	200	1.200
•MI06120	M6 x 120 Ø6	226,723	62	G	100	600
•MI06140	M6 x 140 Ø6	286,957	82	I	100	600
•MI06160	M6 x 160 Ø6	321,420	102	J	100	400
•MI06170	M6 x 170 Ø6	360,995	112	K	100	400
•MI06180	M6 x 180 Ø6	391,449	122	L	100	300
•MI08050	M8 x 50 Ø8	195,990	4	A	100	800
MI08075	M8 x 75 Ø8	214,680	5	C	100	600
MI08090	M8 x 90 Ø8	244,303	20	E	100	600
MI08115	M8 x 115 Ø8	316,020	45	G	100	400
MI10070	M10 x 70 Ø10	332,170	3	C	100	400
MI10090	M10 x 90 Ø10	371,820	10	D	100	400
MI10120	M10 x 120 Ø10	435,813	40	G	50	300
MI10150	M10 x 150 Ø10	610,167	70	I	50	200
•MI12075	M12 x 75 Ø12	503,667	5	C	50	300
MI12090	M12 x 90 Ø12	504,820	13	D	50	200
MI12110	M12 x 110 Ø12	546,373	18	F	50	200
MI12140	M12 x 140 Ø12	684,810	48	I	50	200
•MI16090	M16 x 90 Ø16	1.223,710	4	D	25	150
MI16145	M16 x 145 Ø16	1.428,494	23	I	25	100
MI16170	M16 x 170 Ø16	1.566,360	48	K	25	75
•MI20120	M20 x 120 Ø20	1.957,302	5	G	20	40
MI20170	M20 x 170 Ø20	2.432,095	23	K	20	40
MI20220	M20 x 220 Ø20	3.141,695	73	O	20	40

• Medidas sin homologar
• Medida sin homologar para fuego



DO-MT
Util de colocación PÁG. 47



Blister



Caja con Ventana



Bolsa Autoservicio

CÓDIGO	MEDIDA	€/BOLSA	PCS.	BOLSAS
BZMI08075	M8 x 75 Ø8	4,622	2	12
BZMI10090	M10 x 90 Ø10	4,622	2	10

CÓDIGO	MEDIDA	€/CAJA	PCS.	CAJAS
VMI08075	M8 x 75 Ø8	31,479	10	8
VMI08090	M8 x 90 Ø8	33,657	10	8
VMI10070	M10 x 70 Ø10	34,779	8	8
VMI10090	M10 x 90 Ø10	38,931	8	8
VMI10120	M10 x 120 Ø10	34,224	6	8
VMI12110	M12 x 110 Ø12	42,459	6	8

CÓDIGO	MEDIDA	€/BOLSA	PCS.	BOLSAS
LSMI08075	M8 x 75 Ø8	31,948	12	7
LSMI08090	M8 x 90 Ø8	36,352	12	7
LSMI10070	M10 x 70 Ø10	39,130	10	6
LSMI10090	M10 x 90 Ø10	38,931	8	6
LSMI10120	M10 x 120 Ø10	41,070	8	6
LSMI12110	M12 x 110 Ø12	42,459	6	6

MACIZOS



CÓDIGO	MEDIDA	€/PC		
DOMTA10	M6 - M8 - M10	13,097	5	225
DOMTA20	M12 - M14 - M16 - M20	21,831	5	225

DO-MT

Util de colocación para Familia MT



CH

Anclaje antigiro para cargas medias

CH-A2

Inoxidable A2. Homologado ETE Opt.7

INOXIDABLE

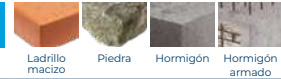

02 Info Técnica
p. 351



CÓDIGO	MEDIDA	€/100		
ACHTA208C	M6 x 45 Ø8	108,713	100	1.200
ACHTA208L	M6 x 60 Ø8	122,817	100	600
•ACHTA209C	M6 x 45 Ø9	123,027	100	1.200
•ACHTA209L	M6 x 60 Ø9	142,097	100	600
ACHTA210C	M8 x 60 Ø10	176,140	100	600
ACHTA210L	M8 x 80 Ø10	202,623	100	400
•ACHTA211C	M8 x 60 Ø11	211,907	100	400
•ACHTA211L	M8 x 80 Ø11	249,623	100	400
ACHTA212C	M10 x 70 Ø12	297,137	100	200
ACHTA212L	M10 x 100 Ø12	363,387	50	200
•ACHTA214C	M10 x 70 Ø14	395,263	100	300
•ACHTA214L	M10 x 100 Ø14	440,873	50	200
ACHTA216C	M12 x 80 Ø16	585,907	50	100
ACHTA216L	M12 x 110 Ø16	741,410	50	100
ACHTA220C	M16 x 110 Ø20	1.522,157	25	75

• Medidas sin homologar



Blister



Caja con Ventana



Bolsa Autoservicio

CÓDIGO	MEDIDA	€/BOLSA	PCS. BOLSAS		CÓDIGO	MEDIDA	€/CAJA	PCS. CAJAS		CÓDIGO	MEDIDA	€/BOLSA	PCS. BOLSAS	
BZACHTA208C	M6 x 45 Ø8	4,622	2 15		VACHTA208C	M6 x 45 Ø8	13,641	10 8		LSACHTA208C	M6 x 45 Ø8	14,734	12 6	
BZACHTA208L	M6 x 60 Ø8	4,622	2 15		VACHTA208L	M6 x 60 Ø8	15,859	10 8		LSACHTA208L	M6 x 60 Ø8	17,128	12 6	
BZACHTA210C	M8 x 60 Ø10	4,622	2 15		VACHTA210C	M8 x 60 Ø10	14,204	6 8		LSACHTA210C	M8 x 60 Ø10	17,044	8 6	
BZACHTA210L	M8 x 80 Ø10	4,622	2 15		VACHTA210L	M8 x 80 Ø10	16,912	6 8		LSACHTA210L	M8 x 80 Ø10	20,293	8 6	
					VACHTA212C	M10 x 70 Ø12	15,938	4 8		LSACHTA212C	M10 x 70 Ø12	21,519	6 6	
					VACHTA212L	M10 x 100 Ø12	19,673	4 8		LSACHTA212L	M10 x 100 Ø12	19,673	4 5	

CH-PI

Cabeza plana inoxidable A2. Homologado ETE Opt.7

INOXIDABLE

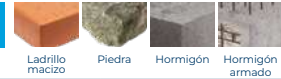

02 Info Técnica
p. 352



CÓDIGO	MEDIDA	€/100			
ACHTPI08C	M6 x 45 Ø8	116,590	4	100	1.200
ACHTPI08L	M6 x 60 Ø8	149,287	4	100	1.200
ACHTPI10C	M8 x 60 Ø10	219,947	5	100	600
ACHTPI10L	M8 x 80 Ø10	260,373	5	100	400
ACHTPI12C	M10 x 70 Ø12	347,790	6	50	300
ACHTPI12L	M10 x 100 Ø12	410,607	6	50	300

CH-GF A2

Gancho forjado. Inoxidable A2

INOXIDABLE

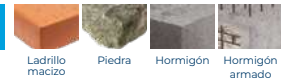

02 Info Técnica
p. 353

CÓDIGO	MEDIDA	€/100	APERTURA GANCHO		
ACHGA208C	M6 x 45 Ø8	414,233	10	100	600
ACHGA210C	M8 x 60 Ø10	615,310	11	100	400
ACHGA212C	M10 x 70 Ø12	857,143	14	50	200

Anclaje antigiro para cargas medias

CH

INOXIDABLE



CÓDIGO	MEDIDA	€/100	Ø OJO		
ACHAA208C	M6 x 45 Ø8	454,853	10	100	600
ACHAA210C	M8 x 60 Ø10	725,567	11	100	400
ACHAA212C	M10 x 70 Ø12	986,037	14	50	200

CH-AF A2

Argolla forjada. Inoxidable A2



02
P. 353
Info.
Técnica

Anclaje hembra con cono interior para grandes cargas

HE

INOXIDABLE



CÓDIGO	MEDIDA	€/100	LONGITUD		
HEA4M06	M6 x 25 Ø8	110,967	25	100	4.000
HEA4M08	M8 x 30 Ø10	158,223	30	100	2.200
HEA4M10	M10 x 40 Ø12	237,783	40	50	1.000
HEA4M12	M12 x 50 Ø15	473,433	50	50	600
HEA4M16	M16 x 65 Ø20	1.057,930	65	25	250
HEA4M20	M20 x 80 Ø25	1.932,287	80	25	100

HE-A4

Inoxidable A4. Homologado ETE
Aplicaciones no estructurales



02
P. 354
Info.
Técnica



INOXIDABLE



CÓDIGO	MEDIDA	€/100	LONGITUD		
HEC4M06	M6 x 25 Ø8	152,948	25	100	3.200
HEC4M08	M8 x 30 Ø10	218,993	30	100	1.600
HEC4M10	M10 x 40 Ø12	338,341	40	50	800
HEC4M12	M12 x 50 Ø15	608,319	50	50	400

HE-C4 NEW

Con collarín. Inoxidable A4.
Homologado ETE Aplicaciones no
estructurales



02
P. 354
Info.
Técnica



Anclaje de acero con aletas para cargas altas

AC

INOXIDABLE



CÓDIGO	MEDIDA	€/100	LONGITUD CÁPSULA		
AACCI06	M6 x 40 Ø10	464,670	40	50	1.200
AACCI08	M8 x 50 Ø14	842,543	50	50	600
AACCI10	M10 x 60 Ø16	942,803	60	25	300
AACCI12	M12 x 80 Ø20	1.744,203	80	10	120

AC-CI

Cápsula. Inoxidable A4



02
P. 357
Info.
Técnica

HI

Anclaje antigiro para cargas altas

HI-CI

Cápsula. Inoxidable A2



02
P. 358
Info.
Técnica

INOXIDABLE



CÓDIGO	MEDIDA	€/100	LONGITUD CÁPSULA		
AHICI0645	M6 x 45 Ø12	600,255	40	100	600
AHICI0855	M8 x 55 Ø14	843,040	48	50	600
AHICI1065	M10 x 65 Ø16	1.125,520	59	50	300

AV

Anclaje para fachadas ventiladas

AVR

Roscado



INOXIDABLE



CÓDIGO	MEDIDA	€/100		
AVR08120	M8 x 120 Ø8	311,053	100	600
AVR08150	M8 x 150 Ø8	344,967	100	600
AVR10120	M10 x 120 Ø10	388,977	100	400
AVR10150	M10 x 150 Ø10	445,140	100	200
AVR10180	M10 x 180 Ø10	495,263	100	200

AVC

Corrugado



INOXIDABLE



CÓDIGO	MEDIDA	€/100		
AVC08120	8 x 120 Ø8	335,017	100	600
AVC08150	8 x 150 Ø8	375,020	100	600
AVC10120	10 x 120 Ø10	428,867	100	400
AVC10150	10 x 150 Ø10	491,217	100	200
AVC10180	10 x 180 Ø10	554,563	100	200

EQ

Espárrago para anclaje químico con tuerca y arandela

EQ-A2

Inoxidable A2



QUÍMICOS



CÓDIGO	MEDIDA	€/100		
EQA208110	M8 x 110	310,533	10	240
EQA210130	M10 x 130	513,190	10	120
EQA212160	M12 x 160	850,517	10	120
EQA216190	M16 x 190	1.762,247	10	40
EQA220260	M20 x 260	3.368,117	6	12
EQA224300	M24 x 300	5.382,437	6	12
EQA230330	M30 x 330	9.820,060	6	12

Espárrago para anclaje químico con tuerca y arandela

EQ



CÓDIGO	MEDIDA	€/100		
EQA408110	M8 x 110	356,573	10	240
EQA410130	M10 x 130	647,677	10	120
EQA412160	M12 x 160	1.114,120	10	120
EQA416190	M16 x 190	2.297,417	10	40
EQA420260	M20 x 260	5.313,967	6	12
EQA424300	M24 x 300	8.758,463	6	12
EQA430330	M30 x 330	15.449,990	6	12

EQ-A4

Inoxidable A4



Taco de nylon universal de alto rendimiento

T-NUX



CÓDIGO	MEDIDA	€/100		ESPESOR MÁX. A FIJAR		
TNXA408080	8 x 80 Ø8	264,814	TX30	10	50	600
TNXA408100	8 x 100 Ø8	319,321	TX30	30	50	600
TNXA408120	8 x 120 Ø8	394,477	TX30	50	50	300
TNXA410080	10 x 80 Ø10	337,061	TX40	10	50	300
TNXA410100	10 x 100 Ø10	402,435	TX40	30	50	300
TNXA410120	10 x 120 Ø10	468,663	TX40	50	50	300
TNXA410140	10 x 140 Ø10	555,749	TX40	70	50	300

T-NUX A A4

Inoxidable A4. Cabeza avellanada.
Homologado ETE



02
P. 364
Info.
Técnica

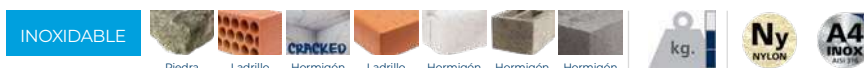

CÓDIGO	MEDIDA	€/100			ESPESOR MÁX. A FIJAR		
TNXE408080	8 x 80 Ø8	371,738	TX30	H10	10	50	600
TNXE408100	8 x 100 Ø8	440,603	TX30	H10	30	50	300
TNXE410080	10 x 80 Ø10	493,074	TX40	H13	10	50	300
TNXE410100	10 x 100 Ø10	514,943	TX40	H13	30	50	300
TNXE410120	10 x 120 Ø10	618,968	TX40	H13	50	50	300
TNXE410140	10 x 140 Ø10	722,024	TX40	H13	70	50	200

T-NUX E A4

Inoxidable A4. Cabeza hexagonal.
Homologado ETE



02
P. 364
Info.
Técnica



Taco clavable de poliamida 6.6, premontado con tornillo rosca-arpon

TC

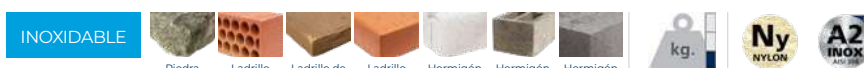

CÓDIGO	MEDIDA	€/100		ESPESOR MÁX. A FIJAR		
TCA205030	5 x 30 Ø5	38,072	PZ2	5	100	2.400
TCA206040	6 x 40 Ø6	52,017	PZ2	10	100	1.200
TCA206060	6 x 60 Ø6	64,710	PZ2	30	100	1.200
TCA208060	8 x 60 Ø8	101,847	PZ3	20	100	600
TCA208080	8 x 80 Ø8	119,480	PZ3	40	100	600
TCA208100	8 x 100 Ø8	157,150	PZ3	60	100	600

TC-A2

Taco con cabeza avellanada y tornillo
inoxidable A2



02
P. 366
Info.
Técnica

DIN-7504-K Tornillo autotaladrante de cabeza hexagonal

DIN-7504-K A2

Tornillo. Inoxidable A2



INOXIDABLE



CÓDIGO	MEDIDA	€/100			
ABEI4213	4,2 x 13	17,927	7	1.000	12.000
ABEI4216	4,2 x 16	20,113	7	1.000	8.000
ABEI4219	4,2 x 19	20,847	7	1.000	8.000
ABEI4813	4,8 x 13	25,360	8	1.000	8.000
ABEI4816	4,8 x 16	24,780	8	500	6.000
ABEI4819	4,8 x 19	26,817	8	500	6.000
ABEI4825	4,8 x 25	30,027	8	500	6.000
ABEI4832	4,8 x 32	35,707	8	500	3.000
ABEI5519	5,5 x 19	37,023	8	500	6.000
ABEI5522	5,5 x 22	39,500	8	500	4.000
ABEI5525	5,5 x 25	41,980	8	500	6.000
ABEI6319	6,3 x 19	56,113	10	500	3.000
ABEI6325	6,3 x 25	63,840	10	500	3.000

ABE BIMETAL Tornillo autotaladrante inoxidable bimetálico con cabeza hexagonal

ABE BIMETAL

Tornillo



METAL



CÓDIGO	MEDIDA	€/100		CAPACIDAD DE TALADRADO		
BIE4825	4,8 x 25	75,343	8	1,75-4,40	500	6.000
BIE5525	5,5 x 25	86,440	8	1,75-5,25	500	6.000
BIE5532	5,5 x 32	101,427	8	1,75-5,25	500	3.000
BIE5538	5,5 x 38	105,547	8	1,75-5,25	500	3.000
BIE5550	5,5 x 50	121,823	8	1,75-5,25	500	2.000
BIE5558	5,5 x 58	135,590	8	1,75-5,25	250	1.500
BIE5565	5,5 x 65	141,720	8	1,75-5,25	250	1.500
BIE5580	5,5 x 80	167,200	8	1,75-5,25	250	1.000
BIE6325	6,3 x 25	92,240	10	2,50-6,00	500	3.000

ABE BIMETAL + ARVUL

Tornillo con arandela vulcanizada de acero-EPDM



METAL





CÓDIGO	MEDIDA	€/100		CAPACIDAD DE TALADRADO		
BIE164825	4,8 x 25 P16	88,448	8	1,75-4,40	500	2.000
BIE165525	5,5 x 25 P16	102,467	8	1,75-5,25	500	2.000
BIE165532	5,5 x 32 P16	119,110	8	1,75-5,25	500	2.000
BIE165538	5,5 x 38 P16	122,609	8	1,75-5,25	500	1.500
BIE165550	5,5 x 50 P16	143,010	8	1,75-5,25	500	1.500
BIE165558	5,5 x 58 P16	153,868	8	1,75-5,25	250	1.500
BIE165565	5,5 x 65 P16	160,132	8	1,75-5,25	250	1.500
BIE165580	5,5 x 80 P16	186,347	8	1,75-5,25	250	1.000
BIE166325	6,3 x 25 P16	108,997	10	2,50-6,00	500	2.000

Tornillo viga autotaladrante inoxidable bimet con cabeza hexagonal

AUTO BIMETAL





CÓDIGO	MEDIDA	€/100		ESPEJOR MÁX. A FIJAR	CAPACIDAD DE TALADRADO		
BAUTO5540	5,5 x 40	128,757	8	10	4,00-12,00	500	3.000
BAUTO5550	5,5 x 50	182,827	8	20	4,00-12,00	500	3.000
BAUTO5565	5,5 x 65	190,993	8	35	4,00-12,00	250	1.500
BAUTO5580	5,5 x 80	240,070	8	50	4,00-12,00	250	1.000
BAUTO5510	5,5 x 100	242,763	8	70	4,00-12,00	100	600

AUTO BIMETAL

Tornillo



CÓDIGO	MEDIDA	€/100		ESPEJOR MÁX. A FIJAR	CAPACIDAD DE TALADRADO		
BAUTO165540	5,5 x 40 P16	155,930	8	8	4,00-12,00	500	1.500
BAUTO165550	5,5 x 50 P16	210,793	8	18	4,00-12,00	500	1.500
BAUTO165565	5,5 x 65 P16	217,797	8	33	4,00-12,00	250	1.500
BAUTO165580	5,5 x 80 P16	255,990	8	48	4,00-12,00	250	1.000
BAUTO165510	5,5 x 100 P16	269,887	8	68	4,00-12,00	100	600

AUTO BIMETAL + ARVUL

Tornillo con arandela vulcanizada de acero-EPDM



Tornillo autotaladrante de cabeza hexagonal para panel sándwich

PS



CÓDIGO	MEDIDA	€/100		ESPEJOR MÁX. A FIJAR	CAPACIDAD DE TALADRADO		
PS1955195	5,5 / 6,3 x 195 P19	289,230	8	130 - 185	1,50-6,00	200	400
PS1955230	5,5 / 6,3 x 230 P19	406,007	8	166 - 215	1,50-6,00	200	-

PS 3 + ARVUL A2

Punta broca estándar #3 con recubrimiento ATLANTIS C4-M y arandela inoxidable A2



CÓDIGO	MEDIDA	€/100		ESPEJOR MÁX. A FIJAR	CAPACIDAD DE TALADRADO		
PSL1955255	5,5 / 6,3 x 255 P19	565,423	8	170 - 210	6,00-12,00	200	-
PSL1955285	5,5 / 6,3 x 285 P19	993,677	8	200 - 250	6,00-12,00	200	-

PS 5 + ARVUL A2

Punta broca extra larga #5 con recubrimiento ATLANTIS C4-M y arandela inoxidable A2



ARVUL

Arandela vulcanizada de acero-EPDM

ARVUL A2

Inoxidable A2



INOXIDABLE



CÓDIGO	MEDIDA	€/100	Ø INTERIOR ARANDELA		
ARINO14	P14	12,053	2,5	1.000	12.000
ARINO16	P16	13,627	2,7	1.000	6.000
ARINO18	P18	17,147	3,2	1.000	6.000
ARINO25	P25	31,707	3,3	500	3.000
ARINOM30	P30	45,500	6,3	500	1.500



* ARINOM30: Especial instalaciones con anclaje MTH-A2, Ø6.

DIN-7504-N HP

Tornillo autotaladrante de cabeza alomada y huella PH

DIN-7504-N HP A2

Inoxidable A2. Huella PH

INOXIDABLE



CÓDIGO	MEDIDA	€/100		ESPESOR MÁX. A FIJAR	CAPACIDAD DE TALADRADO		
ABRA23509	3,5 x 9,5	11,723	PH2	2,85	0,70-2,25	1.000	24.000
ABRA23513	3,5 x 13	14,147	PH2	6,2	0,70-2,25	500	12.000
ABRA23519	3,5 x 19	17,333	PH2	12,1	0,70-2,25	500	12.000
ABRA24213	4,2 x 13	16,567	PH2	4,3	1,75-3,00	500	12.000
ABRA24216	4,2 x 16	18,560	PH2	7,3	1,75-3,00	500	12.000
ABRA24219	4,2 x 19	19,753	PH2	10,3	1,75-3,00	500	12.000
ABRA24225	4,2 x 25	20,747	PH2	16,3	1,75-3,00	250	6.000
ABRA24816	4,8 x 16	25,990	PH2	5,5	1,75-4,40	250	6.000
ABRA24819	4,8 x 19	25,460	PH2	8,7	1,75-4,40	250	6.000
ABRA24825	4,8 x 25	28,290	PH2	14,7	1,75-4,40	250	6.000
ABRA24832	4,8 x 32	33,113	PH2	21,5	1,75-4,40	250	4.000
ABRA24838	4,8 x 38	36,250	PH2	27,5	1,75-4,40	250	3.000
ABRA24850	4,8 x 50	42,743	PH2	39,5	1,75-4,40	250	3.000

BCP

Tornillo autotaladrante de cabeza extraplana y huella PH

BCP A2

Inoxidable A2. Huella PH

INOXIDABLE



CÓDIGO	MEDIDA	€/100		ESPESOR MÁX. A FIJAR	CAPACIDAD DE TALADRADO		
BCPA24214	4,2 x 14	24,470	PH2	6	0,70-2,00	500	12.000

CP

Tornillo rosca chapa con cabeza extraplana y huella PH

CP A2

Inoxidable A2. Huella PH

INOXIDABLE



CÓDIGO	MEDIDA	€/100		ESPESOR MÁX. A FIJAR		
TCPA24213	4,2 x 13	8,980	PH2	6	500	12.000
TCPA24222	4,2 x 22	17,420	PH2	15	500	12.000
TCPA24232	4,2 x 32	22,313	PH2	25	500	6.000

Tirafondo de alto rendimiento

TEX

INOXIDABLE



CÓDIGO	MEDIDA	€/100			
TEXA250050	5 x 50	27,153	TX25	250	3.000
TEXA250060	5 x 60	32,627	TX25	100	2.400
TEXA250070	5 x 70	36,980	TX25	100	2.400



Blister

CÓDIGO	MEDIDA	€/BOLSA	PCS.	BOLSAS
BZTXA250050	5 x 50	2,565	4	20
BZTXA250060	5 x 60	2,565	4	20
BZTXA250070	5 x 70	2,565	2	20



Caja con Ventana

CÓDIGO	MEDIDA	€/CAJA	PCS.	CAJAS
VTEXA250050	5 x 50	6,988	20	8
VTEXA250060	5 x 60	8,395	20	8
VTEXA250070	5 x 70	9,519	20	8



TEX-A2

Inoxidable A2. Huella TX



Tirafondo con cabeza avellanada inoxidable A2. Huella PZ

TP-A2

INOXIDABLE



CÓDIGO	MEDIDA	€/100			
TPA230016	3 x 16	5,697	PZ1	200	9.000
TPA230025	3 x 25	7,283	PZ1	200	9.000
TPA235020	3,5 x 20	9,610	PZ2	200	9.000
TPA235025	3,5 x 25	10,380	PZ2	200	9.000
TPA235030	3,5 x 30	12,937	PZ2	200	9.000
TPA235040	3,5 x 40	18,390	PZ2	200	4.800
TPA240030	4 x 30	15,720	PZ2	200	9.000
TPA240040	4 x 40	18,563	PZ2	200	4.800
TPA240050	4 x 50	29,137	PZ2	200	4.800
TPA245030	4,5 x 30	18,463	PZ2	200	4.800
TPA245050	4,5 x 50	29,487	PZ2	200	2.400
TPA250050	5 x 50	37,190	PZ2	200	2.400
TPA250070	5 x 70	50,683	PZ2	200	2.400



DIN-571

Tornillo con rosca para madera y aglomerado y cabeza hexagonal

DIN-571 A2

Inoxidable A2



INOXIDABLE



CÓDIGO	MEDIDA	€/100			
•TBA206040	6 x 40	36,067	10	100	2.400
•TBA206050	6 x 50	42,910	10	100	1.200
TBA206060	6 x 60	48,797	10	100	1.200
TBA206070	6 x 70	55,167	10	100	1.200
•TBA208050	8 x 50	80,037	13	100	1.200
•TBA208060	8 x 60	88,080	13	100	1.200
•TBA208070	8 x 70	99,517	13	100	600
TBA208080	8 x 80	111,423	13	100	600
•TBA210080	10 x 80	188,553	17	100	400

• Medidas sin homologar

INV

Tornillo inviolable de huella TX

INV A2

Inoxidable A2



INOXIDABLE



CÓDIGO	MEDIDA	€/100			
•INVA27050	7 x 50	102,340	TX40	100	1.200
•INVA27060	7 x 60	118,637	TX40	100	600
INVA27070	7 x 70	121,547	TX40	100	600
INVA27080	7 x 80	134,197	TX40	100	600

• Medidas sin homologar

INOXIDABLE



DIN-933 A2

Inoxidable A2



CÓDIGO	MEDIDA	€/100			
D933IM04010	M4 x 10	12,083	7	500	12.000
D933IM04016	M4 x 16	14,473	7	500	12.000
D933IM04020	M4 x 20	16,650	7	500	8.000
D933IM04025	M4 x 25	17,960	7	500	8.000
D933IM04030	M4 x 30	20,573	7	500	6.000
D933IM04035	M4 x 35	25,250	7	250	6.000
D933IM04040	M4 x 40	28,077	7	250	6.000
D933IM05010	M5 x 10	12,627	8	500	8.000
D933IM05016	M5 x 16	14,800	8	500	-
D933IM05020	M5 x 20	16,760	8	500	6.000
D933IM05025	M5 x 25	19,263	8	500	4.000
D933IM05030	M5 x 30	22,310	8	500	4.000
D933IM05035	M5 x 35	24,707	8	250	3.000
D933IM05040	M5 x 40	27,753	8	250	3.000
D933IM05050	M5 x 50	33,960	8	250	3.000
D933IM06010	M6 x 10	21,180	10	250	6.000
D933IM06016	M6 x 16	22,437	10	250	4.000
D933IM06020	M6 x 20	25,993	10	250	4.000
D933IM06025	M6 x 25	27,007	10	250	3.000
D933IM06030	M6 x 30	31,380	10	250	3.000
D933IM06035	M6 x 35	35,483	10	250	2.000
D933IM06040	M6 x 40	39,223	10	250	2.000
D933IM06050	M6 x 50	46,547	10	250	1.500
D933IM08016	M8 x 16	41,407	13	200	1.600
D933IM08020	M8 x 20	44,880	13	200	1.600
D933IM08025	M8 x 25	50,663	13	200	1.600
D933IM08030	M8 x 30	56,327	13	200	1.200
D933IM08035	M8 x 35	61,977	13	200	1.200
D933IM08040	M8 x 40	68,413	13	200	1.200
D933IM08050	M8 x 50	82,320	13	200	800
D933IM08060	M8 x 60	93,953	13	200	800
D933IM08070	M8 x 70	112,587	13	200	800
D933IM08080	M8 x 80	128,683	13	100	600
D933IM08090	M8 x 90	142,570	13	100	600
D933IM08100	M8 x 100	159,967	13	100	600
D933IM10020	M10 x 20	84,357	17	200	800
D933IM10025	M10 x 25	88,470	17	200	800
D933IM10030	M10 x 30	96,950	17	200	800
D933IM10035	M10 x 35	105,697	17	200	800

CÓDIGO	MEDIDA	€/100			
D933IM10040	M10 x 40	111,617	17	200	-
D933IM10050	M10 x 50	132,967	17	200	-
D933IM10060	M10 x 60	152,267	17	100	600
D933IM10070	M10 x 70	171,757	17	100	400
D933IM10080	M10 x 80	202,097	17	100	400
D933IM10090	M10 x 90	227,687	17	50	300
D933IM10100	M10 x 100	256,903	17	50	300
D933IM12020	M12 x 20	138,480	19	100	600
D933IM12030	M12 x 30	144,040	19	100	600
D933IM12040	M12 x 40	162,333	19	100	400
D933IM12050	M12 x 50	187,337	19	100	400
D933IM12060	M12 x 60	213,523	19	100	400
D933IM12070	M12 x 70	239,983	19	100	-
D933IM12080	M12 x 80	299,853	19	50	300
D933IM12090	M12 x 90	328,287	19	50	300
D933IM12100	M12 x 100	356,733	19	25	150
D933IM14030	M14 x 30	271,427	22	50	300
D933IM14040	M14 x 40	297,273	22	50	300
D933IM14050	M14 x 50	338,637	22	50	300
D933IM14060	M14 x 60	385,163	22	50	200
D933IM14070	M14 x 70	429,107	22	50	200
D933IM14080	M14 x 80	460,923	22	25	150
D933IM14100	M14 x 100	632,190	22	25	150
D933IM16030	M16 x 30	299,723	24	50	300
D933IM16040	M16 x 40	311,187	24	50	200
D933IM16050	M16 x 50	354,900	24	50	200
D933IM16060	M16 x 60	403,760	24	50	200
D933IM16070	M16 x 70	450,050	24	25	150
D933IM16080	M16 x 80	498,910	24	25	150
D933IM16090	M16 x 90	588,760	24	25	150
D933IM16100	M16 x 100	637,770	24	25	100
D933IM18030	M18 x 30	599,210	27	25	100
D933IM18040	M18 x 40	633,757	27	25	200
D933IM18050	M18 x 50	692,297	27	25	150
D933IM18060	M18 x 60	773,733	27	25	150
D933IM18070	M18 x 70	860,250	27	25	100
D933IM18080	M18 x 80	941,717	27	25	100
D933IM18090	M18 x 90	1.023,167	27	25	100
D933IM18100	M18 x 100	1.104,613	27	25	100



Blister

CÓDIGO	MEDIDA	€/BOLSA	PCS.	BOLSAS
BZ3I04010	M4 x 10	2,565	6	20
BZ3I04016	M4 x 16	2,565	6	20
BZ3I04020	M4 x 20	2,565	6	20
BZ3I04030	M4 x 30	2,565	6	20
BZ3I04040	M4 x 40	2,565	6	20
BZ3I05010	M5 x 10	2,565	6	20
BZ3I05016	M5 x 16	2,565	6	20
BZ3I05020	M5 x 20	2,565	6	20
BZ3I05025	M5 x 25	2,277	6	20
BZ3I05030	M5 x 30	2,565	6	20
BZ3I05040	M5 x 40	2,565	6	20
BZ3I05050	M5 x 50	2,565	6	20
BZ3I06016	M6 x 16	2,565	6	20
BZ3I06020	M6 x 20	2,565	6	20
BZ3I06025	M6 x 25	2,565	6	20
BZ3I06030	M6 x 30	2,565	6	20
BZ3I06040	M6 x 40	2,565	6	20
BZ3I06050	M6 x 50	2,565	6	20
BZ3I08016	M8 x 16	2,565	4	20
BZ3I08020	M8 x 20	2,565	4	20
BZ3I08025	M8 x 25	2,565	4	20
BZ3I08030	M8 x 30	2,565	4	20
BZ3I08040	M8 x 40	2,565	4	20
BZ3I08050	M8 x 50	2,565	4	20
BZ3I08060	M8 x 60	2,565	4	20
BZ3I10020	M10 x 20	2,565	2	20
BZ3I10030	M10 x 30	2,565	2	20
BZ3I10040	M10 x 40	2,565	2	20



Caja con Ventana

CÓDIGO	MEDIDA	€/CAJA	PCS.	CAJAS
VD933I04010	M4 x 10	5,951	40	8
VD933I04016	M4 x 16	7,130	40	8
VD933I04020	M4 x 20	7,905	40	8
VD933I04030	M4 x 30	7,601	30	8
VD933I04040	M4 x 40	8,328	25	8
VD933I05010	M5 x 10	6,222	40	8
VD933I05016	M5 x 16	7,294	40	8
VD933I05020	M5 x 20	8,258	40	8
VD933I05030	M5 x 30	5,495	20	8
VD933I05040	M5 x 40	6,838	20	8
VD933I05050	M5 x 50	4,390	10	8
VD933I06010	M6 x 10	7,828	30	8
VD933I06016	M6 x 16	7,983	30	8
VD933I06020	M6 x 20	9,251	30	8
VD933I06025	M6 x 25	8,009	25	8
VD933I06030	M6 x 30	9,307	25	8
VD933I06040	M6 x 40	7,249	15	8
VD933I06050	M6 x 50	5,733	10	8
VD933I08016	M8 x 16	10,201	20	8
VD933I08020	M8 x 20	11,054	20	8
VD933I08025	M8 x 25	12,481	20	8
VD933I08030	M8 x 30	10,408	15	8
VD933I08040	M8 x 40	8,428	10	8
VD933I08050	M8 x 50	10,138	10	8
VD933I08060	M8 x 60	11,573	10	8
VD933I10020	M10 x 20	10,390	10	8
VD933I10030	M10 x 30	11,943	10	8
VD933I10040	M10 x 40	13,749	10	8
VD933I10050	M10 x 50	16,378	10	8
VD933I10060	M10 x 60	18,755	10	8

ISF-CC

Conectores + Complementos para montaje de estructuras solares

NEW DIN-6921 A2

Tornillo DIN-6921. Tornillo hexagonal con arandela estampada y grafilada. Inoxidable A2



METAL



CÓDIGO	MEDIDA	€/100	LLAVE DE INSTALACIÓN		
6921108020	M8 x 20	46,040	13	200	2.400
6921108050	M8 x 50	87,807	13	100	600
6921108070	M8 x 70	112,967	13	100	600

NEW DIN-603 A2

Tornillo DIN-603. Cabeza redonda y cuello cuadrado. Inoxidable A2



METAL



CÓDIGO	MEDIDA	€/100		
D603I08016	M8 x 16	42,047	200	2.400

DIN-934

Tuerca hexagonal

DIN-934 A2

Inoxidable A2



INOXIDABLE



CÓDIGO	MEDIDA	€/100	LLAVE DE INSTALACIÓN		
D934IM04	M4	4,447	7	500	22.500
D934IM05	M5	5,140	8	500	12.000
D934IM06	M6	8,483	10	500	12.000
D934IM08	M8	17,207	13	250	4.000
D934IM10	M10	38,387	17	250	2.000
D934IM12	M12	56,280	19	250	1.500
D934IM14	M14	80,893	22	100	800
D934IM16	M16	113,520	24	100	600
D934IM18	M18	180,550	27	100	600
D934IM20	M20	237,070	30	50	400
D934IM22	M22	327,683	32	50	300
D934IM24	M24	425,983	36	25	200



Blister



Caja con Ventana

CÓDIGO	MEDIDA	€/BOLSA	PCS.	BOLSAS
BZ934IM04	M4	2,565	10	20
BZ934IM05	M5	2,565	8	20
BZ934IM06	M6	2,565	8	20
BZ934IM08	M8	2,565	6	20
BZ934IM10	M10	2,565	5	15

CÓDIGO	MEDIDA	€/CAJA	PCS.	CAJAS
VD934IM04	M4	3,274	50	8
VD934IM05	M5	3,786	50	8
VD934IM06	M6	5,621	50	8
VD934IM08	M8	6,841	30	8
VD934IM10	M10	10,175	20	8

Tuerca autoblocante

DIN-985

INOXIDABLE



DIN-985 A2

Inoxidable A2



CÓDIGO	MEDIDA	€/100	LLAVE DE INSTALACIÓN		
D985IM04	M4	8,233	7	500	8.000
D985IM05	M5	8,867	8	500	8.000
D985IM06	M6	12,527	10	500	8.000
D985IM08	M8	24,697	13	250	4.000
D985IM10	M10	52,593	17	250	2.000
D985IM12	M12	81,753	19	100	1.200
D985IM14	M14	146,147	22	100	800
D985IM16	M16	177,133	24	50	600
D985IM18	M18	405,373	27	50	400
D985IM20	M20	519,897	30	25	300
D985IM22	M22	1.176,747	32	25	300
D985IM24	M24	1.586,600	36	25	150



Blister



Caja con Ventana

CÓDIGO	MEDIDA	€/BOLSA	PCS.	BOLSAS
BZ985IM04	M4	2,565	10	20
BZ985IM05	M5	2,565	8	20
BZ985IM06	M6	2,565	8	20
BZ985IM08	M8	2,565	6	20
BZ985IM10	M10	2,565	5	15

CÓDIGO	MEDIDA	€/CAJA	PCS.	CAJAS
VD985IM04	M4	5,454	50	8
VD985IM05	M5	5,877	50	8
VD985IM06	M6	8,302	50	8
VD985IM08	M8	9,819	30	8
VD985IM10	M10	13,942	20	8

Conectores + Complementos para montaje de estructuras solares

ISF-CC

METAL



DIN-6923 A2

NEW

Tuerca brida grafilada DIN-6923.
Inoxidable A2



CÓDIGO	MEDIDA	€/100	LLAVE DE INSTALACIÓN		
D6923IM08	M8	22,833	13	250	3.000
D6923IM10	M10	38,510	15	250	3.000
D6923IM12	M12	65,500	18	250	1.500

Arandela plana

DIN-125

INOXIDABLE



DIN-125 A2

Inoxidable A2



CÓDIGO	MEDIDA	€/100		
D125IM04	M4	1,323	500	22.500
D125IM05	M5	1,750	500	22.500
D125IM06	M6	3,170	500	22.500
D125IM08	M8	5,437	250	11.250
D125IM10	M10	10,387	250	6.000
D125IM12	M12	18,477	250	3.000
D125IM14	M14	28,960	200	2.400
D125IM16	M16	31,977	100	2.400
D125IM18	M18	47,420	100	1.600
D125IM20	M20	50,357	50	1.200
D125IM22	M22	59,713	50	1.200
D125IM24	M24	104,480	50	600



Blister



Caja con Ventana

CÓDIGO	MEDIDA	€/BOLSA	PCS.	BOLSAS
BZ125IM04	M4	2,565	10	20
BZ125IM05	M5	2,565	8	20
BZ125IM06	M6	2,565	8	20
BZ125IM08	M8	2,565	6	20
BZ125IM10	M10	2,565	5	20

CÓDIGO	MEDIDA	€/CAJA	PCS.	CAJAS
VD125IM04	M4	3,241	100	8
VD125IM05	M5	3,252	75	8
VD125IM06	M6	4,108	75	8
VD125IM08	M8	4,283	50	8
VD125IM10	M10	7,142	50	8

DIN-9021

Arandela plana ancha

DIN-9021 A2

Inoxidable A2



INOXIDABLE



CÓDIGO	MEDIDA	€/100		
D9021IM04	M4	2,380	500	22.500
D9021IM05	M5	4,357	500	12.000
D9021IM06	M6	7,893	500	8.000
D9021IM08	M8	15,560	200	4.800
D9021IM10	M10	35,207	100	1.600
D9021IM12	M12	60,720	100	800
D9021IM14	M14	131,004	100	800
D9021IM16	M16	132,610	50	600
D9021IM18	M18	237,443	50	400
D9021IM20	M20	266,213	25	300
D9021IM22	M22	274,243	25	200
D9021IM24	M24	315,377	25	150



Blister

CÓDIGO	MEDIDA	€/BOLSA	PCS. 	BOLSAS
BZ9021IM04	M4	2,565	10	20
BZ9021IM05	M5	2,565	8	20
BZ9021IM06	M6	2,565	8	20
BZ9021IM08	M8	2,565	6	20
BZ9021IM10	M10	2,565	5	20



Caja con Ventana

CÓDIGO	MEDIDA	€/CAJA	PCS. 	CAJAS
VD9021IM04	M4	3,508	100	8
VD9021IM05	M5	4,331	75	8
VD9021IM06	M6	7,846	75	8
VD9021IM08	M8	8,250	40	8
VD9021IM10	M10	9,333	20	8

ISF-CC

Conectores + Complementos para montaje de estructuras solares

NEW

DIN-127 A2

Arandela muelle grower DIN-127.
Inoxidable A2



METAL



CÓDIGO	MEDIDA	€/100		
D127IM08	M8	4,530	200	9.000
D127IM10	M10	7,237	100	4.500
D127IM12	M12	10,923	100	4.500

Abrazadera reforzada M8 + M10
Abrazadera reforzada M8 + M10. Inoxidable A2

AB-RE A2

INOXIDABLE



CÓDIGO	MEDIDA	€/100	MEDIDA EN PULGADAS	ØD(MM)	CARGA MÁXIMA		
ABREA2018	18 (M8+M10)	350,963	3/8"	15 - 18	150	50	300
ABREA2022	22 (M8+M10)	369,093	1/2"	20 - 24	150	50	200
ABREA2028	28 (M8+M10)	405,210	3/4"	26 - 30	150	50	150
ABREA2035	35 (M8+M10)	423,987	1"	32 - 36	150	50	100
ABREA2040	40 (M8+M10)	448,793	1 1/4"	36 - 42	150	25	100
ABREA2048	48 (M8+M10)	473,157	1 1/2"	47 - 50	150	25	100
ABREA2054	54 (M8+M10)	499,703	-	51 - 55	150	25	75
ABREA2060	60 (M8+M10)	531,453	2"	60 - 64	150	25	75
ABREA2075	75 (M8+M10)	601,983	2 1/2"	75 - 80	150	25	50
ABREA2090	90 (M8+M10)	692,637	3"	87 - 92	150	25	-
ABREA2110	110 (M8+M10)	749,337	-	106 - 112	150	25	-
ABREA2115	115 (M8+M10)	781,637	4"	114 - 119	150	25	-
ABREA2125	125 (M8+M10)	838,380	4 1/2"	124 - 131	150	25	-
ABREA2140	140 (M8+M10)	926,653	5"	133 - 140	150	25	-
ABREA2160	160 (M8+M10)	1.057,567	6"	159 - 163	150	25	-
ABREA2200	200 (M8+M10)	1.475,183	-	199 - 212	150	25	-



02 Info
P. 3/8 Técnica

REFORZADA

M8 + M10



Abrazadera reforzada M8 + M10

AB-RE A4

INOXIDABLE



CÓDIGO	MEDIDA	€/100	MEDIDA EN PULGADAS	ØD(MM)	CARGA MÁXIMA		
ABREA4018	18 (M8+M10)	449,050	3/8"	15 - 18	150	50	300
ABREA4022	22 (M8+M10)	474,767	1/2"	20 - 24	150	50	200
ABREA4028	28 (M8+M10)	507,057	3/4"	26 - 30	150	50	150
ABREA4035	35 (M8+M10)	529,697	1"	32 - 36	150	50	100
ABREA4040	40 (M8+M10)	568,197	1 1/4"	36 - 42	150	25	100
ABREA4048	48 (M8+M10)	613,867	1 1/2"	47 - 50	150	25	100
ABREA4054	54 (M8+M10)	640,433	-	51 - 55	150	25	75
ABREA4060	60 (M8+M10)	682,693	2"	60 - 64	150	25	75
ABREA4075	75 (M8+M10)	757,447	2 1/2"	75 - 80	150	25	50
ABREA4090	90 (M8+M10)	830,587	3"	87 - 92	150	25	-
ABREA4110	110 (M8+M10)	956,430	-	106 - 112	150	25	-
ABREA4115	115 (M8+M10)	1.026,100	4"	114 - 119	150	25	-
ABREA4125	125 (M8+M10)	1.081,013	4 1/2"	124 - 131	150	25	-
ABREA4140	140 (M8+M10)	1.279,617	5"	133 - 140	150	25	-
ABREA4160	160 (M8+M10)	1.404,623	-	159 - 163	150	25	-
ABREA4200	200 (M8+M10)	1.704,457	-	199 - 212	150	25	-



02 Info
P. 3/8 Técnica

REFORZADA

M8 + M10



AB-RI A2

Abrazadera isofónica reforzada M8 + M10



02 Info
Técnica
P. 378

CTE
CÓDIGO TÉCNICO
DE LA EDIFICACIÓN

REFORZADA
R

M8 + M10



INOXIDABLE



CÓDIGO	MEDIDA	€/100	MEDIDA EN PULGADAS	ØD(MM)	CARGA MÁXIMA		
ABRIA2018	18 (M8+M10)	452,633	3/8"	15 - 18	150	50	200
ABRIA2022	22 (M8+M10)	465,123	1/2"	20 - 24	150	50	150
ABRIA2028	28 (M8+M10)	485,820	3/4"	26 - 30	150	50	150
ABRIA2035	35 (M8+M10)	511,127	1"	32 - 36	150	50	100
ABRIA2040	40 (M8+M10)	538,987	1 1/4"	36 - 42	150	25	75
ABRIA2048	48 (M8+M10)	571,240	1 1/2"	47 - 50	150	25	75
ABRIA2054	54 (M8+M10)	623,673	-	51 - 55	150	25	50
ABRIA2060	60 (M8+M10)	657,530	2"	60 - 64	150	25	50
ABRIA2075	75 (M8+M10)	740,760	2 1/2"	75 - 80	150	25	-
ABRIA2090	90 (M8+M10)	800,907	3"	87 - 92	150	25	-
ABRIA2110	110 (M8+M10)	890,610	-	106 - 112	150	25	-
ABRIA2115	115 (M8+M10)	915,293	4"	114 - 119	150	25	-
ABRIA2125	125 (M8+M10)	986,493	4 1/2"	124 - 131	150	25	-
ABRIA2140	140 (M8+M10)	1.021,377	5"	133 - 140	150	25	-
ABRIA2160	160 (M8+M10)	1.145,937	6"	159 - 163	150	25	-

AB-RI A4

Abrazadera isofónica reforzada M8 + M10



02 Info
Técnica
P. 378

CTE
CÓDIGO TÉCNICO
DE LA EDIFICACIÓN

REFORZADA
R

M8 + M10



INOXIDABLE



CÓDIGO	MEDIDA	€/100	MEDIDA EN PULGADAS	ØD(MM)	CARGA MÁXIMA		
ABRIA4018	18 (M8+M10)	536,790	3/8"	15 - 18	150	50	200
ABRIA4022	22 (M8+M10)	564,327	1/2"	20 - 24	150	50	150
ABRIA4028	28 (M8+M10)	589,053	3/4"	26 - 30	150	50	150
ABRIA4035	35 (M8+M10)	633,163	1"	32 - 36	150	50	100
ABRIA4040	40 (M8+M10)	682,457	1 1/4"	36 - 42	150	25	75
ABRIA4048	48 (M8+M10)	733,720	1 1/2"	47 - 50	150	25	75
ABRIA4054	54 (M8+M10)	770,017	-	51 - 55	150	25	50
ABRIA4060	60 (M8+M10)	841,693	2"	60 - 64	150	25	50
ABRIA4075	75 (M8+M10)	920,903	2 1/2"	75 - 80	150	25	-
ABRIA4090	90 (M8+M10)	1.010,433	3"	87 - 92	150	25	-
ABRIA4110	110 (M8+M10)	1.191,347	-	106 - 112	150	25	-
ABRIA4115	115 (M8+M10)	1.238,547	4"	114 - 119	150	25	-
ABRIA4125	125 (M8+M10)	1.312,093	4 1/2"	124 - 131	150	25	-
ABRIA4140	140 (M8+M10)	1.422,880	5"	133 - 140	150	25	-
ABRIA4160	160 (M8+M10)	1.630,030	6"	159 - 163	150	25	-



AB-ZI A2

Inoxidable A2



CÓDIGO	MEDIDA	€/100	Ø VARILLA PULGADAS	CARGA MÁXIMA		
AZA2060500	M6 1/2"	105,883	1/2"	250	100	600
AZA2060750	M6 3/4"	123,093	3/4"	250	100	600
AZA2061000	M6 1"	151,650	1"	250	100	400
AZA2061250	M6 1 1/4"	179,560	1 1/4"	250	50	300
AZA2081500	M8 1 1/2"	312,037	1 1/2"	350	50	150
AZA2082000	M8 2"	362,937	2"	350	50	150
AZA2082500	M8 2 1/2"	408,927	2 1/2"	350	50	100
AZA2083000	M8 3"	444,473	3"	350	50	100
AZA2104000	M10 4"	904,320	4"	350	50	-
AZA2106000	M10 6"	1.166,313	6"	350	25	-
AZA2108000	M10 8"	1.395,300	8"	350	25	-

Abrazadera inoxidable Indextube

AB-IT

SANEAMIENTO



AB-ITS NEW

Simple



CÓDIGO	MEDIDA	€/100		
ABITS015	Ø15	122,600	100	600
ABITS018	Ø18	132,847	100	400
ABITS022	Ø22	196,913	100	400
ABITS028	Ø28	264,693	100	300

SANEAMIENTO



AB-ITD NEW

Doble



CÓDIGO	MEDIDA	€/100		
ABITD015	Ø15	453,273	50	300
ABITD018	Ø18	513,180	50	200
ABITD022	Ø22	201,960	50	100

Abrazadera M6

AB-M6 A2

INOXIDABLE



02
P. 397
Info
Técnica

CÓDIGO	MEDIDA	€/100	MEDIDA EN PULGADAS	ØD(MM)	CARGA MÁXIMA		
ABM6A2012	12 (M6)	198,680	1/4"	12	70	100	1.200
ABM6A2015	15 (M6)	202,270	-	14 - 15	70	100	600
ABM6A2018	18 (M6)	205,860	3 / 8"	16 - 18	70	100	600
ABM6A2020	20 (M6)	209,980	1 / 2"	19 - 21	70	100	600
ABM6A2022	22 (M6)	212,633	-	22 - 24	70	100	600
ABM6A2028	28 (M6)	224,573	3/4"	25 - 30	70	100	400

AB-SF A2

Abrazadera sin fin



02 Info
P. 403 Técnica

Arandela estampada

Para varios Ø



INOXIDABLE



CÓDIGO	MEDIDA	€/100	MEDIDA EN PULGADAS		
ASF2010016	10-16	91,983	-	100	1.200
ASF2012020	12-20	94,273	1/2" - 7/8"	100	600
ASF2016027	16-27	98,337	5/8" - 1 1/16"	100	600
ASF2020032	20-32	110,910	3/4" - 1 1/4"	100	600
ASF2025040	25-40	121,187	1" - 1 5/8"	100	200
ASF2032050	32-50	168,677	1 3/8" - 2"	100	300
ASF2040060	40-60	179,097	1 5/8" - 2 3/8"	100	200
ASF2050070	50-70	186,910	2" - 2 3/4"	50	100
ASF2060080	60-80	196,483	2 3/8" - 3 1/8"	50	100
ASF2070090	70-90	206,930	2 3/4" - 3 1/2"	50	100
ASF2080100	80-100	213,867	3 1/8" - 4"	50	100
ASF2090110	90-110	249,403	3 1/2" - 4 3/8"	50	50
ASF2100120	100-120	259,197	4" - 4 3/4"	25	25
ASF2110130	110-130	268,960	4 3/8" - 5 1/8"	25	25
ASF2120140	120-140	282,660	4 3/4" - 5 1/2"	25	25
ASF2130150	130-150	293,423	5 1/8" - 5 7/8"	25	25

AB-SF IR

Abrazadera sin fin inoxidable en rollo

AB-SF IR

Kit



CÓDIGO	MEDIDA	€/PC		
ASFIR03	9 x 0,6 mm/ 3 m	1.429,560	1	50

AB-SF IRC

Cabezal



CÓDIGO	MEDIDA	€/100		
ASFIRCA	Cabezal	102,113	50	1.000

AB-SF IRR

30 metros



CÓDIGO	MEDIDA	€/PC		
ASFIR30	9 x 0,6 mm/ 30 m	5.105,580	1	10

CI-PE

Cinta perforada

CI-PE A2

Inoxidable A2



INOXIDABLE



CÓDIGO	MEDIDA	€/PC	UD. MIN. VENTA		
CIPEA21708	17 x 0,8 x 10 m	40,304	1	1	30



Soportes de fijación para sanitarios

SA



CÓDIGO	MEDIDA	€/KIT	KITS X
SAIL06080	M6 x 80	3,017	100

2 PCS x KIT

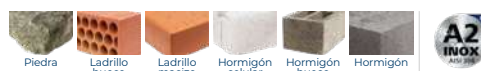

CÓDIGO	MEDIDA	€/KIT	KITS X
SACI06080	M6 x 80	5,727	100

TAMBIÉN DISPONIBLE EN
easykits

SA-IL

Fijación de WC y bidé con taco largo



SA-CI

Fijación de cisterna



2 PCS x KIT

Perfiles para cargas ligeras tipo "C"

GP

INOXIDABLE

A2 inox

CÓDIGO	MEDIDA	€/100	LONGITUD	
GPI271812	27 x 18 x 1,25 x 2.000	12.032,189	2.000	6
GPI283015	28 x 30 x 1,50 x 2.000	27.975,448	2.000	6

GP-A2

Guía perforada inoxidable A2



Accesorios para perfiles tipo "C"

EG

INOXIDABLE

A2 inox

CÓDIGO	MEDIDA	€/100	VÁLIDO PARA		
EMI45	50 x 50 45°	617,260	27/18 - 28/30 - 38/40	50	200
EMI90	54 x 54 90°	617,260	27/18 - 28/30 - 38/40	50	-
EMI00	100 180°	611,967	27/18 - 28/30 - 38/40	50	200

EG-A2

Escuadra inoxidable A2



PG

Accesorios para perfiles tipo "C"

PG-A2

Puente guía inoxidable A2



INOXIDABLE



CÓDIGO	MEDIDA	€/100	VÁLIDO PARA		
PGI2718	27 / 18 x 81	301,077	27/18	50	300
PGI2830	28 / 30 x 81	346,240	28/30	50	200
PGI3840	38 / 40 x 93	421,507	38/40	50	100

RV

Varilla roscada

RV-A2

Inoxidable A2



INOXIDABLE



CÓDIGO	MEDIDA	€/100	PASO	
975A2M04	M4 x 1.000	380,780	0,7	1
975A2M05	M5 x 1.000	449,000	0,8	1
975A2M06	M6 x 1.000	619,920	1	1
975A2M08	M8 x 1.000	1.006,010	1,25	1
975A2M10	M10 x 1.000	1.457,350	1,5	1
975A2M12	M12 x 1.000	2.218,653	1,75	1
975A2M14	M14 x 1.000	3.885,137	2	1
975A2M16	M16 x 1.000	4.486,253	2	1
975A2M18	M18 x 1.000	4.894,093	2,5	1
975A2M20	M20 x 1.000	6.753,847	2,5	1
975A2M22	M22 x 1.000	7.894,990	2,5	1
975A2M24	M24 x 1.000	10.657,117	3	1
975A2M27	M27 x 1.000	12.844,027	3	1
975A2M30	M30 x 1.000	19.989,633	3,5	1
975A2M33	M33 x 1.000	25.095,807	3,5	1
975A2M36	M36 x 1.000	28.864,247	4	1

MA

Manguito de unión

MARI

De unión. Redondo. Inoxidable A2



INOXIDABLE



CÓDIGO	MEDIDA	€/100	LONGITUD	
MARI0830	M8 x 30	207,170	30	100
MARI1030	M10 x 30	285,210	30	100

AB-TA

Tirafondo abrazadera y grapa

AB-TA A2

Inoxidable A2. Ranurado



INOXIDABLE



CÓDIGO	MEDIDA	€/100		
ABTA20630	M6 x 30	78,334	100	2.400

Espárrago de doble rosca

ES-DR

INOXIDABLE



CÓDIGO	MEDIDA	€/100		
ESDA208060	M8 x 60	115,807	100	800
ESDA210060	M10 x 60	215,433	100	800

ES-DA2

Inoxidable A2. Tx



02
P. 413
Info.
Técnica

Remaches

RE

METAL



CÓDIGO	MEDIDA	€/100	Ø BROCA	ESPESOR MÁX. A FIJAR		
REIN3206	3,2 x 6,4	19,440	3,3	0,5 – 3	500	6.000
REIN3208	3,2 x 8	20,797	3,3	3 – 5	500	6.000
REIN3212	3,2 x 12,7	30,647	3,3	6,5 – 8,5	500	6.000
REIN3215	3,2 x 15,9	37,027	3,3	10,5 – 12,5	500	6.000
REIN4008	4 x 8,5	34,910	4,1	2,5 – 4,5	500	6.000
REIN4010	4 x 10,2	37,150	4,1	4,5 – 6,5	500	6.000
REIN4012	4 x 12	42,103	4,1	6,5 – 8,5	500	6.000
REIN4016	4 x 16	50,977	4,1	10 – 12	500	3.000
REIN4810	4,8 x 10,8	51,360	5	4 – 6	500	3.000
REIN4812	4,8 x 12	56,140	5	6 – 8	500	3.000
REIN4816	4,8 x 16	69,020	5	8 – 11	250	3.000
REIN4820	4,8 x 20,3	96,840	5	11 – 13	250	3.000
REIN4818	4,8 x 18	73,797	5	13 – 15	250	3.000

RE-IN

Cabeza alomada. Acero inoxidable A2



Pletina de fijación

PF

INOXIDABLE



CÓDIGO	MEDIDA	€/100		
PFA4M0800	M8	303,137	100	600
PFA4M0810	M8 + M10	361,303	100	600
PFA4M1000	M10	346,320	100	600

PF-A4

Inoxidable A4



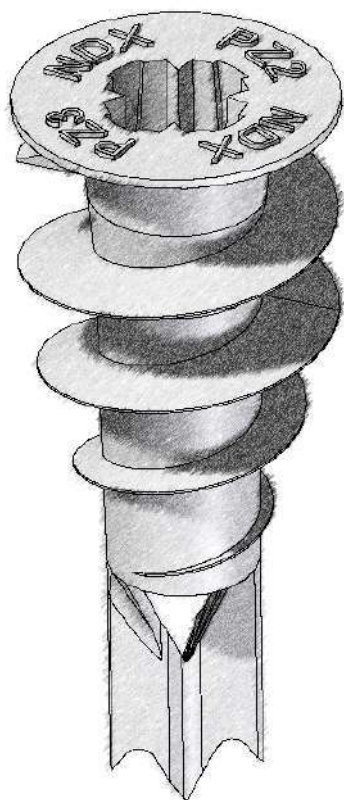
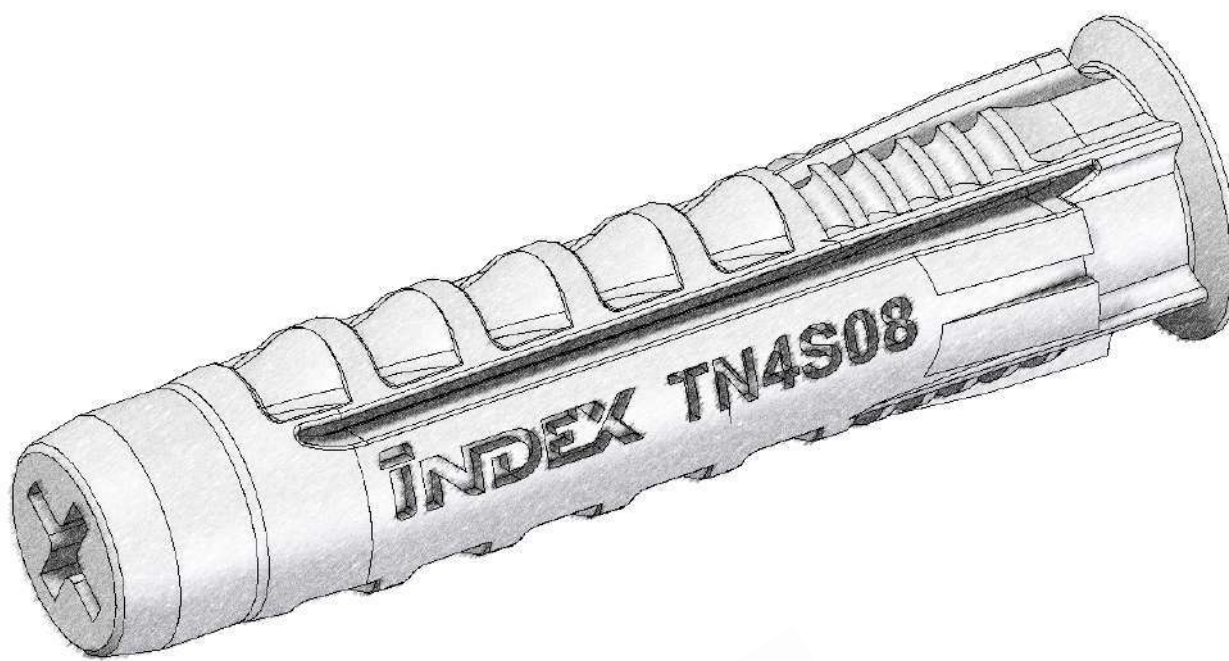

CARACTERÍSTICAS TÉCNICAS

PARÁMETROS TÉCNICOS DE INSTALACIÓN

En las siguientes páginas encontrarás una serie de datos de consulta rápida que te ayudarán a elegir el producto adecuado para tu instalación. Si deseas ampliar esta información puedes consultar nuestra documentación técnica en: www.indexfix.com

Los datos que primero encontrarás son de carácter descriptivo y nos ayudan a entender la geometría del anclaje y su código de referencia correspondiente. Los siguientes son parámetros de instalación del producto, utilizando como unidades de distancia los mm, kg para las cargas máximas recomendadas y Nm para el par de apriete de los anclajes.

La mayoría de productos vienen acompañados de un croquis acotado, el significado de estas cotas para los anclajes se describe a continuación:

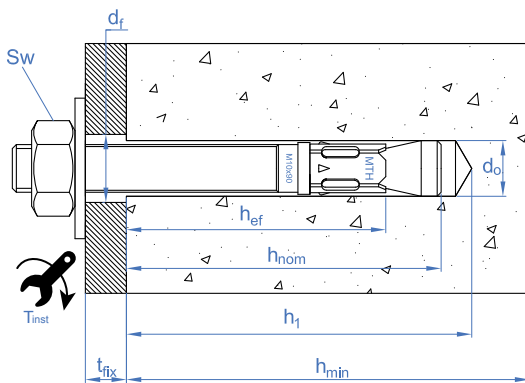

d_o	diámetro de broca o diámetro del taladro [mm]
h_1	profundidad mínima del taladro o agujero [mm]
h_{min}	espesor mínimo del material base [mm]
d_f	diámetro del agujero del elemento a fijar [mm]
h_{nom}	profundidad de instalación del anclaje [mm]
t_{fix}	espesor máximo a fijar [mm]
t_{inst}	par de apriete necesario para la correcta expansión del anclaje [Nm]
C_{cr}	distancia crítica al borde [mm]
S_c	distancia crítica entre anclajes [mm]
h_{ef}	profundidad efectiva del anclaje [mm]
SW	llave de instalación o distancia entre caras de la tuerca [mm]

EXTRACCIÓN

Carga máxima recomendada a tracción que puede resistir el anclaje. Ésta ha sido calculada aplicando un factor de seguridad 1.4 a la resistencia de cálculo del anclaje y está expresada en kg. Este factor aplica para hormigón fisurado y no fisurado. Para otros materiales el factor de seguridad puede llegar hasta 2.5.

CIZALLADURA

Carga máxima recomendada a cortante que puede resistir el anclaje. Ésta ha sido calculada aplicando un factor de seguridad 1.4 a la resistencia de cálculo del anclaje y está expresada en kg. Este factor aplica para hormigón fisurado y no fisurado. Para otros materiales el factor de seguridad puede llegar hasta 2.5.

MTP

Anclaje macho para cargas altas en hormigón fisurado y no fisurado

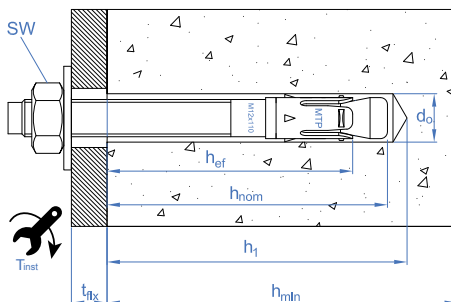

MTP

Homologado ETE Opt.1. Eje cincado. Clip Inoxidable A4

CÓDIGO	MXL	ESPOSOR MÁX. A FIJAR	Ø BROCA	PROFUNDIDAD MÍN. DE TALADRO	PROFUNDIDAD MÍN. DEL ANCLAJE	LLAVE DE INSTALACIÓN	PAR DE APRIETE (NM)	LETRA EJE	Ø ELEMENTO A FIJAR	MÍN. ESPESOR MATERIAL BASE	DISTANCIA MÍN. AL BORDE "A"	DISTANCIA MÍN. ENTRE EJES "B"	EXTRACCIÓN HORMIGÓN NO-FISURADO	CIZALLADURA HORMIGÓN NO-FISURADO	EXTRACCIÓN HORMIGÓN FISURADO	CIZALLADURA HORMIGÓN FISURADO
AP08050	M8 x 50	2	8	40	37	13	20	A	9	100	72	144	182	392	130	275
AP08075	M8 x 75	9	8	60	55	13	20	C	9	100	72	144	364	641	202	556
AP08095	M8 x 95	29	8	60	55	13	20	E	9	100	72	144	364	641	202	556
AP08115	M8 x 115	49	8	60	55	13	20	G	9	100	72	144	364	641	202	556
AP10090	M10 x 90	10	10	75	68	17	40	E	12	120	90	180	777	1014	437	1014
AP10105	M10 x 105	25	10	75	68	17	40	F	12	120	90	180	777	1014	437	1014
AP10115	M10 x 115	35	10	75	68	17	40	G	12	120	90	180	777	1014	437	1014
AP10135	M10 x 135	55	10	75	68	17	40	H	12	120	90	180	777	1014	437	1014
AP10165	M10 x 165	85	10	75	68	17	40	K	12	120	90	180	777	1014	437	1014
AP10185	M10 x 185	105	10	75	68	17	40	L	12	120	90	180	777	1014	437	1014
AP12080	M12 x 80	4	12	85	80	19	60	D	14	140	105	210	971	1474	582	1474
AP12100	M12 x 100	4	12	85	80	19	60	E	14	140	105	210	971	1474	582	1474
AP12110	M12 x 110	14	12	85	80	19	60	F	14	140	105	210	971	1474	582	1474
AP12120	M12 x 120	24	12	85	80	19	60	G	14	140	105	210	971	1474	582	1474
AP12130	M12 x 130	34	12	85	80	19	60	H	14	140	105	210	971	1474	582	1474
AP12150	M12 x 150	54	12	85	80	19	60	I	14	140	105	210	971	1474	582	1474
AP12180	M12 x 180	84	12	85	80	19	60	L	14	140	105	210	971	1474	582	1474
AP12200	M12 x 200	104	12	85	80	19	60	M	14	140	105	210	971	1474	582	1474
AP16145	M16 x 145	28	16	105	97	24	100	I	18	170	128	255	1699	2744	1214	2620
AP16175	M16 x 175	58	16	105	97	24	100	K	18	170	128	255	1699	2744	1214	2620
AP16220	M16 x 220	103	16	105	97	24	100	O	18	170	128	255	1699	2744	1214	2620
AP16250	M16 x 250	133	16	105	97	24	100	Q	18	170	128	255	1699	2744	1214	2620
AP20170	M20 x 170	32	20	125	114	30	200	K	22	200	150	300	2388	4258	1456	3343
AP20200	M20 x 200	62	20	125	114	30	200	N	22	200	150	300	2388	4258	1456	3343
AP24205	M24 x 205	35	24	155	143	36	250	N	26	250	188	375	2023	4934	1214	4672
AP24235	M24 x 235	65	24	155	143	36	250	P	26	250	188	375	2023	4934	1214	4672

MTP-A4

Homologado ETE Opt.1. Eje Inoxidable A4. Clip Inoxidable A4

CÓDIGO	MXL	ESPOSOR MÁX. A FIJAR	Ø BROCA	PROFUNDIDAD MÍN. DE TALADRO	PROFUNDIDAD MÍN. DEL ANCLAJE	LLAVE DE INSTALACIÓN	PAR DE APRIETE (NM)	LETRA EJE	Ø ELEMENTO A FIJAR	MÍN. ESPESOR MATERIAL BASE	DISTANCIA MÍN. AL BORDE "A"	DISTANCIA MÍN. ENTRE EJES "B"	EXTRACCIÓN HORMIGÓN NO-FISURADO	CIZALLADURA HORMIGÓN NO-FISURADO	EXTRACCIÓN HORMIGÓN FISURADO	CIZALLADURA HORMIGÓN FISURADO
APA408075	M8 x 75	9	8	60	55	13	15	C	9	100	144	72	582	693	413	556
APA408095	M8 x 95	29	8	60	55	13	15	E	9	100	144	72	582	693	413	556
APA408115	M8 x 115	49	8	60	55	13	15	G	9	100	144	72	582	693	413	556
APA408135	M8 x 135	69	8	60	55	13	15	H	9	100	144	72	582	693	413	556
APA410090	M10 x 90	10	10	75	68	17	30	E	12	120	180	90	777	1101	413	556
APA410105	M10 x 105	25	10	75	68	17	30	F	12	120	180	90	777	1101	413	556
APA410115	M10 x 115	35	10	75	68	17	30	G	12	120	180	90	777	1101	680	1101
APA410135	M10 x 135	55	10	75	68	17	30	H	12	120	180	90	777	1101	680	1101
APA410165	M10 x 165	85	10	75	68	17	30	K	12	120	180	90	777	1101	680	1101
APA410185	M10 x 185	105	10	75	68	17	30	L	12	120	180	90	777	1101	680	1101
APA412110	M12 x 110	14	12	85	80	19	60	F	14	140	210	105	890	1596	769	1596
APA412120	M12 x 120	24	12	85	80	19	60	G	14	140	210	105	890	1596	769	1596
APA412130	M12 x 130	34	12	85	80	19	60	H	14	140	210	105	890	1596	769	1596
APA412150	M12 x 150	54	12	85	80	19	60	I	14	140	210	105	890	1596	769	1596
APA412180	M12 x 180	84	12	85	80	19	60	L	14	140	210	105	890	1596	769	1596
APA412200	M12 x 200	104	12	85	80	19	60	M	14	140	210	105	890	1596	769	1596
APA416125	M16 x 125	8	16	105	97	24	100	G	18	170	255	128	890	1596	769	1596
APA416145	M16 x 145	28	16	105	97	24	100	I	18	170	255	128	1559	3204	1092	2620
APA416175	M16 x 175	58	16	105	97	24	100	K	18	170	255	128	1559	3204	1092	2620
APA416190	M16 x 190	73	16	105	97	24	100	L	18	170	255	128	1559	3204	1092	2620
APA416220	M16 x 220	103	16	105	97	24	100	O	18	170	255	128	1559	3204	1092	2620
APA420200	M20 x 200	62	20	125	114	30	200	M	22	200	300	150	1990	4776	1393	3343
APA420240	M20 x 240	102	20	125	114	30	200	P	22	200	300	150	1990	4776	1393	3343
APA420285	M20 x 285	147	20	125	114	30	200	S	22	200	300	150	1990	4776	1393	3343

MTP-X

Homologado ETE Opt.1. Eje Cincado. Clip ATLANTIS C3-L

CÓDIGO	MXL	ESPEJOR MÁX. A FIJAR	Ø BROCA	PROFUNDIDAD MÍN. DE TALADRO	PROFUNDIDAD MÍN. DEL ANCLAJE	LLAVE DE INSTALACIÓN	PAR DE APRIETE (NM)	LETRA EJE	Ø ELEMENTO A FIJAR	MÍN. ESPESOR MATERIAL BASE	DISTANCIA MÍN. AL BORDE "A"	DISTANCIA MÍN. ENTRE EJES "B"	EXTRACCIÓN HORMIGÓN NO-FISURADO	CIZALLADURA HORMIGÓN NO-FISURADO	EXTRACCIÓN HORMIGÓN FISURADO	CIZALLADURA HORMIGÓN FISURADO
APX08050	M8 x 50	2	8	40	37	13	15	A	9	100	72	144	182	392	130	275
APX08075	M8 x 75	9	8	60	55	13	15	C	9	100	72	144	364	641	243	556
APX08080	M8 x 80	14	8	60	55	13	15	D	9	100	72	144	364	641	243	556
APX08095	M8 x 95	29	8	60	55	13	15	E	9	100	72	144	364	641	243	556
APX08115	M8 x 115	49	8	60	55	13	15	G	9	100	72	144	364	641	243	556
APX10090	M10 x 90	10	10	75	68	17	40	E	12	120	90	180	777	1014	437	1014
APX10105	M10 x 105	25	10	75	68	17	40	F	12	120	90	180	777	1014	437	1014
APX10115	M10 x 115	35	10	75	68	17	40	G	12	120	90	180	777	1014	437	1014
APX10135	M10 x 135	55	10	75	68	17	40	H	12	120	90	180	777	1014	437	1014
APX10165	M10 x 165	85	10	75	68	17	40	K	12	120	90	180	777	1014	437	1014
APX10185	M10 x 185	105	10	75	68	17	40	L	12	120	90	180	777	1014	437	1014
APX12080	M12 x 80	4	12	65	60	19	60	D	14	100	105	210	488	1474	348	1182
APX12100	M12 x 100	4	12	85	80	19	60	E	14	140	105	210	1214	1474	777	1474
APX12110	M12 x 110	14	12	85	80	19	60	F	14	140	105	210	1214	1474	777	1474
APX12120	M12 x 120	24	12	85	80	19	60	G	14	140	105	210	1214	1474	777	1474
APX12130	M12 x 130	34	12	85	80	19	60	H	14	140	105	210	1214	1474	777	1474
APX12150	M12 x 150	54	12	85	80	19	60	I	14	140	105	210	1214	1474	777	1474
APX12180	M12 x 180	84	12	85	80	19	60	L	14	140	105	210	1214	1474	777	1474
APX12200	M12 x 200	104	12	85	80	19	60	M	14	140	105	210	1214	1474	777	1474
APX12220	M12 x 220	124	12	85	80	19	60	O	14	140	105	210	1214	1474	777	1474
APX12255	M12 x 255	159	12	85	80	19	60	R	14	140	105	210	1214	1474	777	1474
APX16145	M16 x 145	28	16	105	97	24	100	I	18	170	128	255	1699	2744	1214	2620
APX16175	M16 x 175	58	16	105	97	24	100	K	18	170	128	255	1699	2744	1214	2620
APX16220	M16 x 220	103	16	105	97	24	100	O	18	170	128	255	1699	2744	1214	2620
APX16250	M16 x 250	133	16	105	97	24	100	Q	18	170	128	255	1699	2744	1214	2620
APX20170	M20 x 170	32	20	125	114	30	200	K	22	200	150	300	2388	4258	1456	3343
APX20200	M20 x 200	62	20	125	114	30	200	M	22	200	150	300	2388	4258	1456	3343

MTP-G

Homologado ETE Opt.1. Eje ATLANTIS C3-L. Clip Inoxidable A4

CÓDIGO	MXL	ESPEJOR MÁX. A FIJAR	Ø BROCA	PROFUNDIDAD MÍN. DE TALADRO	PROFUNDIDAD MÍN. DEL ANCLAJE	LLAVE DE INSTALACIÓN	PAR DE APRIETE (NM)	LETRA EJE	Ø ELEMENTO A FIJAR	MÍN. ESPESOR MATERIAL BASE	DISTANCIA MÍN. AL BORDE "A"	DISTANCIA MÍN. ENTRE EJES "B"	EXTRACCIÓN HORMIGÓN NO-FISURADO	CIZALLADURA HORMIGÓN NO-FISURADO	EXTRACCIÓN HORMIGÓN FISURADO	CIZALLADURA HORMIGÓN FISURADO
APG06060	M6 x 60	10	6	50	46	10	7	B	7	100	60	120	243	352	-	-
APG06070	M6 x 70	20	6	50	46	10	7	C	7	100	60	120	243	352	-	-
APG06100	M6 x 100	50	6	50	46	10	7	E	7	100	60	120	243	352	-	-
APG08050	M8 x 50	2	8	40	37	13	15	A	9	100	72	144	182	392	130	275
APG08060	M8 x 60	12	8	40	37	13	15	B	9	100	72	144	182	392	130	275
APG08075	M8 x 75	9	8	60	55	13	15	C	9	100	72	144	364	641	243	556
APG08095	M8 x 95	29	8	60	55	13	15	E	9	100	72	144	364	641	243	556
APG08115	M8 x 115	49	8	60	55	13	15	G	9	100	72	144	364	641	243	556
APG10070	M10 x 70	5	10	60	53	17	40	C	12	100	90	180	325	1014	232	1009
APG10090	M10 x 90	10	10	75	68	17	40	E	12	120	90	180	777	1014	437	1014
APG10105	M10 x 105	25	10	75	68	17	40	F	12	120	90	180	777	1014	437	1014
APG10115	M10 x 115	35	10	75	68	17	40	G	12	120	90	180	777	1014	437	1014
APG10135	M10 x 135	55	10	75	68	17	40	H	12	120	90	180	777	1014	437	1014
APG10165	M10 x 165	85	10	75	68	17	40	K	12	120	90	180	777	1014	437	1014
APG10185	M10 x 185	105	10	75	68	17	40	L	12	120	90	180	777	1014	437	1014
APG12080	M12 x 80	4	12	65	60	19	60	D	14	100	105	210	585	1474	417	1182
APG12110	M12 x 110	14	12	85	80	19	60	F	14	140	105	210	1399	1474	777	1474
APG12130	M12 x 130	34	12	85	80	19	60	H	14	140	105	210	1399	1474	777	1474
APG12150	M12 x 150	54	12	85	80	19	60	I	14	140	105	210	1399	1474	777	1474
APG12180	M12 x 180	84	12	85	80	19	60	L	14	140	105	210	1399	1474	777	1474
APG12200	M12 x 200	104	12	85	80	19	60	M	14	140	105	210	1399	1474	777	1474
APG16125	M16 x 125	8	16	105	97	24	100	G	18	170	128	255	1699	2744	1214	2620
APG16145	M16 x 145	28	16	105	97	24	100	I	18	170	128	255	1699	2744	1214	2620
APG16175	M16 x 175	58	16	105	97	24	100	K	18	170	128	255	1699	2744	1214	2620
APG16220	M16 x 220	103	16	105	97	24	100	O	18	170	128	255	1699	2744	1214	2620
APG20170	M20 x 170	32	20	125	114	30	200	K	22	200	150	300	2388	4258	1456	3343
APG20200	M20 x 200	62	20	125	114	30	200	M	22	200	150	300	2388	4258	1456	3343

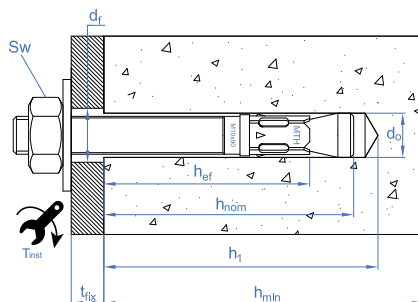

MTH

Homologado ETE Opt.7. Eje cincado. Clip cincado

CÓDIGO	MXL	ESPESOR MÁX. A FIJAR	Ø BROCA	PROFUNDIDAD MÍN. DE TALADRO	PROFUNDIDAD MÍN. DEL ANCLAJE	LLAVE DE INSTALACIÓN	PAR DE APRIETE (NM)	LETRA EJE	Ø ELEMENTO A FIJAR	MÍN. ESPESOR MATERIAL BASE	DISTANCIA MÍN. AL BORDE "A"	DISTANCIA MÍN. ENTRE EJES "B"	EXTRACCIÓN HORMIGÓN NO-FISURADO	CIZALLADURA HORMIGÓN NO-FISURADO
AH06060	M6 x 60	2	6	55	50	10	7	B	7	100	60	120	385	297
AH06070	M6 x 70	12	6	55	50	10	7	C	7	100	60	120	385	297
AH06080	M6 x 80	22	6	55	50	10	7	D	7	100	60	120	385	297
AH06090	M6 x 90	32	6	55	50	10	7	E	7	100	60	120	385	297
AH06100	M6 x 100	42	6	55	50	10	7	E	7	100	60	120	385	297
AH06110	M6 x 110	52	6	55	50	10	7	F	7	100	60	120	385	297
AH06120	M6 x 120	62	6	55	50	10	7	G	7	100	60	120	385	297
AH06130	M6 x 130	72	6	55	50	10	7	H	7	100	60	120	385	297
AH06140	M6 x 140	82	6	55	50	10	7	I	7	100	60	120	385	297
AH06150	M6 x 150	92	6	55	50	10	7	I	7	100	60	120	385	297
AH06160	M6 x 160	102	6	55	50	10	7	J	7	100	60	120	385	297
AH06170	M6 x 170	112	6	55	50	10	7	K	7	100	60	120	385	297
AH06180	M6 x 180	122	6	55	50	10	7	L	7	100	60	120	385	297
AH08060	M8 x 60	3	8	50	50	13	20	B	9	100	53	105	485	494
AH08075	M8 x 75	5	8	65	60	13	20	C	9	100	72	144	676	542
AH08090	M8 x 90	20	8	65	60	13	20	E	9	100	72	144	676	542
AH08100	M8 x 100	30	8	65	60	13	20	E	9	100	72	144	676	542
AH08115	M8 x 115	45	8	65	60	13	20	G	9	100	72	144	676	542
AH08120	M8 x 120	50	8	65	60	13	20	G	9	100	72	144	676	542
AH08130	M8 x 130	60	8	65	60	13	20	H	9	100	72	144	676	542
AH08155	M8 x 155	85	8	65	60	13	20	J	9	100	72	144	676	542
AH10070	M10 x 70	3	10	60	54	17	35	C	12	100	63	126	650	650
AH10080	M10 x 80	13	10	60	54	17	35	D	12	100	63	126	650	650
AH10090	M10 x 90	10	10	75	67	17	35	E	12	110	83	165	922	856
AH10100	M10 x 100	20	10	75	67	17	35	E	12	110	83	165	922	856
AH10120	M10 x 120	40	10	75	67	17	35	G	12	110	83	165	922	856
AH10140	M10 x 140	60	10	75	67	17	35	H	12	110	83	165	922	856
AH10150	M10 x 150	70	10	75	67	17	35	I	12	110	83	165	922	856
AH10160	M10 x 160	80	10	75	67	17	35	J	12	110	83	165	922	856
AH10170	M10 x 170	90	10	75	67	17	35	K	12	110	83	165	922	856
AH10210	M10 x 210	130	10	75	67	17	35	N	12	110	83	165	922	856
AH10230	M10 x 230	150	10	75	67	17	35	P	12	110	83	165	922	856
AH12090	M12 x 90	13	12	70	60	19	60	E	14	100	75	150	844	844
AH12100	M12 x 100	8	12	85	77	19	60	E	14	130	75	150	1251	1200
AH12110	M12 x 110	18	12	85	77	19	60	F	14	130	98	195	1251	1200
AH12120	M12 x 120	28	12	85	77	19	60	G	14	130	98	195	1251	1200
AH12130	M12 x 130	38	12	85	77	19	60	H	14	130	98	195	1251	1200
AH12140	M12 x 140	48	12	85	77	19	60	H	14	130	98	195	1251	1200
AH12160	M12 x 160	68	12	85	77	19	60	J	14	130	98	195	1251	1200
AH12180	M12 x 180	88	12	85	77	19	60	L	14	130	98	195	1251	1200
AH12200	M12 x 200	108	12	85	77	19	60	M	14	130	98	195	1251	1200
AH12220	M12 x 220	128	12	85	77	19	60	O	14	130	98	195	1251	1200
AH12250	M12 x 250	158	12	85	77	19	60	Q	14	130	98	195	1251	1200
AH14120	M14 x 120	12	14	100	91	22	90	G	16	150	113	225	1551	1637
AH14145	M14 x 145	37	14	100	91	22	90	I	16	150	113	225	1551	1637
AH14170	M14 x 170	62	14	100	91	22	90	K	16	150	113	225	1551	1637
AH14220	M14 x 220	112	14	100	91	22	90	O	16	150	113	225	1551	1637
AH14250	M14 x 250	142	14	100	91	22	90	Q	16	150	113	225	1551	1637
AH16125	M16 x 125	3	16	110	104	24	120	G	18	168	126	252	1887	2237
AH16145	M16 x 145	23	16	110	104	24	120	I	18	168	126	252	1887	2237
AH16170	M16 x 170	48	16	110	104	24	120	K	18	168	126	252	1887	2237
AH16220	M16 x 220	98	16	110	104	24	120	O	18	168	126	252	1887	2237
AH16250	M16 x 250	128	16	110	104	24	120	Q	18	168	126	252	1887	2237
AH16280	M16 x 280	158	16	110	104	24	120	S	18	168	126	252	1887	2237

CÓDIGO	MXL	ESPESOR MÁX. A FIJAR	Ø BROCA	PROFUNDIDAD MÍN. DE TALADRO	PROFUNDIDAD MÍN. DEL ANCLAJE	LLAVE DE INSTALACIÓN	PAR DE APRIETE (NM)	LETRA EJE	Ø ELEMENTO A FIJAR	MÍN. ESPESOR MATERIAL BASE	DISTANCIA MÍN. AL BORDE "A"	DISTANCIA MÍN. ENTRE EJES "B"	EXTRACCIÓN HORMIGÓN NO-FISURADO	CIZALLADURA HORMIGÓN NO-FISURADO
AH20170	M20 x 170	23	20	135	125	30	240	K	22	206	155	309	2496	3279
AH20220	M20 x 220	73	20	135	125	30	240	O	22	206	155	309	2496	3279
AH20270	M20 x 270	123	20	135	125	30	240	S	22	206	155	309	2496	3279

MTH-A4 Homologado ETE Opt.7. Eje Inoxidable A4. Clip Inoxidable A4														
CÓDIGO	MXL	ESPESOR MÁX. A FIJAR	Ø BROCA	PROFUNDIDAD MÍN. DE TALADRO	PROFUNDIDAD MÍN. DEL ANCLAJE	LLAVE DE INSTALACIÓN	PAR DE APRIETE (NM)	LETRA EJE	Ø ELEMENTO A FIJAR	MÍN. ESPESOR MATERIAL BASE	DISTANCIA MÍN. AL BORDE "A"	DISTANCIA MÍN. ENTRE EJES "B"	EXTRACCIÓN HORMIGÓN NO-FISURADO	CIZALLADURA HORMIGÓN NO-FISURADO
MIA406045	M6 x 45	1	6	40	35	10	7	A	7	100	40	75	298	287
MIA406060	M6 x 60	2	6	55	50	10	7	B	7	100	60	120	438	287
MIA406080	M6 x 80	22	6	55	50	10	7	D	7	100	60	120	438	287
MIA408050	M8 x 50	4	8	40	35	13	20	A	9	100	40	75	219	263
MIA408075	M8 x 75	5	8	65	60	13	20	C	9	100	72	144	582	522
MIA408090	M8 x 90	20	8	65	60	13	20	E	9	100	72	144	582	522
MIA408115	M8 x 115	45	8	65	60	13	20	G	9	100	72	144	582	522
MIA410070	M10 x 70	3	10	60	54	17	35	C	12	100	60	120	485	650
MIA410090	M10 x 90	10	10	75	67	17	35	E	12	110	83	165	647	834
MIA410120	M10 x 120	40	10	75	67	17	35	G	12	110	83	165	647	834
MIA410150	M10 x 150	70	10	75	67	17	35	I	12	110	83	165	647	834
MIA412075	M12 x 75	5	12	60	55	19	60	C	14	100	65	130	561	673
MIA412090	M12 x 90	13	12	70	62	19	60	D	14	100	75	90	647	844
MIA412110	M12 x 110	12	12	85	77	19	60	F	14	130	98	195	1011	1207
MIA412140	M12 x 140	42	12	85	77	19	60	I	14	130	98	195	1011	1207
MIA416090	M16 x 90	4	16	75	69	24	120	D	18	100	75	150	683	819
MIA416145	M16 x 145	23	16	110	104	24	120	I	18	168	126	252	1416	2256
MIA416170	M16 x 170	48	16	110	104	24	120	K	18	168	126	252	1416	2256
MIA420120	M20 x 120	5	20	105	93	30	240	G	22	145	110	225	1190	2857
MIA420170	M20 x 170	23	20	135	125	30	240	K	22	206	155	309	2023	3521
MIA420220	M20 x 220	73	20	135	125	30	240	O	22	206	155	309	2023	3521

MTH-A2 Homologado ETE Opt.7. Eje Inoxidable A2. Clip Inoxidable A2														
CÓDIGO	MXL	ESPESOR MÁX. A FIJAR	Ø BROCA	PROFUNDIDAD MÍN. DE TALADRO	PROFUNDIDAD MÍN. DEL ANCLAJE	LLAVE DE INSTALACIÓN	PAR DE APRIETE (NM)	LETRA EJE	Ø ELEMENTO A FIJAR	MÍN. ESPESOR MATERIAL BASE	DISTANCIA MÍN. AL BORDE "A"	DISTANCIA MÍN. ENTRE EJES "B"	EXTRACCIÓN HORMIGÓN NO-FISURADO	CIZALLADURA HORMIGÓN NO-FISURADO
MI06045	M6 x 45	1	6	40	35	10	7	A	7	100	40	75	298	287
MI06060	M6 x 60	2	6	55	50	10	7	B	7	100	60	120	438	287
MI06080	M6 x 80	22	6	55	50	10	7	D	7	100	60	120	438	287
MI06120	M6 x 120	62	6	55	50	10	7	G	7	100	60	120	438	287
MI06140	M6 x 140	82	6	55	50	10	7	I	7	100	60	120	438	287
MI06160	M6 x 160	102	6	55	50	10	7	J	7	100	60	120	438	287
MI06170	M6 x 170	112	6	55	50	10	7	K	7	100	60	120	438	287
MI06180	M6 x 180	122	6	55	50	10	7	L	7	100	60	120	438	287
MI08050	M8 x 50	4	8	40	35	13	20	A	9	100	40	75	219	263
MI08075	M8 x 75	5	8	65	60	13	20	C	9	100	72	144	582	522
MI08090	M8 x 90	20	8	65	60	13	20	E	9	100	72	144	582	522
MI08115	M8 x 115	45	8	65	60	13	20	G	9	100	72	144	582	522
MI10070	M10 x 70	3	10	60	54	17	35	C	12	100	60	120	485	650
MI10090	M10 x 90	10	10	75	67	17	35	E	12	110	83	165	647	834
MI10120	M10 x 120	40	10	75	67	17	35	G	12	110	83	165	647	834
MI10150	M10 x 150	70	10	75	67	17	35	I	12	110	83	165	647	834
MI12075	M12 x 75	5	12	60	55	19	60	C	14	100	65	130	561	672
MI12090	M12 x 90	13	12	70	62	19	60	D	14	120	75	150	647	844
MI12110	M12 x 110	18	12	85	77	19	60	F	14	130	98	195	1011	1207
MI12140	M12 x 140	48	12	85	77	19	60	I	14	130	98	195	1011	1207
MI16090	M16 x 90	4	16	75	69	24	120	D	18	100	75	150	683	819
MI16145	M16 x 145	23	16	110	104	24	120	I	18	168	126	252	1416	2256
MI16170	M16 x 170	48	16	110	104	24	120	K	18	168	126	252	1416	2256
MI20120	M20 x 120	5	20	105	93	30	240	G	22	145	110	225	1190	2857
MI20170	M20 x 170	23	20	135	125	30	240	K	22	206	155	309	2023	3521
MI20220	M20 x 220	73	20	135	125	30	240	O	22	206	155	309	2023	3521

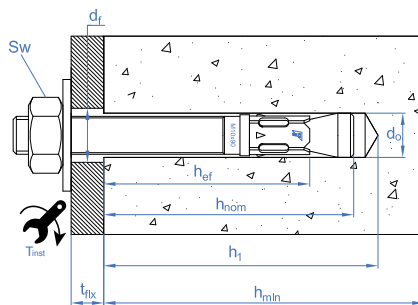

MTA

Eje cincado. Clip cincado

CÓDIGO	MXL	ESPESOR MÁX. A FIJAR	Ø BROCA	PROFUNDIDAD MIN. DE TALADRO	PROFUNDIDAD MIN. DEL ANCLAJE	LLAVE DE INSTALACIÓN	PAR DE APRIETE (NM)	Ø ELEMENTO A FIJAR	MÍN. ESPESOR MATERIAL BASE	DISTANCIA MIN. AL BORDE "A"	DISTANCIA MIN. ENTRE EJES "B"	EXTRACCIÓN HORMIGÓN NO-FISURADO	CIZALLADURA HORMIGÓN NO-FISURADO
AM06045	M6 x 45	1	6	40	35	10	7	7	100	40	75	298	297
AM06055	M6 x 55	11	6	40	35	10	7	7	100	40	75	298	297
AM06060	M6 x 60	2	6	55	50	10	7	7	100	60	120	385	297
AM06065	M6 x 65	7	6	55	50	10	7	7	100	60	120	385	297
AM06070	M6 x 70	12	6	55	50	10	7	7	100	60	120	385	297
AM06080	M6 x 80	22	6	55	50	10	7	7	100	60	120	385	297
AM06085	M6 x 85	27	6	55	50	10	7	7	100	60	120	385	297
AM06090	M6 x 90	32	6	55	50	10	7	7	100	60	120	385	297
AM06100	M6 x 100	42	6	55	50	10	7	7	100	60	120	385	297
AM06110	M6 x 110	52	6	55	50	10	7	7	100	60	120	385	297
AM06120	M6 x 120	62	6	55	50	10	7	7	100	60	120	385	297
AM06130	M6 x 130	72	6	55	50	10	7	7	100	60	120	385	297
AM06140	M6 x 140	82	6	55	50	10	7	7	100	60	120	385	297
AM06150	M6 x 150	92	6	55	50	10	7	7	100	60	120	385	297
AM06160	M6 x 160	102	6	55	50	10	7	7	100	60	120	385	297
AM06170	M6 x 170	112	6	55	50	10	7	7	100	60	120	385	297
AM06180	M6 x 180	122	6	55	50	10	7	7	100	60	120	385	297
AM08050	M8 x 50	4	8	40	35	13	20	9	100	40	75	263	263
AM08060	M8 x 60	3	8	50	47	13	20	9	100	53	105	485	494
AM08065	M8 x 65	8	8	50	47	13	20	9	100	53	105	485	494
AM08075	M8 x 75	5	8	65	60	13	20	9	100	72	144	676	542
AM08090	M8 x 90	20	8	65	60	13	20	9	100	72	144	676	542
AM08115	M8 x 115	45	8	65	60	13	20	9	100	72	144	676	542
AM08120	M8 x 120	50	8	65	60	13	20	9	100	72	144	676	542
AM08130	M8 x 130	60	8	65	60	13	20	9	100	72	144	676	542
AM08155	M8 x 155	85	8	65	60	13	20	9	100	72	144	676	542
AM10065	M10 x 65	1	10	55	52	17	35	12	100	60	120	604	604
AM10070	M10 x 70	3	10	60	54	17	35	12	100	63	125	650	650
AM10080	M10 x 80	13	10	60	54	17	35	12	100	63	125	667	667
AM10090	M10 x 90	10	10	75	67	17	35	12	110	83	165	922	856
AM10100	M10 x 100	20	10	75	67	17	35	12	110	83	165	922	856
AM10120	M10 x 120	40	10	75	67	17	35	12	110	83	165	922	856
AM10140	M10 x 140	60	10	75	67	17	35	12	110	83	165	922	856
AM10150	M10 x 150	70	10	75	67	17	35	12	110	83	165	922	856
AM10160	M10 x 160	80	10	75	67	17	35	12	110	83	165	922	856
AM10170	M10 x 170	90	10	75	67	17	35	12	110	83	165	922	856
AM10210	M10 x 210	130	10	75	67	17	35	12	110	83	165	922	856
AM10230	M10 x 230	150	10	75	67	17	35	12	110	83	165	922	856
AM12075	M12 x 75	5	12	60	55	19	60	14	100	65	130	673	673
AM12080	M12 x 80	3	12	70	62	19	60	14	100	75	150	844	844
AM12090	M12 x 90	13	12	70	62	19	60	14	100	75	150	844	844
AM12100	M12 x 100	8	12	85	77	19	60	14	130	98	195	1251	1200
AM12110	M12 x 110	18	12	85	77	19	60	14	130	98	195	1251	1200
AM12120	M12 x 120	28	12	85	77	19	60	14	130	98	195	1251	1200
AM12140	M12 x 140	48	12	85	77	19	60	14	130	98	195	1251	1200
AM12160	M12 x 160	68	12	85	77	19	60	14	130	98	195	1251	1200

CÓDIGO	MXL	ESPESOR MÁX. A FIJAR	Ø BROCA	PROFUNDIDAD MIN. DE TALADRO	PROFUNDIDAD MIN. DEL ANCLAJE	LLAVE DE INSTALACIÓN	PAR DE APRIETE (NM)	Ø ELEMENTO A FIJAR	MÍN. ESPESOR MATERIAL BASE	DISTANCIA MIN. AL BORDE "A"	DISTANCIA MIN. ENTRE EJES "B"	EXTRACCIÓN HORMIGÓN NO-FISURADO	CIZALLADURA HORMIGÓN NO-FISURADO
AM12180	M12 x 180	88	12	85	77	19	60	14	130	98	195	1251	1200
AM12220	M12 x 220	128	12	85	77	19	60	14	130	98	195	1251	1200
AM12250	M12 x 250	158	12	85	77	19	60	14	130	98	195	1251	1200
AM14080	M14 x 80	5	14	65	59	22	90	16	100	65	130	650	650
AM14100	M14 x 100	5	14	85	69	22	90	16	125	95	190	1166	1637
AM14120	M14 x 120	12	14	100	91	22	90	16	150	113	225	1551	1637
AM14145	M14 x 145	37	14	100	91	22	90	16	150	113	225	1551	1637
AM14170	M14 x 170	62	14	100	91	22	90	16	150	113	225	1551	1637
AM14220	M14 x 220	112	14	100	91	22	90	16	150	113	225	1551	1637
AM14250	M14 x 250	142	14	100	91	22	90	16	150	113	225	1551	1637
AM16090	M16 x 90	4	16	75	69	24	120	18	100	75	150	819	819
AM16110	M16 x 110	7	16	75	69	24	120	18	100	75	150	1838	2237
AM16125	M16 x 125	3	16	110	104	24	120	18	168	126	252	1838	2237
AM16145	M16 x 145	23	16	110	104	24	120	18	168	126	252	1838	2237
AM16170	M16 x 170	48	16	110	104	24	120	18	168	126	252	1838	2237
AM16220	M16 x 220	98	16	110	104	24	120	18	168	126	252	1838	2237
AM16250	M16 x 250	128	16	110	104	24	120	18	168	126	252	1838	2237
AM16280	M16 x 280	158	16	110	104	24	120	18	168	126	252	1838	2237
AM20120	M20 x 120	5	20	105	93	30	240	22	145	110	225	1429	2857
AM20170	M20 x 170	23	20	135	125	30	240	22	206	155	309	2496	3279
AM20220	M20 x 220	73	20	135	125	30	240	22	206	155	309	2496	3279
AM20270	M20 x 270	123	20	135	125	30	240	22	206	155	309	2496	3279
AM24180	M24 x 180	10	24	155	143	36	250	26	250	200	400	2023	4934
AM24260	M24 x 260	80	24	155	143	36	250	26	250	200	400	2023	4934

TH Anclaje de fijación directa en hormigón

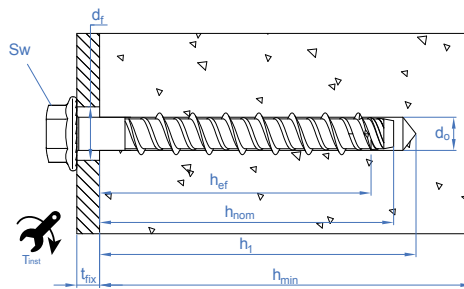

THE Homologado ETE Opt.1. Cabeza hexagonal con recubrimiento ATLANTIS C3-H

CÓDIGO	MXL	LONGITUD	Ø BROCA	PROFUNDIDAD MIN. DE TALADRO	MÍN. ESPESOR MATERIAL BASE	Ø ELEMENTO A FIJAR	PROFUNDIDAD MIN. DEL ANCLAJE	ESPESOR MÁX. A FIJAR	PAR DE APRIETE (NM)	DISTANCIA MIN. AL BORDE "A"	DISTANCIA MIN. ENTRE EJES "B"	LLAVE DE INSTALACIÓN	EXTRACCIÓN HORMIGÓN NO-FISURADO	CIZALLADURA HORMIGÓN NO-FISURADO	EXTRACCIÓN HORMIGÓN FISURADO	CIZALLADURA HORMIGÓN FISURADO
THE05040	Ø5 x 40	40	5	45	80	8	35	5	8	40	80	8	326	326	228	228
THE05050	Ø5 x 50	50	5	55	80	8	45	5	8	53	105	8	494	398	346	346
THE05060	Ø5 x 60	60	5	55	80	8	45	15	8	53	105	8	494	398	346	346
THE05080	Ø5 x 80	80	5	55	80	8	45	35	8	53	105	8	494	398	346	346
THE05100	Ø5 x 100	100	5	55	80	8	45	55	8	53	105	8	494	398	346	346
THE06040	Ø6 x 40	40	6	45	100	9	35	5	10	39	78	10	202	608	185	454
THE06050	Ø6 x 50	50	6	45	100	9	35	15	10	39	78	10	202	608	185	454
THE06060	Ø6 x 60	60	6	65	100	9	55	5	10	65	129	10	673	608	471	542
THE06070	Ø6 x 70	70	6	65	100	9	55	15	10	65	129	10	673	608	471	542
THE06080	Ø6 x 80	80	6	65	100	9	55	25	10	65	129	10	673	608	471	542
THE06100	Ø6 x 100	100	6	65	100	9	55	45	10	65	129	10	673	608	471	542
THE06120	Ø6 x 120	120	6	65	100	9	55	65	10	65	129	10	673	608	471	542
THE08055	Ø8 x 55	55	8	60	100	12	50	5	20	57	113	13	457	950	320	691
THE08060	Ø8 x 60	60	8	60	100	12	50	10	20	57	113	13	457	950	320	691
THE08070	Ø8 x 70	70	8	75	100	12	65	5	20	76	152	13	857	950	600	762
THE08080	Ø8 x 80	80	8	75	100	12	65	15	20	76	152	13	857	950	600	762
THE08090	Ø8 x 90	90	8	75	100	12	65	25	20	76	152	13	857	950	600	762
THE08100	Ø8 x 100	100	8	75	100	12	65	35	20	76	152	13	857	950	600	762
THE08110	Ø8 x 110	110	8	75	100	12	65	45	20	76	152	13	857	950	600	762
THE08120	Ø8 x 120	120	8	75	100	12	65	55	20	76	152	13	857	950	600	762
THE08140	Ø8 x 140	140	8	75	100	12	65	75	20	76	152	13	857	950	600	762
THE10060	Ø10 x 60	60	10	65	100	14	55	5	30	63	125	15	638	1245	447	871
THE10070	Ø10 x 70	70	10	65	100	14	55	15	30	63	125	15	638	1245	447	871
THE10080	Ø10 x 80	80	10	65	100	14	55	25	30	63	125	15	638	1245	447	871

CÓDIGO	MXL	LONGITUD	Ø BROCA	PROFUNDIDAD MÍN. DE TALADRO	MÍN. ESPESOR MATERIAL BASE	Ø ELEMENTO A FIJAR	PROFUNDIDAD MÍN. DEL ANCLAJE	ESPESOR MÁX. A FIJAR	PAR DE APRIETE (NM)	DISTANCIA MIN. AL BORDE "A"	DISTANCIA MÍN. ENTRE EJES "B"	LLAVE DE INSTALACIÓN	EXTRACCIÓN HORMIGÓN NO- FISURADO	CIZALLADURA HORMIGÓN NO- FISURADO	EXTRACCIÓN HORMIGÓN FISURADO	CIZALLADURA HORMIGÓN FISURADO
THE10090	Ø10 x 90	90	10	95	135	14	85	5	30	101	201	15	1310	1330	917	1330
THE10100	Ø10 x 100	100	10	95	135	14	85	15	30	101	201	15	1310	1330	917	1330
THE10120	Ø10 x 120	120	10	95	135	14	85	35	30	101	201	15	1310	1330	917	1330
THE10140	Ø10 x 140	140	10	95	135	14	85	55	30	101	201	15	1310	1330	917	1330
THE12080	Ø12 x 80	80	12	90	120	16	75	5	50	87	174	18	1055	1808	738	1720
THE12090	Ø12 x 90	90	12	90	120	16	75	15	50	87	174	18	1055	1808	738	1720
THE12110	Ø12 x 110	110	12	120	170	16	105	5	50	126	251	18	1822	1808	1275	1808
THE12130	Ø12 x 130	130	12	120	170	16	105	25	50	126	251	18	1822	1808	1275	1808
THE12150	Ø12 x 150	150	12	120	170	16	105	45	50	126	251	18	1822	1808	1275	1808
THE14080	Ø14 x 80	80	14	90	120	18	75	5	70	87	174	21	1055	2559	738	1883
THE14100	Ø14 x 100	100	14	90	120	18	75	25	70	87	174	21	1055	2559	738	1883
THE14120	Ø14 x 120	120	14	130	185	18	115	5	70	138	276	21	2107	2559	1475	2559
THE14130	Ø14 x 130	130	14	130	185	18	115	15	70	138	276	21	2107	2559	1475	2559
THE14140	Ø14 x 140	140	14	130	185	18	115	25	70	138	276	21	2107	2559	1475	2559
THE14160	Ø14 x 160	160	14	130	185	18	115	45	70	138	276	21	2107	2559	1475	2559
THE18100	Ø18 x 100	100	18	110	140	22	90	10	90	105	209	24	1384	3680	968	2576
THE18130	Ø18 x 130	130	18	110	140	22	90	40	90	105	209	24	1384	3680	968	2576
THE18160	Ø18 x 160	160	18	160	225	22	140	20	90	168	336	24	2830	3921	1981	3921
THE18180	Ø18 x 180	180	18	160	225	22	140	40	90	168	336	24	2830	3921	1981	3921
THE18200	Ø18 x 200	200	18	160	225	22	140	60	90	168	336	24	2830	3921	1981	3921

THA Homologado ETE Opt.1. Cabeza avellanada con recubrimiento ATLANTIS C3-H

CÓDIGO	MXL	LONGITUD	Ø BROCA	PROFUNDIDAD MÍN. DE TALADRO	MÍN. ESPESOR MATERIAL BASE	Ø ELEMENTO A FIJAR	PROFUNDIDAD MÍN. DEL ANCLAJE	ESPESOR MÁX. A FIJAR	PAR DE APRIETE (NM)	DISTANCIA MIN. AL BORDE "A"	DISTANCIA MÍN. ENTRE EJES "B"	LLAVE DE INSTALACIÓN	EXTRACCIÓN HORMIGÓN NO- FISURADO	CIZALLADURA HORMIGÓN NO- FISURADO	EXTRACCIÓN HORMIGÓN FISURADO	CIZALLADURA HORMIGÓN FISURADO
THA05040	Ø5 x 40	40	5	45	80	8	35	5	8	40	80	TX25	326	326	228	228
THA05060	Ø5 x 60	60	5	55	80	8	45	15	8	53	105	TX25	494	398	346	346
THA05080	Ø5 x 80	80	5	55	80	8	45	35	8	53	105	TX25	494	398	346	346
THA05100	Ø5 x 100	100	5	55	80	8	45	55	8	53	105	TX25	494	398	346	346
THA06045	Ø6 x 45	45	6	45	100	9	35	10	10	39	78	TX30	202	608	185	454
THA06050	Ø6 x 50	50	6	45	100	9	35	15	10	39	78	TX30	202	608	185	454
THA06060	Ø6 x 60	60	6	65	100	9	55	5	10	65	129	TX30	673	608	471	542
THA06080	Ø6 x 80	80	6	65	100	9	55	25	10	65	129	TX30	673	608	471	542
THA06120	Ø6 x 120	120	6	65	100	9	55	65	10	65	129	TX30	673	608	471	542
THA06140	Ø6 x 140	140	6	65	100	9	55	85	10	65	129	TX30	673	608	471	542
THA08060	Ø8 x 60	60	8	60	100	12	50	10	20	57	113	TX45	457	950	320	691
THA08080	Ø8 x 80	80	8	75	100	12	65	15	20	76	152	TX45	857	950	600	762
THA08100	Ø8 x 100	100	8	75	100	12	65	35	20	76	152	TX45	857	950	600	762
THA08120	Ø8 x 120	120	8	75	100	12	65	55	20	76	152	TX45	857	950	600	762
THA10100	Ø10 x 100	100	10	95	135	14	85	15	30	101	201	TX50	1310	1330	600	762
THA10120	Ø10 x 120	120	10	95	135	14	85	35	30	101	201	TX50	1310	1330	600	762

THP Homologado ETE Opt.1. Cabeza alomada con recubrimiento ATLANTIS C3-H

CÓDIGO	MXL	LONGITUD	Ø BROCA	PROFUNDIDAD MÍN. DE TALADRO	MÍN. ESPESOR MATERIAL BASE	Ø ELEMENTO A FIJAR	PROFUNDIDAD MÍN. DEL ANCLAJE	ESPESOR MÁX. A FIJAR	PAR DE APRIETE (NM)	DISTANCIA MIN. AL BORDE "A"	DISTANCIA MÍN. ENTRE EJES "B"	LLAVE DE INSTALACIÓN	EXTRACCIÓN HORMIGÓN NO- FISURADO	CIZALLADURA HORMIGÓN NO- FISURADO	EXTRACCIÓN HORMIGÓN FISURADO	CIZALLADURA HORMIGÓN FISURADO
THP05040	Ø5 x 40	40	5	45	80	8	35	5	8	40	80	TX30	326	326	228	228
THP05060	Ø5 x 60	60	5	65	80	8	55	15	8	53	105	TX30	494	398	346	346
THP06040	Ø6 x 40	40	6	45	100	9	35	5	10	39	78	TX40	202	608	185	454
THP06050	Ø6 x 50	50	6	45	100	9	35	15	10	39	78	TX40	202	608	185	454
THP06060	Ø6 x 60	60	6	65	100	9	55	5	10	65	129	TX40	673	608	471	542
THP06080	Ø6 x 80	80	6	65	100	9	55	25	10	65	129	TX40	673	608	471	542
THP06100	Ø6 x 100	100	6	65	100	9	55	45	10	65	129	TX40	673	608	471	542
THP08060	Ø8 x 60	60	8	60	100	12	50	10	20	57	113	TX45	457	950	320	691
THP08080	Ø8 x 80	80	8	75	100	12	65	15	20	76	152	TX45	857	950	600	762

THT Homologado ETE Opt.1. Cabeza Truss con recubrimiento ATLANTIS C3-H

CÓDIGO	MXL	LONGITUD	Ø BROCA	PROFUNDIDAD MÍN. DE TALADRO	MÍN. ESPESOR MATERIAL BASE	Ø ELEMENTO A FIJAR	PROFUNDIDAD MÍN. DEL ANCLAJE	ESPESOR MÁX. A FIJAR	PAR DE APRIETE (NM)	DISTANCIA MIN. AL BORDE "A"	DISTANCIA MÍN. ENTRE EJES "B"	LLAVE DE INSTALACIÓN	EXTRACCIÓN HORMIGÓN NO- FISURADO	CIZALLADURA HORMIGÓN NO- FISURADO	EXTRACCIÓN HORMIGÓN FISURADO	CIZALLADURA HORMIGÓN FISURADO
THT06040	Ø6 x 40	40	6	45	100	9	35	5	10	39	78	TX30	202	608	185	454
THT06050	Ø6 x 50	50	6	45	100	9	35	15	10	39	78	TX30	202	608	185	454
THT06060	Ø6 x 60	60	6	65	100	9	55	5	10	65	129	TX30	673	608	471	542

TFE Homologado ETE Opt.1. Cabeza hexagonal con recubrimiento cincado

CÓDIGO	MXL	LONGITUD	Ø BROCA	PROFUNDIDAD MÍN. DE TALADRO	MÍN. ESPESOR MATERIAL BASE	Ø ELEMENTO A FIJAR	PROFUNDIDAD MÍN. DEL ANCLAJE	ESPESOR MÁX. A FIJAR	PAR DE APRIETE (NM)	DISTANCIA MIN. AL BORDE "A"	DISTANCIA MÍN. ENTRE EJES "B"	LLAVE DE INSTALACIÓN	EXTRACCIÓN HORMIGÓN NO- FISURADO	CIZALLADURA HORMIGÓN NO- FISURADO	EXTRACCIÓN HORMIGÓN FISURADO	CIZALLADURA HORMIGÓN FISURADO
TFE05040	Ø5 x 40	40	5	45	80	8	35	5	8	40	80	8	326	326	228	228
TFE05050	Ø5 x 50	50	5	55	80	8	45	5	8	53	105	8	494	398	346	346
TFE05060	Ø5 x 60	60	5	55	80	8	45	15	8	53	105	8	494	398	346	346
TFE05080	Ø5 x 80	80	5	55	80	8	45	35	8	53	105	8	494	398	346	346
TFE05100	Ø5 x 100	100	5	55	80	8	45	55	8	53	105	8	494	398	346	346

CÓDIGO	MXL	LONGITUD	Ø BROCA	PROFUNDIDAD MÍN. DE TALADRO	MÍN. ESPESOR MATERIAL BASE	Ø ELEMENTO A FIJAR	PROFUNDIDAD MÍN. DEL ANCLAJE	ESPESOR MÁX. A FIJAR	PAR DE APRIETE (NM)	DISTANCIA MÍN. AL BORDE "A"	DISTANCIA MÍN. ENTRE EJES "B"	LLAVE DE INSTALACIÓN	EXTRACCIÓN HORMIGÓN NO-FISURADO	CIZALLADURA HORMIGÓN NO-FISURADO	EXTRACCIÓN HORMIGÓN FISURADO	CIZALLADURA HORMIGÓN FISURADO
TFE06040	Ø6 x 40	40	6	45	100	9	35	5	10	39	78	10	202	608	185	454
TFE06050	Ø6 x 50	50	6	45	100	9	35	15	10	39	78	10	202	608	185	454
TFE06060	Ø6 x 60	60	6	65	100	9	55	5	10	65	129	10	673	608	471	542
TFE06070	Ø6 x 70	70	6	65	100	9	55	15	10	65	129	10	673	608	471	542
TFE06080	Ø6 x 80	80	6	65	100	9	55	25	10	65	129	10	673	608	471	542
TFE06100	Ø6 x 100	100	6	65	100	9	55	45	10	65	129	10	673	608	471	542
TFE06120	Ø6 x 120	120	6	65	100	9	55	65	10	65	129	10	673	608	471	542
TFE08055	Ø8 x 55	55	8	60	100	12	50	5	20	57	113	13	457	950	320	691
TFE08060	Ø8 x 60	60	8	60	100	12	50	10	20	57	113	13	457	950	320	691
TFE08070	Ø8 x 70	70	8	75	100	12	65	5	20	76	152	13	857	950	600	762
TFE08080	Ø8 x 80	80	8	75	100	12	65	15	20	76	152	13	857	950	600	762
TFE08090	Ø8 x 90	90	8	75	100	12	65	25	20	76	152	13	857	950	600	762
TFE08100	Ø8 x 100	100	8	75	100	12	65	35	20	76	152	13	857	950	600	762
TFE08110	Ø8 x 110	110	8	75	100	12	65	45	20	76	152	13	857	950	600	762
TFE08120	Ø8 x 120	120	8	75	100	12	65	55	20	76	152	13	857	950	600	762
TFE08140	Ø8 x 140	140	8	75	100	12	65	75	20	76	152	13	857	950	600	762
TFE10060	Ø10 x 60	60	10	65	100	14	55	5	30	63	125	15	638	1245	447	871
TFE10070	Ø10 x 70	70	10	65	100	14	55	15	30	63	125	15	638	1245	447	871
TFE10080	Ø10 x 80	80	10	85	120	14	75	25	30	88	176	15	638	1245	447	871
TFE10090	Ø10 x 90	90	10	95	135	14	85	5	30	101	201	15	1310	1330	917	1330
TFE10100	Ø10 x 100	100	10	95	135	14	85	15	30	101	201	15	1310	1330	917	1330
TFE10120	Ø10 x 120	120	10	95	135	14	85	35	30	101	201	15	1310	1330	917	1330
TFE10140	Ø10 x 140	140	10	95	135	14	85	55	30	101	201	15	1310	1330	917	1330
TFE12080	Ø12 x 80	80	12	90	120	16	75	5	50	87	174	18	1055	1808	738	1720
TFE12090	Ø12 x 90	90	12	90	120	16	75	15	50	87	174	18	1055	1808	738	1720
TFE12110	Ø12 x 110	110	12	120	170	16	105	5	50	126	251	18	1822	1808	1275	1808
TFE12130	Ø12 x 130	130	12	120	170	16	105	25	50	126	251	18	1822	1808	1275	1808
TFE12150	Ø12 x 150	150	12	120	170	16	105	45	50	126	251	18	1822	1808	1275	1808
TFE14080	Ø14 x 80	80	14	90	120	18	75	5	70	87	174	21	1055	2559	738	1883
TFE14100	Ø14 x 100	100	14	90	120	18	75	25	70	87	174	21	1055	2559	738	1883
TFE14120	Ø14 x 120	120	14	130	185	18	115	5	70	138	276	21	2107	2559	1475	2559
TFE14130	Ø14 x 130	130	14	130	185	18	115	15	70	138	276	21	2107	2559	1475	2559
TFE14140	Ø14 x 140	140	14	130	185	18	115	25	70	138	276	21	2107	2559	1475	2559
TFE14160	Ø14 x 160	160	14	130	185	18	115	45	70	138	276	21	2107	2559	1475	2559
TFE18100	Ø18 x 100	100	18	110	140	22	90	10	90	105	209	24	1384	3680	968	2576
TFE18130	Ø18 x 130	130	18	110	140	22	90	40	90	105	209	24	1384	3680	968	2576
TFE18160	Ø18 x 160	160	18	160	225	22	140	20	90	168	336	24	2830	3921	1981	3921
TFE18180	Ø18 x 180	180	18	160	225	22	140	40	90	168	336	24	2830	3921	1981	3921
TFE18200	Ø18 x 200	200	18	160	225	22	140	60	90	168	336	24	2830	3921	1981	3921

TFN Homologado ETE Opt.1. Cabeza hexagonal con recubrimiento cincado y sin arandela

CÓDIGO	MXL	LONGITUD	Ø BROCA	PROFUNDIDAD MÍN. DE TALADRO	MÍN. ESPESOR MATERIAL BASE	Ø ELEMENTO A FIJAR	PROFUNDIDAD MÍN. DEL ANCLAJE	ESPESOR MÁX. A FIJAR	PAR DE APRIETE (NM)	DISTANCIA MÍN. AL BORDE "A"	DISTANCIA MÍN. ENTRE EJES "B"	LLAVE DE INSTALACIÓN	EXTRACCIÓN HORMIGÓN NO-FISURADO	CIZALLADURA HORMIGÓN NO-FISURADO	EXTRACCIÓN HORMIGÓN FISURADO	CIZALLADURA HORMIGÓN FISURADO
TFN14080	Ø14 x 80	80	14	90	120	18	75	5	70	87	174	24	1055	2559	738	1883

TFS Homologado ETE Opt.1. Espárrago cincado

CÓDIGO	MXL	LONGITUD	Ø BROCA	PROFUNDIDAD MÍN. DE TALADRO	MÍN. ESPESOR MATERIAL BASE	Ø ELEMENTO A FIJAR	PROFUNDIDAD MÍN. DEL ANCLAJE	ESPESOR MÁX. A FIJAR	PAR DE APRIETE (NM)	DISTANCIA MÍN. AL BORDE "A"	DISTANCIA MÍN. ENTRE EJES "B"	LLAVE DE INSTALACIÓN	EXTRACCIÓN HORMIGÓN NO-FISURADO	CIZALLADURA HORMIGÓN NO-FISURADO	EXTRACCIÓN HORMIGÓN FISURADO	CIZALLADURA HORMIGÓN FISURADO
TFS06100	Ø6 x 100	100	6	65	100	9	55	35	10	65	129	5	673	608	471	542
TFS06120	Ø6 x 120	120	6	65	100	9	55	55	10	65	129	5	673	608	471	542
TFS08110	Ø8 x 110	110	8	75	100	12	65	32	20	76	152	7	857	950	600	762
TFS08130	Ø8 x 130	130	8	75	100	12	65	52	20	76	152	7	857	950	600	762
TFS10120	Ø10 x 120	120	10	85	120	14	75	27	30	88	176	8	1068	1330	748	987
TFS10140	Ø10 x 140	140	10	85	120	14	75	47	30	88	176	8	1068	1330	748	987

TFF Homologado ETE Opt.1. Rosca hembra métrica cincada

CÓDIGO	MXL	LONGITUD	Ø BROCA	PROFUNDIDAD MÍN. DE TALADRO	MÍN. ESPESOR MATERIAL BASE	Ø ELEMENTO A FIJAR	PROFUNDIDAD MÍN. DEL ANCLAJE	PAR DE APRIETE (NM)	DISTANCIA MÍN. AL BORDE "A"	DISTANCIA MÍN. ENTRE EJES "B"	LLAVE DE INSTALACIÓN	EXTRACCIÓN HORMIGÓN NO-FISURADO	CIZALLADURA HORMIGÓN NO-FISURADO	EXTRACCIÓN HORMIGÓN FISURADO	CIZALLADURA HORMIGÓN FISURADO
TFF06035	Ø6 x 35	35	6	45	100	--	35	10	39	78	13	202	608	185	454
TFF06055	Ø6 x 55	55	6	55	100	--	55	10	65	129	13	673	608	471	542

TFM Homologado ETE Opt.1. Rosca macho métrica cincado

CÓDIGO	MXL	LONGITUD	Ø BROCA	PROFUNDIDAD MÍN. DE TALADRO	MÍN. ESPESOR MATERIAL BASE	Ø ELEMENTO A FIJAR	PROFUNDIDAD MÍN. DEL ANCLAJE	PAR DE APRIETE (NM)	DISTANCIA MÍN. AL BORDE "A"	DISTANCIA MÍN. ENTRE EJES "B"	LLAVE DE INSTALACIÓN	EXTRACCIÓN HORMIGÓN NO-FISURADO	CIZALLADURA HORMIGÓN NO-FISURADO	EXTRACCIÓN HORMIGÓN FISURADO	CIZALLADURA HORMIGÓN FISURADO
TFM06035	Ø6 x 35	35	6	45	100	--	35	10	39	78	13	202	608	185	454
TFM06055	Ø6 x 55	55	6	55	100	--	55	10	65	129	13	673	608	471	542

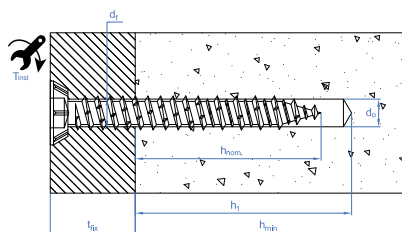

HP

Cabeza plana, TX. Bicromatado

CÓDIGO	MXL	ESPOSOR MÁX. A FIJAR	Ø BROCA	PROFUNDIDAD MÍN. DE TALADRO	PROFUNDIDAD MÍN. DEL ANCLAJE	LLAVE DE INSTALACIÓN	PAR DE APRIETE (NM)	Ø ELEMENTO A FIJAR	MÍN. ESPESOR MATERIAL BASE	EXTRACCIÓN HORMIGÓN NO-FISURADO	CIZALLADURA HORMIGÓN NO-FISURADO
HP75072	7,5 x 72	32	6	45	40	TX30	20	9	100	100	-
HP75092	7,5 x 92	52	6	45	40	TX30	20	9	100	100	-
HP75112	7,5 x 112	72	6	45	40	TX30	20	9	100	100	-
HP75132	7,5 x 132	92	6	45	40	TX30	20	9	100	100	-
HP75152	7,5 x 152	112	6	45	40	TX30	20	9	100	100	-
HP75182	7,5 x 182	142	6	45	40	TX30	20	9	100	100	-
HPZ75072	7,5 x 72	32	6	45	40	TX30	20	9	100	100	-
HPZ75092	7,5 x 92	52	6	45	40	TX30	20	9	100	100	-
HPZ75112	7,5 x 112	72	6	45	40	TX30	20	9	100	100	-
HPZ75132	7,5 x 132	92	6	45	40	TX30	20	9	100	100	-
HPZ75152	7,5 x 152	112	6	45	40	TX30	20	9	100	100	-
HPZ75182	7,5 x 182	142	6	45	40	TX30	20	9	100	100	-
HPZ75212	7,5 x 212	172	6	45	40	TX30	20	9	100	100	-

HR

Cabeza cilíndrica, Tx

CÓDIGO	MXL	ESPOSOR MÁX. A FIJAR	Ø BROCA	PROFUNDIDAD MÍN. DE TALADRO	PROFUNDIDAD MÍN. DEL ANCLAJE	LLAVE DE INSTALACIÓN	PAR DE APRIETE (NM)	Ø ELEMENTO A FIJAR	MÍN. ESPESOR MATERIAL BASE	DISTANCIA MÍN. AL BORDE "A"	DISTANCIA MÍN. ENTRE EJES "B"	EXTRACCIÓN HORMIGÓN NO-FISURADO	CIZALLADURA HORMIGÓN NO-FISURADO
HR75072	7,5 x 72	32	6	45	40	TX25	15	9	100			100	-
HR75092	7,5 x 92	52	6	45	40	TX25	15	9	100			100	-
HR75112	7,5 x 112	72	6	45	40	TX25	15	9	100			100	-
HR75132	7,5 x 132	92	6	45	40	TX25	15	9	100			100	-

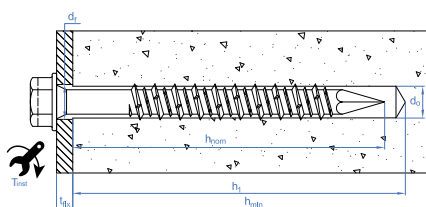

HE

Tornillo con cabeza hexagonal

CÓDIGO	MXL	ESPOSOR MÁX. A FIJAR	Ø BROCA	PROFUNDIDAD MÍN. DE TALADRO	PROFUNDIDAD MÍN. DEL ANCLAJE	LLAVE DE INSTALACIÓN	PAR DE APRIETE (NM)	Ø ELEMENTO A FIJAR	MÍN. ESPESOR MATERIAL BASE	EXTRACCIÓN HORMIGÓN NO-FISURADO	CIZALLADURA HORMIGÓN NO-FISURADO
HE65032	6,5 x 32	2	5	35	30	8+ ranura	12	8	100	65	-
HE65045	6,5 x 45	15	5	35	30	8+ ranura	12	8	100	65	-
HE65057	6,5 x 57	27	5	35	30	8+ ranura	12	8	100	65	-
HE65070	6,5 x 70	40	5	35	30	8+ ranura	12	8	100	65	-
HE65080	6,5 x 80	50	5	35	30	8+ ranura	12	8	100	65	-
HE65100	6,5 x 100	70	5	35	30	8+ ranura	12	8	100	65	-
HE65125	6,5 x 125	95	5	35	30	8+ ranura	12	8	100	65	-

HE + ARVUL

Tornillo montado con arandela vulcanizada de acero-EPDM

CÓDIGO	MXL	ESPESOR MÁX. A FIJAR	Ø BROCA	PROFUNDIDAD MÍN. DE TALADRO	PROFUNDIDAD MÍN. DEL ANCLAJE	LLAVE DE INSTALACIÓN	PAR DE APRIETE (NM)	Ø ELEMENTO A FIJAR	MÍN. ESPESOR MATERIAL BASE	EXTRACCIÓN HORMIGÓN NO-FISURADO	CIZALLADURA HORMIGÓN NO-FISURADO
HE1665032	6,5 x 32	2	5	35	30	8+ ranura	12	8	100	65	-
HE1665045	6,5 x 45	15	5	35	30	8+ ranura	12	8	100	65	-
HE1665057	6,5 x 57	27	5	35	30	8+ ranura	12	8	100	65	-
HE1665070	6,5 x 70	40	5	35	30	8+ ranura	12	8	100	65	-
HE1665080	6,5 x 80	50	5	35	30	8+ ranura	12	8	100	65	-
HE1665100	6,5 x 100	70	5	35	30	8+ ranura	12	8	100	65	-
HE1665125	6,5 x 125	95	5	35	30	8+ ranura	12	8	100	65	-

SL

Anclaje de seguridad para grandes cargas en hormigón

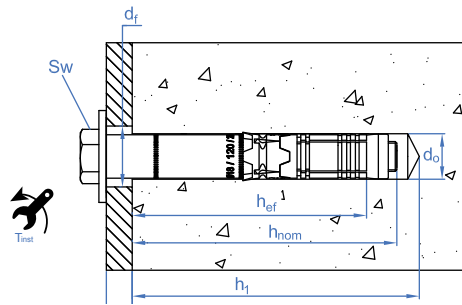

SL-PT

Homologado ETE Opt.1. Cabeza hexagonal

CÓDIGO	MXL	ESPESOR MÁX. A FIJAR	Ø BROCA	PROFUNDIDAD MÍN. DE TALADRO	PROFUNDIDAD MÍN. DEL ANCLAJE	LLAVE DE INSTALACIÓN	PAR DE APRIETE (NM)	Ø ELEMENTO A FIJAR	MÍN. ESPESOR MATERIAL BASE	DISTANCIA MÍN. AL BORDE "A"	DISTANCIA MÍN. ENTRE EJES "B"	EXTRACCIÓN HORMIGÓN NO-FISURADO	CIZALLADURA HORMIGÓN NO-FISURADO	EXTRACCIÓN HORMIGÓN FISURADO	CIZALLADURA HORMIGÓN FISURADO
SLPT10070	M6 x 70	10	10	70	59	10	15	12	100	75	150	782	844	591	591
SLPT10080	M6 x 80	20	10	70	59	10	15	12	100	75	150	782	844	591	591
SLPT10100	M6x 100	40	10	70	59	10	15	12	100	75	150	782	844	591	591
SLPT10110	M6 x 110	50	10	70	59	10	15	12	100	75	150	782	844	591	591
SLPT12080	M8 x 80	5	12	85	72	13	30	14	120	90	180	1110	1922	777	1554
SLPT12090	M8 x 90	15	12	85	72	13	30	14	120	90	180	1110	1922	777	1554
SLPT12100	M8 x 100	25	12	85	72	13	30	14	120	90	180	1110	1922	777	1554
SLPT12120	M8 x 120	45	12	85	72	13	30	14	120	90	180	1110	1922	777	1554
SLPT16100	M10 x 100	15	16	95	83	17	50	18	140	105	210	1399	2797	979	1958
SLPT16120	M10 x 120	35	16	95	83	17	50	18	140	105	210	1399	2797	979	1958
SLPT16140	M10 x 140	55	16	95	83	17	50	18	140	105	210	1399	2797	979	1958
SLPT16160	M10 x 160	75	16	95	83	17	50	18	140	105	210	1399	2797	979	1958
SLPT18110	M12 x 110	10	18	110	97	19	80	20	170	130	255	1871	3743	1310	2620
SLPT18120	M12 x 120	20	18	110	97	19	80	20	170	130	255	1871	3743	1310	2620
SLPT18140	M12 x 140	40	18	110	97	19	80	20	170	130	255	1871	3743	1310	2620
SLPT18150	M12 x 150	50	18	110	97	19	80	20	170	130	255	1871	3743	1310	2620
SLPT18170	M12 x 170	70	18	110	97	19	80	20	170	130	255	1871	3743	1310	2620
SLPT18200	M12 x 200	100	18	110	97	19	80	20	170	130	255	1871	3743	1310	2620
SLPT24140	M16 x 140	20	24	130	117	24	160	26	200	150	300	1990	4776	1393	3343
SLPT24170	M16 x 170	50	24	130	117	24	160	26	200	150	300	1990	4776	1393	3343
SLPT24200	M16 x 200	80	24	130	117	24	160	26	200	150	300	1990	4776	1393	3343
SLPT24220	M16 x 220	100	24	130	117	24	160	26	200	150	300	1990	4776	1393	3343
SLPT28170	M20 x 170	20	28	160	146	30	240	31	250	190	375	2781	6674	1947	4672
SLPT28200	M20 x 200	50	28	160	146	30	240	31	250	190	375	2781	6674	1947	4672
SLPT28240	M20 x 240	90	28	160	146	30	240	31	250	190	375	2781	6674	1947	4672

SL-PC

Homologado ETE Opt.1. Cabeza avellanada

CÓDIGO	MXL	ESPESOR MÁX. A FIJAR	Ø BROCA	PROFUNDIDAD MÍN. DE TALADRO	PROFUNDIDAD MÍN. DEL ANCLAJE	LLAVE DE INSTALACIÓN	PAR DE APRIETE (NM)	Ø ELEMENTO A FIJAR	MÍN. ESPESOR MATERIAL BASE	DISTANCIA MÍN. AL BORDE "A"	DISTANCIA MÍN. ENTRE EJES "B"	EXTRACCIÓN HORMIGÓN NO-FISURADO	CIZALLADURA HORMIGÓN NO-FISURADO	EXTRACCIÓN HORMIGÓN FISURADO	CIZALLADURA HORMIGÓN FISURADO
SLPC10070	M6 x 70	10	10	70	59	4	15	12	100	75	150	782	844	591	591
SLPC10080	M6 x 80	20	10	70	59	4	15	12	100	75	150	782	844	591	591
SLPC10100	M6 x 100	40	10	70	59	4	15	12	100	75	150	782	844	591	591
SLPC12100	M8 x 100	25	12	85	72	5	30	14	120	90	180	1110	1922	777	1554
SLPC16100	M10 x 100	15	16	95	83	6	50	18	140	105	210	1399	2797	979	1958
SLPC16120	M10 x 120	35	16	95	83	6	50	18	140	105	210	1399	2797	979	1958
SLPC18120	M12 x 120	20	18	110	97	8	80	20	170	130	255	1871	3743	1310	2620

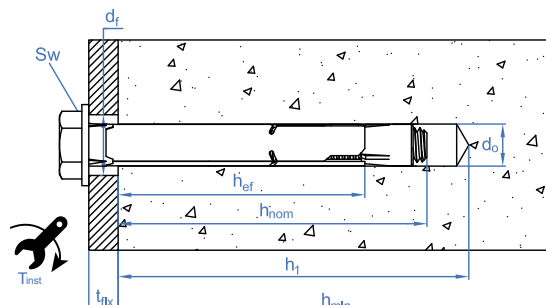

CH-TO

Tornillo hexagonal 6.8. Homologado ETE Opt.7

CÓDIGO	MXL	ESPESOR MÁX. A FIJAR	Ø BROCA	PROFUNDIDAD MÍN. DE TALADRO	PROFUNDIDAD MÍN. DEL ANCLAJE	LLAVE DE INSTALACIÓN	PAR DE APRIETE (NM)	Ø ELEMENTO A FIJAR	MÍN. ESPESOR MATERIAL BASE	DISTANCIA MÍN. AL BORDE "A"	DISTANCIA MÍN. ENTRE EJES "B"	EXTRACCIÓN HORMIGÓN NO-FISURADO	CIZALLADURA HORMIGÓN NO-FISURADO
ACHT08C	M6 x 45	5	8	45	39	10	10	9	100	41	41	267	351
ACHT08L	M6 x 60	20	8	45	39	10	10	9	100	41	41	267	351
ACHT09C	M6 x 45	5	9	45	39	10	10	10	100	41	41	267	351
ACHT09L	M6 x 60	20	9	45	39	10	10	10	100	41	41	267	351
ACHT10C	M8 x 60	5	10	60	51	13	20	12	100	54	54	485	604
ACHT10L	M8 x 80	27	10	60	51	13	20	12	100	54	54	485	604
ACHT11C	M8 x 60	5	11	60	51	13	20	13	100	54	54	485	604
ACHT11L	M8 x 80	27	11	60	51	13	20	13	100	54	54	485	604
ACHT12C	M10 x 70	5	12	75	65	17	35	14	100	65	65	662	794
ACHT12L	M10 x 100	32	12	75	65	17	35	14	100	65	65	662	794
ACHT14C	M10 x 70	5	14	75	65	17	35	16	100	65	65	662	794
ACHT14L	M10 x 100	32	14	75	65	17	35	16	100	65	65	662	794
ACHT16C	M12 x 80	5	16	80	70	19	50	18	110	74	74	812	974
ACHT16L	M12 x 110	37	16	80	70	19	50	18	110	74	74	812	974
ACHT20C	M16 x 110	15	20	105	92	24	140	22	145	97	97	1459	2744
ACHT25C	M20 x 130	25	25	130	102	30	240	27	160	120	240	1424	3417

CH-A2

Inoxidable A2. Homologado ETE Opt.7

CÓDIGO	MXL	ESPESOR MÁX. A FIJAR	Ø BROCA	PROFUNDIDAD MÍN. DE TALADRO	PROFUNDIDAD MÍN. DEL ANCLAJE	LLAVE DE INSTALACIÓN	PAR DE APRIETE (NM)	Ø ELEMENTO A FIJAR	MÍN. ESPESOR MATERIAL BASE	DISTANCIA MÍN. AL BORDE "A"	DISTANCIA MÍN. ENTRE EJES "B"	EXTRACCIÓN HORMIGÓN NO-FISURADO	CIZALLADURA HORMIGÓN NO-FISURADO
ACHTA208C	M6 x 45	5	8	45	39	10	10	9	100	41	41	392	329
ACHTA208L	M6 x 60	20	8	45	39	10	10	9	100	41	41	392	329
ACHTA209C	M6 x 45	5	9	45	39	10	10	10	100	41	41	392	329
ACHTA209L	M6 x 60	20	9	45	39	10	10	10	100	41	41	392	329
ACHTA210C	M8 x 60	5	10	60	51	13	20	12	100	54	54	384	600
ACHTA210L	M8 x 80	27	10	60	51	13	20	12	100	54	54	384	600
ACHTA211C	M8 x 60	5	11	60	51	13	20	13	100	54	54	384	600
ACHTA211L	M8 x 80	27	11	60	51	13	20	13	100	54	54	384	600
ACHTA212C	M10 x 70	5	12	75	65	17	35	14	100	65	65	566	794
ACHTA212L	M10 x 100	32	12	75	65	17	35	14	100	65	65	566	794
ACHTA214C	M10 x 70	5	14	75	65	17	35	16	100	65	65	566	794
ACHTA214L	M10 x 100	32	14	75	65	17	35	16	100	65	65	566	794
ACHTA216C	M12 x 80	5	16	80	70	19	50	18	110	74	74	647	974
ACHTA216L	M12 x 110	37	16	80	70	19	50	18	110	74	74	647	974
ACHTA220C	M16 x 110	15	20	105	92	24	140	22	145	97	97	971	2572

CH-8.8

Tornillo hexagonal 8.8. Homologado ETE Opt.7

CÓDIGO	MXL	ESPESOR MÁX. A FIJAR	Ø BROCA	PROFUNDIDAD MÍN. DE TALADRO	PROFUNDIDAD MÍN. DEL ANCLAJE	LLAVE DE INSTALACIÓN	PAR DE APRIETE (NM)	Ø ELEMENTO A FIJAR	MÍN. ESPESOR MATERIAL BASE	DISTANCIA MÍN. AL BORDE "A"	DISTANCIA MÍN. ENTRE EJES "B"	EXTRACCIÓN HORMIGÓN NO-FISURADO	CIZALLADURA HORMIGÓN NO-FISURADO
ACHT8808C	M6 x 45	5	8	45	39	10	10	9	100	41	41	267	392
ACHT8808L	M6 x 60	20	8	45	39	10	10	9	100	41	41	267	392
ACHT8810C	M8 x 60	5	10	60	51	13	20	12	100	54	54	485	604
ACHT8810L	M8 x 80	27	10	60	51	13	20	12	100	54	54	485	604
ACHT8812C	M10 x 70	5	12	75	65	17	35	14	100	65	65	662	794
ACHT8812L	M10 x 100	32	12	75	65	17	35	14	100	65	65	662	794
ACHT8816C	M12 x 80	5	16	80	70	19	50	18	110	74	74	812	974
ACHT8816L	M12 x 110	37	16	80	70	19	50	18	110	74	74	812	974
ACHT8820C	M16 x 110	15	20	105	92	24	140	22	145	97	97	1459	2918

CH-8.8 E

Tornillo hexagonal 8.8 para espesores reducidos

CÓDIGO	MXL	ESPESOR MÁX. A FIJAR	Ø BROCA	PROFUNDIDAD MÍN. DE TALADRO	PROFUNDIDAD MÍN. DEL ANCLAJE	LLAVE DE INSTALACIÓN	PAR DE APRIETE (NM)	Ø ELEMENTO A FIJAR	MÍN. ESPESOR MATERIAL BASE	DISTANCIA MÍN. AL BORDE "A"	DISTANCIA MÍN. ENTRE EJES "B"	EXTRACCIÓN HORMIGÓN NO- FISURADO	CIZALLADURA HORMIGÓN NO- FISURADO
ACHT8808E	M6 x 40	5	8	40	32	10	10	9	70	41	54	215	298
ACHT8810E	M8 x 40	5	10	45	37	13	20	12	70	41	54	249	298

CH-PL

Cabeza plana. Homologado ETE Opt.7. Homologado ETE Opción 7.

CÓDIGO	MXL	ESPESOR MÁX. A FIJAR	Ø BROCA	PROFUNDIDAD MÍN. DE TALADRO	PROFUNDIDAD MÍN. DEL ANCLAJE	LLAVE DE INSTALACIÓN	PAR DE APRIETE (NM)	Ø ELEMENTO A FIJAR	MÍN. ESPESOR MATERIAL BASE	DISTANCIA MÍN. AL BORDE "A"	DISTANCIA MÍN. ENTRE EJES "B"	EXTRACCIÓN HORMIGÓN NO- FISURADO	CIZALLADURA HORMIGÓN NO- FISURADO
ACHTPL08C	M6 x 45	5	8	45	39	4	10	9	100	41	41	267	392
ACHTPL08L	M6 x 60	20	8	45	39	4	10	9	100	41	41	267	392
ACHTPL10C	M8 x 60	5	10	60	51	5	20	12	100	54	54	485	604
ACHTPL10L	M8 x 80	27	10	60	51	5	20	12	100	54	54	485	604
ACHTPL12C	M10 x 70	5	12	75	65	6	35	14	100	65	65	662	794
ACHTPL12L	M10 x 100	32	12	75	65	6	35	14	100	65	65	662	794

CH-INB

Cabeza inviolable cincada. Homologado ETE Opt.7

CÓDIGO	MXL	ESPESOR MÁX. A FIJAR	Ø BROCA	PROFUNDIDAD MÍN. DE TALADRO	PROFUNDIDAD MÍN. DEL ANCLAJE	LLAVE DE INSTALACIÓN	PAR DE APRIETE (NM)	Ø ELEMENTO A FIJAR	MÍN. ESPESOR MATERIAL BASE	DISTANCIA MÍN. AL BORDE "A"	DISTANCIA MÍN. ENTRE EJES "B"	EXTRACCIÓN HORMIGÓN NO- FISURADO	CIZALLADURA HORMIGÓN NO- FISURADO
ACHINB08C	M6 x 45	5	8	45	39	TX40	10	9	100	41	41	267	219
ACHINB08L	M6 x 60	20	8	45	39	TX40	10	9	100	41	41	267	219
ACHINB10C	M8 x 60	5	10	60	51	TX40	20	12	100	54	54	485	399
ACHINB10L	M8 x 80	27	10	60	51	TX40	20	12	100	54	54	485	399

CH-INN

Cabeza inviolable cincada negra. Homologado ETE Opt.7

CÓDIGO	MXL	ESPESOR MÁX. A FIJAR	Ø BROCA	PROFUNDIDAD MÍN. DE TALADRO	PROFUNDIDAD MÍN. DEL ANCLAJE	LLAVE DE INSTALACIÓN	PAR DE APRIETE (NM)	Ø ELEMENTO A FIJAR	MÍN. ESPESOR MATERIAL BASE	DISTANCIA MÍN. AL BORDE "A"	DISTANCIA MÍN. ENTRE EJES "B"	EXTRACCIÓN HORMIGÓN NO- FISURADO	CIZALLADURA HORMIGÓN NO- FISURADO
ACHINN08C	M6 x 45	5	8	45	39	TX40	10	9	100	41	41	267	219
ACHINN08L	M6 x 60	20	8	45	39	TX40	10	9	100	41	41	267	219
ACHINN10C	M8 x 60	5	10	60	51	TX40	20	12	100	54	54	485	399
ACHINN10L	M8 x 80	27	10	60	51	TX40	20	12	100	54	54	485	399

CH-PI

Cabeza plana inoxidable A2. Homologado ETE Opt.7

CÓDIGO	MXL	ESPESOR MÁX. A FIJAR	Ø BROCA	PROFUNDIDAD MÍN. DE TALADRO	PROFUNDIDAD MÍN. DEL ANCLAJE	LLAVE DE INSTALACIÓN	PAR DE APRIETE (NM)	Ø ELEMENTO A FIJAR	MÍN. ESPESOR MATERIAL BASE	DISTANCIA MÍN. AL BORDE "A"	DISTANCIA MÍN. ENTRE EJES "B"	EXTRACCIÓN HORMIGÓN NO- FISURADO	CIZALLADURA HORMIGÓN NO- FISURADO
ACHTPI08C	M6 x 45	5	8	45	39	4	10	9	100	41	41	392	329
ACHTPI08L	M6 x 60	20	8	45	39	4	10	9	100	41	41	392	329
ACHTPI10C	M8 x 60	5	10	60	51	5	20	12	100	54	54	384	600
ACHTPI10L	M8 x 80	27	10	60	51	5	20	12	100	54	54	384	600
ACHTPI12C	M10 x 70	5	12	75	65	6	35	14	100	65	65	566	794
ACHTPI12L	M10 x 100	32	12	75	65	6	35	14	100	65	65	566	794

CH-ES

Espárrago

CÓDIGO	MXL	ESPESOR MÁX. A FIJAR	Ø BROCA	PROFUNDIDAD MÍN. DE TALADRO	PROFUNDIDAD MÍN. DEL ANCLAJE	LLAVE DE INSTALACIÓN	PAR DE APRIETE (NM)	Ø ELEMENTO A FIJAR	MÍN. ESPESOR MATERIAL BASE	DISTANCIA MÍN. AL BORDE "A"	DISTANCIA MÍN. ENTRE EJES "B"	EXTRACCIÓN HORMIGÓN NO- FISURADO	CIZALLADURA HORMIGÓN NO- FISURADO
ACHE08C	M6 x 45	5	8	45	39	10	10	9	100	41	41	267	211
ACHE09C	M6 x 45	5	9	45	39	10	10	10	100	41	41	267	211
ACHE10C	M8 x 60	5	10	60	51	13	20	12	100	54	54	485	384
ACHE10L	M8 x 80	27	10	60	51	13	20	12	105	54	54	485	384
ACHE11C	M8 x 60	5	11	60	51	13	20	13	100	54	54	485	384
ACHE11L	M8 x 80	27	11	60	51	13	20	13	105	54	54	485	384
ACHE12C	M10 x 70	5	12	75	65	17	35	14	100	65	65	662	608
ACHE12L	M10 x 100	32	12	75	65	17	35	14	110	65	65	662	608
ACHE14C	M10 x 70	5	14	75	65	17	35	16	100	65	65	662	608
ACHE14L	M10 x 100	32	14	75	65	17	35	16	100	65	65	662	608

CH-GA

Gancho

CÓDIGO	MXL	ABERTURA GANCHO	Ø BROCA	PROFUNDIDAD MÍN. DE TALADRO	PROFUNDIDAD MÍN. DEL ANCLAJE	LLAVE DE INSTALACIÓN	PAR DE APRIETE (NM)	Ø ELEMENTO A FIJAR	MÍN. ESPESOR MATERIAL BASE	DISTANCIA MÍN. AL BORDE "A"	DISTANCIA MÍN. ENTRE EJES "B"	EXTRACCIÓN HORMIGÓN NO- FISURADO	CIZALLADURA HORMIGÓN NO- FISURADO
ACHG08C	M6 x 45	10	8	45	39	10	10	9	100	41	41	73	-
ACHG09C	M6 x 45	10	9	45	39	10	10	10	100	41	41	73	-
ACHG10C	M8 x 60	13	10	60	51	13	20	12	100	54	54	146	-
ACHG11C	M8 x 60	13	11	60	51	13	20	13	100	54	54	146	-
ACHG12C	M10 x 70	14	12	75	65	17	35	14	100	65	65	243	-
ACHG14C	M10 x 70	14	14	75	65	17	35	16	100	65	65	243	-
ACHG16C	M12 x 80	22	16	80	70	19	50	18	110	74	74	291	-

CH-GE

Gancho espiral

CÓDIGO	MXL	ESPESOR MÁX. A FIJAR	Ø BROCA	PROFUNDIDAD MÍN. DE TALADRO	PROFUNDIDAD MÍN. DEL ANCLAJE	LLAVE DE INSTALACIÓN	PAR DE APRIETE (NM)	Ø ELEMENTO A FIJAR	MÍN. ESPESOR MATERIAL BASE	DISTANCIA MÍN. AL BORDE "A"	DISTANCIA MÍN. ENTRE EJES "B"	EXTRACCIÓN HORMIGÓN NO-FISURADO	CIZALLADURA HORMIGÓN NO-FISURADO
ACHGE10	M8 x 115	-	10	60	51	13	20	12	100	41	41	146	-
ACHGE12	M10 x 135	-	12	80	70	17	35	14	100	54	54	243	-

CH-GF

Gancho forjado

CÓDIGO	MXL	ABERTURA GANCHO	Ø BROCA	PROFUNDIDAD MÍN. DE TALADRO	PROFUNDIDAD MÍN. DEL ANCLAJE	LLAVE DE INSTALACIÓN	PAR DE APRIETE (NM)	Ø ELEMENTO A FIJAR	MÍN. ESPESOR MATERIAL BASE	DISTANCIA MÍN. AL BORDE "A"	DISTANCIA MÍN. ENTRE EJES "B"	EXTRACCIÓN HORMIGÓN NO-FISURADO	CIZALLADURA HORMIGÓN NO-FISURADO
ACHGF008C	M6 x 45	10	8	45	39	10	10	9	100	41	41	80	-
ACHGF010C	M8 x 60	11	10	60	51	13	20	12	100	54	54	155	-
ACHGF012C	M10 x 70	14	12	75	65	17	35	14	100	65	65	243	-

CH-GF A2

Gancho forjado. Inoxidable A2

CÓDIGO	MXL	ABERTURA GANCHO	Ø BROCA	PROFUNDIDAD MÍN. DE TALADRO	PROFUNDIDAD MÍN. DEL ANCLAJE	LLAVE DE INSTALACIÓN	PAR DE APRIETE (NM)	Ø ELEMENTO A FIJAR	MÍN. ESPESOR MATERIAL BASE	DISTANCIA MÍN. AL BORDE "A"	DISTANCIA MÍN. ENTRE EJES "B"	EXTRACCIÓN HORMIGÓN NO-FISURADO	CIZALLADURA HORMIGÓN NO-FISURADO
ACHGA208C	M6 x 45	10	8	45	39	10	10	9	100	41	41	84	-
ACHGA210C	M8 x 60	11	10	60	51	13	20	12	100	54	54	84	-
ACHGA212C	M10 x 70	14	12	75	65	17	35	14	100	65	65	155	-

CH-AR

Argolla

CÓDIGO	MXL	Ø OJO	Ø BROCA	PROFUNDIDAD MÍN. DE TALADRO	PROFUNDIDAD MÍN. DEL ANCLAJE	LLAVE DE INSTALACIÓN	PAR DE APRIETE (NM)	Ø ELEMENTO A FIJAR	MÍN. ESPESOR MATERIAL BASE	DISTANCIA MÍN. AL BORDE "A"	DISTANCIA MÍN. ENTRE EJES "B"	EXTRACCIÓN HORMIGÓN NO-FISURADO	CIZALLADURA HORMIGÓN NO-FISURADO
ACHA08C	M6 x 45	10	8	45	39	10	10	9	100	41	41	73	-
ACHA09C	M6 x 45	10	9	45	39	10	10	10	100	41	41	73	-
ACHA10C	M8 x 60	13	10	60	51	13	20	12	100	54	54	146	-
ACHA11C	M8 x 60	13	11	60	51	13	20	13	100	54	54	146	-
ACHA12C	M10 x 70	14	12	75	65	17	35	14	100	65	65	243	-
ACHA14C	M10 x 70	14	14	75	65	17	35	16	100	65	65	243	-
ACHA16C	M12 x 80	22	16	80	70	19	50	18	110	74	74	291	-

CH-AF

Argolla forjada

CÓDIGO	MXL	Ø OJO	Ø BROCA	PROFUNDIDAD MÍN. DE TALADRO	PROFUNDIDAD MÍN. DEL ANCLAJE	LLAVE DE INSTALACIÓN	PAR DE APRIETE (NM)	Ø ELEMENTO A FIJAR	MÍN. ESPESOR MATERIAL BASE	DISTANCIA MÍN. AL BORDE "A"	DISTANCIA MÍN. ENTRE EJES "B"	EXTRACCIÓN HORMIGÓN NO-FISURADO	CIZALLADURA HORMIGÓN NO-FISURADO
ACHAF008C	M6 x 45	10	8	45	39	10	10	9	100	41	41	204	-
ACHAF010C	M8 x 60	12	10	60	51	13	20	12	100	54	54	485	-
ACHAF012C	M10 x 70	14	12	75	65	17	35	14	100	65	65	662	-

CH-AF A2

Argolla forjada inoxidable A2

CÓDIGO	MXL	Ø OJO	Ø BROCA	PROFUNDIDAD MÍN. DE TALADRO	PROFUNDIDAD MÍN. DEL ANCLAJE	LLAVE DE INSTALACIÓN	PAR DE APRIETE (NM)	Ø ELEMENTO A FIJAR	MÍN. ESPESOR MATERIAL BASE	DISTANCIA MÍN. AL BORDE "A"	DISTANCIA MÍN. ENTRE EJES "B"	EXTRACCIÓN HORMIGÓN NO-FISURADO	CIZALLADURA HORMIGÓN NO-FISURADO
ACHAA208C	M6 x 45	10	8	45	39	10	10	9	100	41	41	164	-
ACHAA210C	M8 x 60	11	10	60	51	13	20	12	100	54	54	384	-
ACHAA212C	M10 x 70	14	12	75	65	17	35	14	100	65	65	566	-

HE

Anclaje hembra con cono interior para grandes cargas

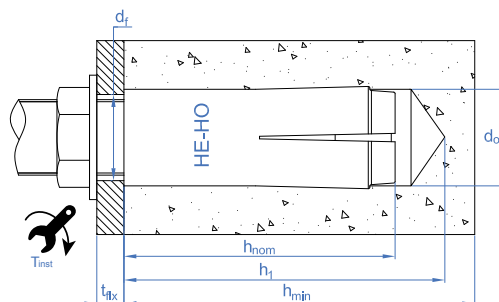
HE-HO

Homologado ETE Opción 7

CÓDIGO	MXL	Ø BROCA	PROFUNDIDAD MÍN. DE TALADRO	PROFUNDIDAD MÍN. DEL ANCLAJE	PAR DE APRIETE (NM)	Ø ELEMENTO A FIJAR	MÍN. ESPESOR MATERIAL BASE	DISTANCIA MÍN. AL BORDE "A"	DISTANCIA MÍN. ENTRE EJES "B"	EXTRACCIÓN HORMIGÓN NO-FISURADO	CIZALLADURA HORMIGÓN NO-FISURADO
HEHOM06	M6	8	27	25	4	7	100	105	60	249	298
HEHOM08	M8	10	33	30	11	9	100	105	60	327	392
HEHOM10	M10	12	43	40	17	12	100	140	80	432	530
HEHOM12	M12	15	54	50	38	14	100	175	100	603	844
HEHOM16	M16	20	70	65	60	18	130	230	130	894	1893
HEHOM20	M20	25	86	80	100	22	160	280	160	1220	2767
HEHOM12D	M12	16	54	50	38	14	100	175	100	603	844

HE-A4

Inoxidable A4. Homologado ETE Aplicaciones no estructurales

CÓDIGO	MXL	Ø BROCA	PROFUNDIDAD MÍN. DE TALADRO	PROFUNDIDAD MÍN. DEL ANCLAJE	PAR DE APRIETE (NM)	Ø ELEMENTO A FIJAR	MÍN. ESPESOR MATERIAL BASE	DISTANCIA MÍN. AL BORDE "A"	DISTANCIA MÍN. ENTRE EJES "B"	EXTRACCIÓN HORMIGÓN NO-FISURADO	CIZALLADURA HORMIGÓN NO-FISURADO
HEA4M06	M6	8	27	25	4	7	80	150	200	87	87
HEA4M08	M8	10	33	30	11	9	80	150	200	121	121
HEA4M10	M10	12	43	40	17	12	80	150	200	121	121
HEA4M12	M12	15	54	50	38	14	100	150	200	225	225
HEA4M16	M16	20	70	65	60	18	130	195	260	433	433
HEA4M20	M20	25	86	80	100	22	160	240	320	572	572

HE-CL

Con collarín. Cincado. Homologado ETE Opt.7 y para aplicaciones no estructurales

CÓDIGO	MXL	Ø BROCA	PROFUNDIDAD MÍN. DE TALADRO	PROFUNDIDAD MÍN. DEL ANCLAJE	PAR DE APRIETE (NM)	Ø ELEMENTO A FIJAR	MÍN. ESPESOR MATERIAL BASE	DISTANCIA MÍN. AL BORDE "A"	DISTANCIA MÍN. ENTRE EJES "B"	EXTRACCIÓN HORMIGÓN NO-FISURADO	CIZALLADURA HORMIGÓN NO-FISURADO
HECLOM06	M6	8	27	25	4	7	100	105	60	249	298
HECLOM08	M8	10	33	30	11	9	100	105	90	327	392
HECLOM10	M10	12	43	40	17	12	100	140	80	432	530
HECLOM12	M12	15	54	50	38	14	100	175	100	603	844
HECLOM16	M16	20	70	65	60	18	130	230	130	894	1893
HECLOM12D	M12	16	54	50	38	14	100	175	160	603	844

HE-C4

Con collarín. Inoxidable A4. Homologado ETE Aplicaciones no estructurales

CÓDIGO	MXL	Ø BROCA	PROFUNDIDAD MÍN. DE TALADRO	PROFUNDIDAD MÍN. DEL ANCLAJE	PAR DE APRIETE (NM)	Ø ELEMENTO A FIJAR	MÍN. ESPESOR MATERIAL BASE	DISTANCIA MÍN. AL BORDE "A"	DISTANCIA MÍN. ENTRE EJES "B"	EXTRACCIÓN HORMIGÓN NO-FISURADO	CIZALLADURA HORMIGÓN NO-FISURADO
HEC4M06	M6	8	27	25	4	7	80	150	200	87	87
HEC4M08	M8	10	33	30	11	9	80	150	200	121	121
HEC4M10	M10	12	43	40	17	12	80	150	200	121	121
HEC4M12	M12	15	54	50	38	14	100	150	200	225	225

HE-HC

Versión corta. Cincado. Homologado ETE Aplicaciones no estructurales

CÓDIGO	MXL	Ø BROCA	PROFUNDIDAD MÍN. DE TALADRO	PROFUNDIDAD MÍN. DEL ANCLAJE	PAR DE APRIETE (NM)	Ø ELEMENTO A FIJAR	MÍN. ESPESOR MATERIAL BASE	DISTANCIA MÍN. AL BORDE "A"	DISTANCIA MÍN. ENTRE EJES "B"	EXTRACCIÓN HORMIGÓN NO-FISURADO	CIZALLADURA HORMIGÓN NO-FISURADO
HEHCM08	M8 x 25	10	28	25	11	9	80	60	75	101	101
HEHCM10	M10 x 25	12	28	25	17	12	80	60	75	162	162
HEHCM12	M12 x 25	15	29	25	38	14	80	60	75	162	162

HE-NO

Cincado

CÓDIGO	MXL	Ø BROCA	PROFUNDIDAD MÍN. DE TALADRO	PROFUNDIDAD MÍN. DEL ANCLAJE	PAR DE APRIETE (NM)	Ø ELEMENTO A FIJAR	MÍN. ESPESOR MATERIAL BASE	DISTANCIA MÍN. AL BORDE "A"	DISTANCIA MÍN. ENTRE EJES "B"	EXTRACCIÓN HORMIGÓN NO-FISURADO	CIZALLADURA HORMIGÓN NO-FISURADO
HENOM06	M6	8	27	25	4	7	100	105	60	175	298
HENOM08	M8	10	33	30	11	9	100	105	90	230	392
HENOM10	M10	12	43	40	17	12	100	140	80	354	530
HENOM12	M12	15	54	50	38	14	100	175	100	494	844
HENOM16	M16	20	70	65	60	18	130	230	130	733	1893
HENOM20	M20	25	86	80	100	22	160	280	160	1000	2767

HE-NS

Inoxidable A4. Homologado ETE Aplicaciones no estructurales

CÓDIGO	MXL	Ø BROCA	PROFUNDIDAD MÍN. DE TALADRO	PROFUNDIDAD MÍN. DEL ANCLAJE	PAR DE APRIETE (NM)	Ø ELEMENTO A FIJAR	MÍN. ESPESOR MATERIAL BASE	DISTANCIA MÍN. AL BORDE "A"	DISTANCIA MÍN. ENTRE EJES "B"	EXTRACCIÓN HORMIGÓN NO-FISURADO	CIZALLADURA HORMIGÓN NO-FISURADO
HENSM08	M8 x 30	10	33	30	11	9	100	105	90	327	392
HENSM10	M10 x 40	12	43	40	17	12	100	140	80	432	530
HENSM12	M12 x 50	15	54	50	38	14	100	175	100	603	844
HENSM16	M16 x 65	20	70	65	60	18	130	230	130	894	1893

HC

Anclaje para losa alveolar. Homologado ETE

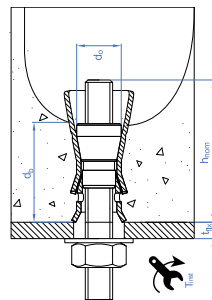

HC

Cápsula

CÓDIGO	MXL	Ø BROCA	PROFUNDIDAD MÍN. DE TALADRO	PAR DE APRIETE (NM)	Ø ELEMENTO A FIJAR	MÍN. ESPESOR MATERIAL BASE	DISTANCIA MÍN. AL BORDE "A"	DISTANCIA MÍN. ENTRE EJES "B"	EXTRACCIÓN HORMIGÓN NO-FISURADO	CIZALLADURA HORMIGÓN NO-FISURADO
HCM06	M6 x 38	10	45	10	7	25	100	60	-	-
HCM08	M8 x 44	12	50	20	9	25	100	70	-	-
HCM10	M10 x 53	16	60	30	12	25	100	80	-	-

TALA

Taco de latón para fijaciones ligeras en materiales macizos

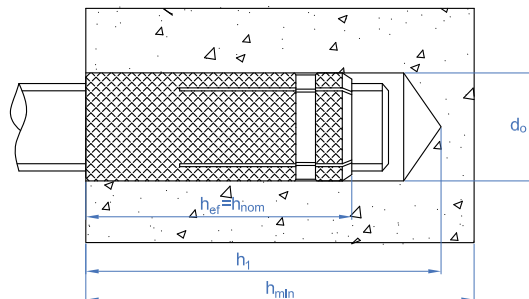

TALA

Taco de latón para fijaciones ligeras en materiales macizos

CÓDIGO	MXL	Ø BROCA	PROFUNDIDAD MÍN. DE TALADRO	MÍN. ESPESOR MATERIAL BASE	DISTANCIA MÍN. AL BORDE "A"	DISTANCIA MÍN. ENTRE EJES "B"	EXTRACCIÓN HORMIGÓN NO-FISURADO
TALA532	W5/32	5	20	25	24	48	60
TALAM04	M4	5	20	25	24	48	60
TALAM05	M5	6	22	30	27	54	70
TALAM06	M6	8	28	35	35	69	100
TALAM08	M8	10	33	40	42	84	150
TALAM10	M10	12	40	45	51	102	210
TALAM12	M12	15	45	50	57	114	320

TA-ME

Taco de expansión metálico

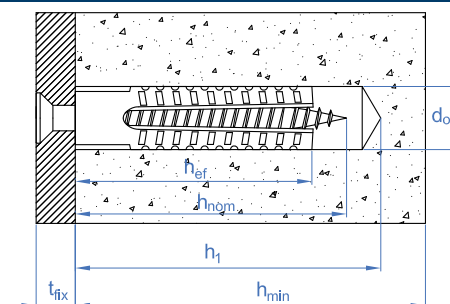

TA-ME

Taco de expansión metálico

CÓDIGO	MXL	Ø BROCA	PROFUNDIDAD MÍN. DE TALADRO	MÍN. ESPESOR MATERIAL BASE	DISTANCIA MÍN. AL BORDE "A"	DISTANCIA MÍN. ENTRE EJES "B"	EXTRACCIÓN HORMIGÓN NO-FISURADO
TAME05030	M5	5	40	60	120	60	20
TAME06032	M6	6	40	60	120	60	22
TAME08038	M8	8	50	70	140	70	40
TAME08060	M8	8	70	120	240	120	47
TAME10060	M10	10	70	120	240	120	52

AN-CU

Anclaje metálico tipo cuña. Homologado ETE

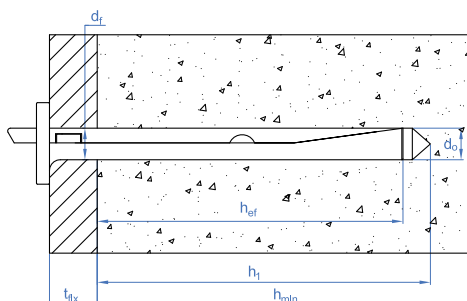

AN-CU

Anclaje metálico tipo cuña

CÓDIGO	MXL	ESPEJOR MÁX. A FIJAR	Ø BROCA	PROFUNDIDAD MÍN. DE TALADRO	Ø ELEMENTO A FIJAR	MÍN. ESPESOR MATERIAL BASE	DISTANCIA MÍN. AL BORDE "A"	DISTANCIA MÍN. ENTRE EJES "B"	EXTRACCIÓN HORMIGÓN NO-FISURADO
ANCU06040	6 x 40	5	6	40	7	80	150	200	120
ANCU06070	6 x 70	35	6	40	7	80	150	200	120

ZA

Anclaje para cargas medias-altas en materiales macizos o huecos

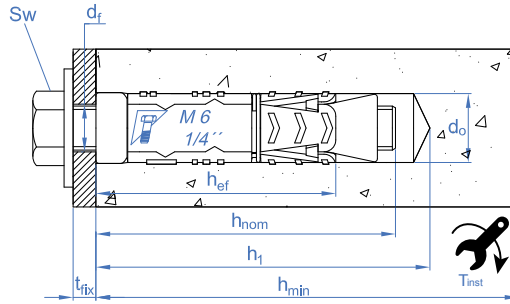

ZA-CA

Cápsula

CÓDIGO	MXL	ESPOSOR MÁX. A FIJAR	Ø BROCA	PROFUNDIDAD MÍN. DE TALADRO	PROFUNDIDAD MÍN. DEL ANCLAJE	PAR DE APRIETE (NM)	Ø ELEMENTO A FIJAR	MÍN. ESPESOR MATERIAL BASE	DISTANCIA MÍN. AL BORDE "A"	DISTANCIA MÍN. ENTRE EJES "B"	EXTRACCIÓN HORMIGÓN NO-FISURADO	CIZALLADURA HORMIGÓN NO-FISURADO
AZAMC06	M6 x 48	-	12	60	48	7	7	100	62	125	513	351
AZAMC08	M8 x 50	-	14	65	50	15	9	100	65	130	561	640
AZAMC10	M10 x 58	-	16	75	58	30	12	102	80	155	725	870
AZAMC12	M12 x 72	-	20	90	72	50	14	122	95	185	865	1473
AZAMC16	M16 x 107	-	25	125	107	120	18	192	145	290	1053	2744

ZA-TO

Tornillo

CÓDIGO	MXL	ESPOSOR MÁX. A FIJAR	Ø BROCA	PROFUNDIDAD MÍN. DE TALADRO	PROFUNDIDAD MÍN. DEL ANCLAJE	LLAVE DE INSTALACIÓN	PAR DE APRIETE (NM)	Ø ELEMENTO A FIJAR	MÍN. ESPESOR MATERIAL BASE	DISTANCIA MÍN. AL BORDE "A"	DISTANCIA MÍN. ENTRE EJES "B"	EXTRACCIÓN HORMIGÓN NO-FISURADO	CIZALLADURA HORMIGÓN NO-FISURADO
AZAMT06	M6 x 50	1	12	60	48	10	7	7	100	62	125	513	351
AZAMT08	M8 x 60	10	14	65	50	13	15	9	100	65	130	561	640
AZAMT10	M10 x 80	20	16	75	58	17	30	12	102	80	155	725	870
AZAMT12	M12 x 100	25	20	90	72	19	50	14	122	95	185	865	1473
AZAMT16	M16 x 140	30	25	125	107	24	120	18	192	145	290	1053	2744

ZA-TL

Tornillo largo

CÓDIGO	MXL	ESPOSOR MÁX. A FIJAR	Ø BROCA	PROFUNDIDAD MÍN. DE TALADRO	PROFUNDIDAD MÍN. DEL ANCLAJE	LLAVE DE INSTALACIÓN	PAR DE APRIETE (NM)	Ø ELEMENTO A FIJAR	MÍN. ESPESOR MATERIAL BASE	DISTANCIA MÍN. AL BORDE "A"	DISTANCIA MÍN. ENTRE EJES "B"	EXTRACCIÓN HORMIGÓN NO-FISURADO	CIZALLADURA HORMIGÓN NO-FISURADO
ZT06L10	M6 x 60	10	12	60	48	10	7	7	100	62	125	513	351
ZT06L30	M6 x 80	30	12	60	48	10	7	7	100	62	125	513	351
ZT08L15	M8 x 70	15	14	65	50	13	15	9	100	65	130	561	640
ZT08L35	M8 x 90	35	14	65	50	13	15	9	100	65	130	561	640
ZT08L45	M8 x 100	45	14	65	50	13	15	9	100	65	130	561	640
ZT10L10	M10 x 70	10	16	75	58	17	30	12	102	80	155	725	870
ZT10L30	M10 x 90	30	16	75	58	17	30	12	102	80	155	725	870
ZT10L50	M10 x 110	50	16	75	58	17	30	12	102	80	155	725	870
ZT10L80	M10 x 140	80	16	75	58	17	30	12	102	80	155	725	870
ZT12L15	M12 x 90	15	20	90	72	19	50	14	122	95	185	865	1473
ZT12L45	M12 x 120	45	20	90	72	19	50	14	122	95	185	865	1473
ZT12L65	M12 x 140	65	20	90	72	19	50	14	122	95	185	865	1473

ZA-PR

Tornillo largo + prolongador

CÓDIGO	MXL	ESPOSOR MÁX. A FIJAR	Ø BROCA	PROFUNDIDAD MÍN. DE TALADRO	PROFUNDIDAD MÍN. DEL ANCLAJE	LLAVE DE INSTALACIÓN	PAR DE APRIETE (NM)	Ø ELEMENTO A FIJAR	MÍN. ESPESOR MATERIAL BASE	DISTANCIA MÍN. AL BORDE "A"	DISTANCIA MÍN. ENTRE EJES "B"	EXTRACCIÓN HORMIGÓN NO-FISURADO	CIZALLADURA HORMIGÓN NO-FISURADO
ZP06C40	M6 x 90	40	12	60	48	10	7	14	100	62	125	415	246
ZP08C15	M8 x 70	15	14	65	50	13	7	16	100	65	130	561	448
ZP08C45	M8 x 100	45	14	65	50	13	30	16	100	80	130	561	448
ZP10C50	M10 x 110	50	16	75	58	17	30	18	102	80	155	725	709
ZP10C80	M10 x 140	80	16	75	58	17	30	18	102	80	155	725	709
ZP12C15	M12 x 90	15	20	90	72	19	50	22	122	95	185	865	1031
ZP12C65	M12 x 140	65	20	90	72	19	50	22	122	95	185	865	1031

ZA-ES

Espárrago

CÓDIGO	MXL	ESPOSOR MÁX. A FIJAR	Ø BROCA	PROFUNDIDAD MÍN. DE TALADRO	PROFUNDIDAD MÍN. DEL ANCLAJE	LLAVE DE INSTALACIÓN	PAR DE APRIETE (NM)	Ø ELEMENTO A FIJAR	MÍN. ESPESOR MATERIAL BASE	DISTANCIA MÍN. AL BORDE "A"	DISTANCIA MÍN. ENTRE EJES "B"	EXTRACCIÓN HORMIGÓN NO-FISURADO	CIZALLADURA HORMIGÓN NO-FISURADO
AZAME06	M6 x 60	1	12	60	48	10	7	7	100	62	125	415	246
AZAME08	M8 x 70	10	14	65	50	13	15	9	100	65	130	561	448
AZAME10	M10 x 100	30	16	75	58	17	30	12	102	80	155	725	709
AZAME12	M12 x 120	30	20	90	72	19	50	14	122	95	185	865	1031
AZAME16	M16 x 140	12	25	125	107	24	120	18	192	145	290	1053	1920

ZA-GA

Gancho

CÓDIGO	MXL	ABERTURA GANCHO	Ø BROCA	PROFUNDIDAD MÍN. DE TALADRO	PROFUNDIDAD MÍN. DEL ANCLAJE	LLAVE DE INSTALACIÓN	PAR DE APRIETE (NM)	Ø ELEMENTO A FIJAR	MÍN. ESPESOR MATERIAL BASE	DISTANCIA MÍN. AL BORDE "A"	DISTANCIA MÍN. ENTRE EJES "B"	EXTRACCIÓN HORMIGÓN NO-FISURADO	CIZALLADURA HORMIGÓN NO-FISURADO
AZAMG06	M6 x 48	10	12	60	48	10	7	7	100	62	125	73	-
AZAMG08	M8 x 50	13	14	65	50	13	15	9	100	65	130	146	-
AZAMG10	M10 x 58	14	16	75	58	17	30	12	102	80	155	243	-
AZAMG12	M12 x 72	22	20	90	72	19	50	14	122	95	185	291	-

ZA-GF

Gancho forjado

CÓDIGO	MXL	ABERTURA GANCHO	Ø BROCA	PROFUNDIDAD MÍN. DE TALADRO	PROFUNDIDAD MÍN. DEL ANCLAJE	LLAVE DE INSTALACIÓN	PAR DE APRIETE (NM)	Ø ELEMENTO A FIJAR	MÍN. ESPESOR MATERIAL BASE	DISTANCIA MÍN. AL BORDE "A"	DISTANCIA MÍN. ENTRE EJES "B"	EXTRACCIÓN HORMIGÓN NO-FISURADO	CIZALLADURA HORMIGÓN NO-FISURADO
AZAMGF006	M6 x 60	10	12	60	48	10	7	7	100	62	125	80	-
AZAMGF008	M8 x 70	11	14	65	50	13	15	9	100	65	130	155	-
AZAMGF010	M10 x 100	14	16	75	58	17	30	12	102	80	155	243	-
AZAMGF012	M12 x 120	18	20	90	72	19	50	14	122	95	185	396	-

ZA-AR

Argolla

CÓDIGO	MXL	Ø OJO	Ø BROCA	PROFUNDIDAD MÍN. DE TALADRO	PROFUNDIDAD MÍN. DEL ANCLAJE	LLAVE DE INSTALACIÓN	PAR DE APRIETE (NM)	Ø ELEMENTO A FIJAR	MÍN. ESPESOR MATERIAL BASE	DISTANCIA MÍN. AL BORDE "A"	DISTANCIA MÍN. ENTRE EJES "B"	EXTRACCIÓN HORMIGÓN NO-FISURADO	CIZALLADURA HORMIGÓN NO-FISURADO
AZAMA06	M6 x 48	10	12	60	48	10	7	7	100	62	125	73	-
AZAMA08	M8 x 50	13	14	65	50	13	15	9	100	65	130	146	-
AZAMA10	M10 x 58	14	16	75	58	17	30	12	102	80	155	243	-
AZAMA12	M12 x 72	22	20	90	72	19	50	14	122	95	185	291	-

ZA-AF

Argolla forjada

CÓDIGO	MXL	Ø OJO	Ø BROCA	PROFUNDIDAD MÍN. DE TALADRO	PROFUNDIDAD MÍN. DEL ANCLAJE	LLAVE DE INSTALACIÓN	PAR DE APRIETE (NM)	Ø ELEMENTO A FIJAR	MÍN. ESPESOR MATERIAL BASE	DISTANCIA MÍN. AL BORDE "A"	DISTANCIA MÍN. ENTRE EJES "B"	EXTRACCIÓN HORMIGÓN NO-FISURADO	CIZALLADURA HORMIGÓN NO-FISURADO
AZAMAF006	M6 x 48	10	12	60	48	10	7	7	100	62	125	204	-
AZAMAF008	M8 x 50	12	14	65	50	13	15	9	100	65	130	555	-
AZAMAF010	M10 x 58	14	16	75	58	17	30	12	102	80	155	725	-
AZAMAF012	M12 x 72	17	20	90	72	19	50	14	122	95	185	820	-

AC

Anclaje de acero con aletas para cargas altas

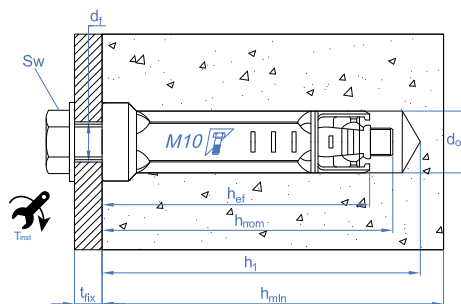

AC-CA

Cápsula

CÓDIGO	MXL	ESPEOR MÁX. A FIJAR	Ø BROCA	PROFUNDIDAD MÍN. DE TALADRO	PROFUNDIDAD MÍN. DEL ANCLAJE	PAR DE APRIETE (NM)	Ø ELEMENTO A FIJAR	MÍN. ESPESOR MATERIAL BASE	DISTANCIA MÍN. AL BORDE "A"	DISTANCIA MÍN. ENTRE EJES "B"	EXTRACCIÓN HORMIGÓN NO-FISURADO	CIZALLADURA HORMIGÓN NO-FISURADO
AACCA06	M6 Tornillo 6.8	-	10	45	40	10	7	100	60	120	92	351
AACCA08	M8 Tornillo 6.8	-	14	60	50	25	9	100	75	150	98	640
AACCA10	M10 Tornillo 6.8	-	16	70	60	50	12	120	90	180	441	1014
AACCA12	M12 Tornillo 6.8	-	20	90	80	85	14	160	120	240	571	1473
AACCA16	M16 Tornillo 6.8	-	25	110	100	120	18	200	150	300	698	2744

AC-CI

Cápsula. Inoxidable A4

CÓDIGO	MXL	ESPEOR MÁX. A FIJAR	Ø BROCA	PROFUNDIDAD MÍN. DE TALADRO	PROFUNDIDAD MÍN. DEL ANCLAJE	PAR DE APRIETE (NM)	Ø ELEMENTO A FIJAR	MÍN. ESPESOR MATERIAL BASE	DISTANCIA MÍN. AL BORDE "A"	DISTANCIA MÍN. ENTRE EJES "B"	EXTRACCIÓN HORMIGÓN NO-FISURADO	CIZALLADURA HORMIGÓN NO-FISURADO
AACCI06	M6 x 40	-	10	45	40	10	7	100	60	120	92	329
AACCI08	M8 x 50	-	14	60	50	25	9	100	75	150	98	600
AACCI10	M10 x 60	-	16	70	60	50	12	120	90	180	441	950
AACCI12	M12 x 80	-	20	90	80	85	14	160	120	240	571	1381

AC-TO

Tornillo 6.8

CÓDIGO	MXL	ESPEOR MÁX. A FIJAR	Ø BROCA	PROFUNDIDAD MÍN. DE TALADRO	PROFUNDIDAD MÍN. DEL ANCLAJE	LLAVE DE INSTALACIÓN	PAR DE APRIETE (NM)	Ø ELEMENTO A FIJAR	MÍN. ESPESOR MATERIAL BASE	DISTANCIA MÍN. AL BORDE "A"	DISTANCIA MÍN. ENTRE EJES "B"	EXTRACCIÓN HORMIGÓN NO-FISURADO	CIZALLADURA HORMIGÓN NO-FISURADO
AACTO06	M6 x 50	8	10	45	40	10	10	7	100	60	120	92	351
AACTO08	M8 x 60	8	14	60	50	13	25	9	100	75	150	98	640
AACTO10	M10 x 70	8	16	70	60	17	50	12	120	90	180	441	1014
AACTO12	M12 x 125	18	20	90	80	19	85	14	160	120	240	571	1473
AACTO16	M16 x 125	17	25	110	100	24	120	18	200	150	300	698	2744

AC-ES Espárrago													
CÓDIGO	MXL	ESPEJOR MÁX. A FIJAR	Ø BROCA	PROFUNDIDAD MÍN. DE TALADRO	PROFUNDIDAD MÍN. DEL ANCLAJE	LLAVE DE INSTALACIÓN	PAR DE APRIETE (NM)	Ø ELEMENTO A FIJAR	MÍN. ESPESOR MATERIAL BASE	DISTANCIA MÍN. AL BORDE "A"	DISTANCIA MÍN. ENTRE EJES "B"	EXTRACCIÓN HORMIGÓN NO-FISURADO	CIZALLADURA HORMIGÓN NO-FISURADO
AACES06	M6 x 60	8	10	45	40	10	10	7	100	60	120	92	246
AACES08	M8 x 70	8	14	60	50	13	25	9	100	75	150	98	448
AACES10	M10 x 80	8	16	70	60	17	50	12	120	90	180	441	709
AACES12	M12 x 115	18	20	90	80	19	85	14	160	120	240	571	1031

AC-GA Gancho													
CÓDIGO	MXL	ABERTURA GANCHO	Ø BROCA	PROFUNDIDAD MÍN. DE TALADRO	PROFUNDIDAD MÍN. DEL ANCLAJE	LLAVE DE INSTALACIÓN	PAR DE APRIETE (NM)	Ø ELEMENTO A FIJAR	MÍN. ESPESOR MATERIAL BASE	DISTANCIA MÍN. AL BORDE "A"	DISTANCIA MÍN. ENTRE EJES "B"	EXTRACCIÓN HORMIGÓN NO-FISURADO	CIZALLADURA HORMIGÓN NO-FISURADO
AACGA06	M6 x 55	10	10	45	40	10	10	7	100	60	120	80	-
AACGA08	M8 x 60	11	14	60	50	13	25	9	100	75	150	98	-
AACGA10	M10 x 73	14	16	70	60	17	50	12	120	90	180	243	-
AACGA12	M12 x 90	18	20	90	80	19	85	14	160	120	240	396	-

AC-AR Argolla													
CÓDIGO	MXL	Ø OJO	Ø BROCA	PROFUNDIDAD MÍN. DE TALADRO	PROFUNDIDAD MÍN. DEL ANCLAJE	LLAVE DE INSTALACIÓN	PAR DE APRIETE (NM)	Ø ELEMENTO A FIJAR	MÍN. ESPESOR MATERIAL BASE	DISTANCIA MÍN. AL BORDE "A"	DISTANCIA MÍN. ENTRE EJES "B"	EXTRACCIÓN HORMIGÓN NO-FISURADO	CIZALLADURA HORMIGÓN NO-FISURADO
AACAR06	M6 x 55	10	10	45	40	10	10	7	100	60	120	92	-
AACAR08	M8 x 60	12	14	60	50	13	25	9	100	75	150	98	-
AACAR10	M10 x 73	14	16	70	60	17	50	12	120	90	180	441	-
AACAR12	M12 x 90	17	20	90	80	19	85	14	160	120	240	571	-

HI Anclaje antigiro para cargas altas

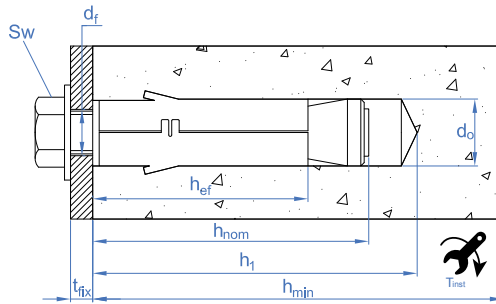

HI-CA Cápsula													
CÓDIGO	MXL	ESPEJOR MÁX. A FIJAR	Ø BROCA	PROFUNDIDAD MÍN. DE TALADRO	PROFUNDIDAD MÍN. DEL ANCLAJE	PAR DE APRIETE (NM)	Ø ELEMENTO A FIJAR	MÍN. ESPESOR MATERIAL BASE	DISTANCIA MÍN. AL BORDE "A"	DISTANCIA MÍN. ENTRE EJES "B"	EXTRACCIÓN HORMIGÓN NO-FISURADO	CIZALLADURA HORMIGÓN NO-FISURADO	
AHICA0645	M6 x 45	-	12	60	45	10	7	100	45	90	41	392	
AHICA0855	M8 x 55	-	14	65	50	20	9	100	55	105	163	494	
AHICA1065	M10 x 65	-	16	75	60	40	12	100	70	135	237	721	
AHICA1275	M12 x 75	-	20	90	70	65	14	110	85	165	332	1841	
AHICA1690	M16 x 90	-	24	105	100	150	18	140	105	210	424	2797	

HI-CI Cápsula. Inoxidable A2													
CÓDIGO	MXL	ESPEJOR MÁX. A FIJAR	Ø BROCA	PROFUNDIDAD MÍN. DE TALADRO	PROFUNDIDAD MÍN. DEL ANCLAJE	PAR DE APRIETE (NM)	Ø ELEMENTO A FIJAR	MÍN. ESPESOR MATERIAL BASE	DISTANCIA MÍN. AL BORDE "A"	DISTANCIA MÍN. ENTRE EJES "B"	EXTRACCIÓN HORMIGÓN NO-FISURADO	CIZALLADURA HORMIGÓN NO-FISURADO	
AHICIO645	M6 x 60	-	12	60	45	10	7	100	45	90	360	329	
AHICIO855	M8 x 65	-	14	65	50	20	9	100	55	105	542	600	
AHICIO65	M10 x 81	-	16	75	60	40	12	100	70	135	704	844	

HI-TO Tornillo 8.8													
CÓDIGO	MXL	ESPEJOR MÁX. A FIJAR	Ø BROCA	PROFUNDIDAD MÍN. DE TALADRO	PROFUNDIDAD MÍN. DEL ANCLAJE	LLAVE DE INSTALACIÓN	PAR DE APRIETE (NM)	Ø ELEMENTO A FIJAR	MÍN. ESPESOR MATERIAL BASE	DISTANCIA MÍN. AL BORDE "A"	DISTANCIA MÍN. ENTRE EJES "B"	EXTRACCIÓN HORMIGÓN NO-FISURADO	CIZALLADURA HORMIGÓN NO-FISURADO
AHITO0645	M6 x 50	8	12	60	45	10	10	7	100	45	90	41	392
AHITO0855	M8 x 60	15	14	65	50	13	20	9	100	55	105	163	494
AHITO1065	M10 x 80	23	16	75	60	17	40	12	100	70	135	237	721
AHITO1275	M12 x 100	30	20	90	70	19	65	14	110	85	165	332	1841
AHITO1690	M16 x 110	17	24	105	100	24	150	18	140	105	210	424	2797

HI-GA Gancho													
CÓDIGO	MXL	ABERTURA GANCHO	Ø BROCA	PROFUNDIDAD MÍN. DE TALADRO	PROFUNDIDAD MÍN. DEL ANCLAJE	LLAVE DE INSTALACIÓN	PAR DE APRIETE (NM)	MÍN. ESPESOR MATERIAL BASE	DISTANCIA MÍN. AL BORDE "A"	DISTANCIA MÍN. ENTRE EJES "B"	EXTRACCIÓN HORMIGÓN NO-FISURADO	CIZALLADURA HORMIGÓN NO-FISURADO	
AHIGA0645	M6 x 55	10	12	60	45	10	10	100	45	90	41	-	
AHIGA0855	M8 x 60	11	14	65	50	13	20	100	55	105	155	-	
AHIGA1065	M10 x 73	14	16	75	60	17	40	100	70	135	237	-	
AHIGA1275	M12 x 90	18	20	90	70	19	65	110	85	165	332	-	
AHIGA1690	M16 x 110	19	24	105	100	24	150	140	105	210	424	-	

HI-AR

Argolla

CÓDIGO	MXL	Ø OJO	Ø BROCA	PROFUNDIDAD MIN. DE TALADRO	PROFUNDIDAD MIN. DEL ANCLAJE	LLAVE DE INSTALACIÓN	PAR DE APRIETE (NM)	MÍN. ESPESOR MATERIAL BASE	DISTANCIA MIN. AL BORDE "A"	DISTANCIA MIN. ENTRE EJES "B"	EXTRACCIÓN HORMIGÓN NO-FISURADO	CIZALLADURA HORMIGÓN NO-FISURADO
AHIAR0645	M6 x 60	10	12	60	45	10	10	100	45	90	41	-
AHIAR0855	M8 x 65	12	14	65	50	13	20	100	55	105	163	-
AHIAR1065	M10 x 81	14	16	75	60	17	40	100	70	135	237	-
AHIAR1275	M12 x 98	17	20	90	70	19	65	110	85	165	332	-
AHIAR1690	M16 x 120	23	24	105	100	24	150	140	105	210	424	-

EPS

Anclaje metálico para fijar marcos de puertas y ventanas

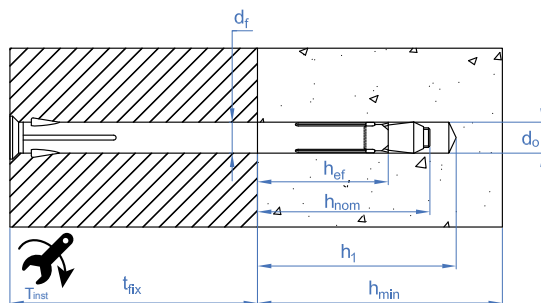

EPS

Anclaje metálico para fijar marcos de puertas y ventanas

CÓDIGO	MXL	ESPEJOR MÁX. A FIJAR	Ø BROCA	PROFUNDIDAD MIN. DE TALADRO	PROFUNDIDAD MIN. DEL ANCLAJE	PAR DE APRIETE (NM)	Ø ELEMENTO A FIJAR	MÍN. ESPESOR MATERIAL BASE	EXTRACCIÓN HORMIGÓN NO-FISURADO	CIZALLADURA HORMIGÓN FISURADO
EPS6072	M6 x 72	40	10	60	40	4	10	70	170	-
EPS6092	M6 x 92	60	10	60	40	4	10	70	170	-
EPS6112	M6 x 112	80	10	60	40	4	10	70	170	-
EPS6132	M6 x 132	100	10	60	40	4	10	70	170	-
EPS6152	M6 x 152	120	10	60	40	4	10	70	170	-
EPS6182	M6 x 182	150	10	60	40	4	10	70	170	-

TRA

Taco elástico para la fijación de rastreles

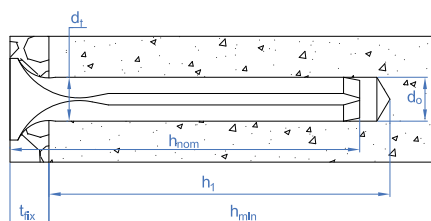

TRA

Taco elástico para la fijación de rastreles

CÓDIGO	MXL	ESPEJOR MÁX. A FIJAR	Ø BROCA	PROFUNDIDAD MIN. DE TALADRO	PROFUNDIDAD MIN. DEL ANCLAJE	Ø ELEMENTO A FIJAR	MÍN. ESPESOR MATERIAL BASE	EXTRACCIÓN HORMIGÓN NO-FISURADO	CIZALLADURA HORMIGÓN FISURADO
TRA6050	6 x 50	20	6	40	30	6	35	40	-
TRA6060	6 x 60	30	6	40	30	6	35	40	-
TRA6080	6 x 80	50	6	40	30	6	35	40	-
TRA8070	8 x 70	30	8	50	40	8	45	50	-
TRA8090	8 x 90	50	8	50	40	8	45	50	-
TRA8110	8 x 110	70	8	50	40	8	45	50	-
TRA8130	8 x 130	90	8	50	40	8	45	50	-
TRA8150	8 x 150	110	8	50	40	8	45	50	-

INSTALACIÓN EN HORMIGÓN

1 TALADRAR

Comprobar que:

- El hormigón esté bien compactado y sin poros significativos.
- El producto sea admisible en taladros secos, húmedos o inundados.
- La temperatura de los cartuchos sea la adecuada (revisar tabla).
- La temperatura del material base sea la adecuada (revisar tabla).

Taladro en posición percusión o martillo.

Taladrar a diámetro y profundidad especificados en la ficha de cada producto.

2 - 6 SOPLAR Y LIMPIAR

Limpiar el agujero de restos de polvo y fragmentos del taladrado según indicaciones del gráfico. Utilizar la bomba de aire y el cepillo. En caso de que el producto no sea admisible para taladros inundados y el taladro contenga agua en su interior, ésta debe ser eliminada antes de inyectar la resina.

A - B* - C ABRIR CARTUCHO

Roscar la cánula en el cartucho y colocar el conjunto en la pistola de aplicación. Apretar el gatillo hasta conseguir que el mortero salga por la punta de un color gris uniforme, sin irisaciones (indica mezcla incorrecta); desechar las dos primeras emboladas de cada cartucho, que no serán utilizadas para fijaciones. * En los cartuchos de 300 ml cortar el extremo de la bolsa, por detrás de la grapa de cierre. ** Valido solo para cartuchos de 300 y 410 ml. Para MOPURE y MOPUR3 consultar ficha técnica.

7 APLICAR MORTERO

Insertar la cánula hasta el fondo del taladro y aplicar mortero; ir retirando la cánula lentamente, asegurándose de que no quedan burbujas de aire.

Rellenar el taladro hasta $\frac{1}{2}$ a $\frac{3}{4}$ de su profundidad.

En caso de que no se use completamente el cartucho dejar la cánula montada. Cambiarla solo en el caso de que se vaya a utilizar de nuevo transcurrido el tiempo de manipulación, volviendo a desechar las dos primeras emboladas.

8 INSTALAR

Introducir el espárrago a instalar con la mano, roscando ligeramente, hasta el fondo del taladro, asegurándose de que el mortero cubre los filetes de rosca. La introducción del anclaje debe realizarse dentro del tiempo de manipulación. Se debe observar rebose del mortero en la boca del taladro para asegurar que el hueco entre el espárrago y el taladro queda relleno completamente.

9 APLICAR PAR DE APRIETE INSTALAR

Una vez transcurrido el tiempo de curado aplicar el par de apriete, no excediendo el valor indicado en la tabla.

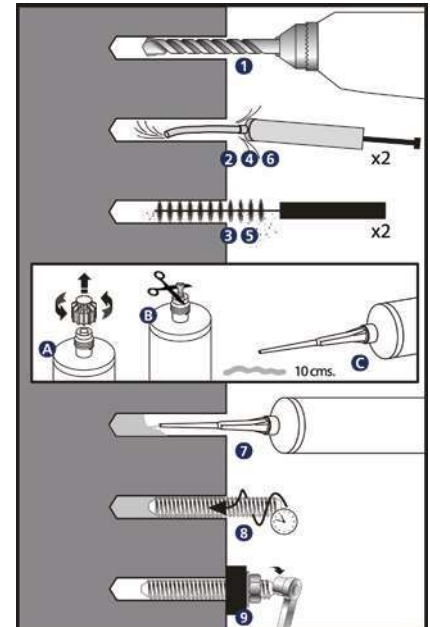

INSTALACIÓN EN LADRILLOS

1 TALADRAR

Comprobar que el ladrillo esté en buen estado y sin poros significativos.

- El producto sea admisible en taladros secos, húmedos o inundados.
- El que la temperatura de los cartuchos sea la adecuada (revisar tabla).
- El que la temperatura del material base sea la adecuada (revisar tabla).

Taladro en posición de rotación.

Taladrar a diámetro y profundidad especificados en la ficha de cada producto

2 - 3 SOPLAR Y LIMPIAR

Limpiar el agujero de restos de polvo y fragmentos del taladrado según indicaciones del gráfico.

Si el taladro tiene agua en su interior ésta debe ser eliminada antes de inyectar la resina.

4 COLOCAR TAMIZ (S)

Insertar el tamiz de plástico o metálico en el taladro de forma que quede rasante con la superficie del material base.

A - B* - C ABRIR CARTUCHO**

Roscar la cánula en el cartucho y colocar el conjunto en la pistola de aplicación. Apretar el gatillo hasta conseguir que el mortero salga por la punta de un color gris uniforme, sin irisaciones (indica mezcla incorrecta); desechar las dos primeras emboladas de cada cartucho, que no serán utilizadas para fijaciones. *En los cartuchos de 170 ml y 300 ml cortar el extremo de la bolsa, por detrás de la grapa de cierre.

** Valido solo para cartuchos de 300 y 410 ml. Para MOPURE y MOPUR3 consultar ficha técnica..

5 APLICAR MORTERO

Insertar la cánula hasta el fondo del tamiz y aplicar mortero; ir retirando la cánula lentamente, asegurándose de que no quedan burbujas de aire. Rellenar el tamiz por completo.

En caso de que no se use completamente el cartucho dejar la cánula montada. Cambiarla solo en el caso de que se vaya a utilizar de nuevo transcurrido el tiempo de manipulación, volviendo a desechar las dos primeras emboladas.

6 INSTALAR

Introducir el espárrago a instalar con la mano, roscando ligeramente, hasta el fondo del taladro, asegurándose de que el mortero cubre los filetes de rosca. La introducción del anclaje debe realizarse dentro del tiempo de manipulación. Se debe observar rebose del mortero en la boca del tamiz para asegurar que el hueco entre el espárrago y el taladro queda relleno completamente.

7 APLICAR PAR DE APRIETE

Una vez transcurrido el tiempo de curado aplicar el par de apriete, no excediendo el valor indicado en la tabla

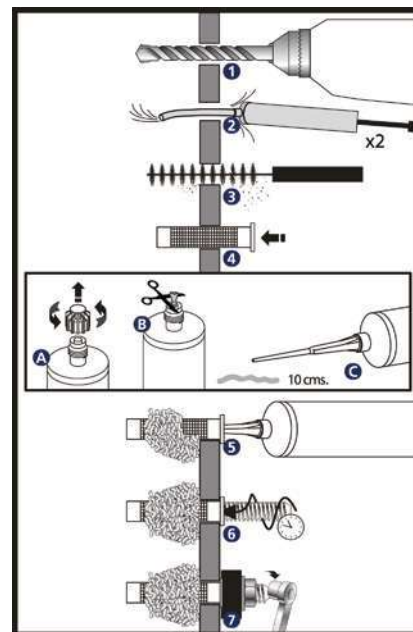

INSTALACIÓN CON TAMIZ PLÁSTICO

MÉTRICA	M8	M10	M12
DIÁMETRO EXTERIOR DEL TAMIZ	15	15	20
LONGITUD DEL AGUJERO	90	90	90
TAMIZ PLÁSTICO	MOTN15085	MOTN15085	MOTN20085

INSTALACIÓN CON TAMIZ ROSCADO

MÉTRICA	M8	M10	M12
DIÁMETRO EXTERIOR DEL TAMIZ	15	20	20
LONGITUD DEL AGUJERO	90	90	90
TAMIZ ROSCADO	MOTRO08	MOTRO10	MOTRO12
TAMIZ PLÁSTICO	MOTN15085	MOTN20085	MOTN20085

TIEMPOS MANIPULACIÓN/CURADO

		0/5	5/10	10/15	15/20	20/25	25,30	30/35	35/40	+40
MO-P	MANIPULACIÓN	18	12	6	6	4	3	2	1,5	1,5
	CURADO	120	120	80	80	40	30	20	15	10
MO-PS	MANIPULACIÓN	18	10	6	6	5	4	4	--	--
	CURADO	145	145	85	85	40	35	35	--	--
MO-PSP	MANIPULACIÓN	18	10	6	6	5	4	4	--	--
	CURADO	145	145	85	85	40	35	35	--	--
MO-V	MANIPULACIÓN	18	12	6	6	4	3	2	1,5	1,5
	CURADO	120	120	80	80	40	30	20	15	10
MO-VS	MANIPULACIÓN	18	10	6	6	5	4	4	--	--
	CURADO	145	145	85	85	50	40	35	--	--
MO-H	MANIPULACIÓN	--	10	8	6	5	4	--	--	--
	CURADO	--	145	85	75	50	40	--	--	--
MO-HW	MANIPULACIÓN	10	5	5	5	100 s	--	--	--	--
	CURADO	75	50	50	50	20	--	--	--	--
MOPU-RE	MANIPULACIÓN	--	20	20	15	11	8	6	4	3
	CURADO	--	1440	720	480	420	360	300	240	180
MO-PUR3	MANIPULACIÓN	300	150	40	25	18	12	8	6	--
	CURADO	1440	1440	1080	720	480	360	240	120	--
MO-PU	MANIPULACIÓN	18	12	6	6	4	3	2	1,5	1,5
	CURADO	120	120	80	80	40	30	20	15	10

Minutos

ANFA

Anclaje para andamios y fachadas

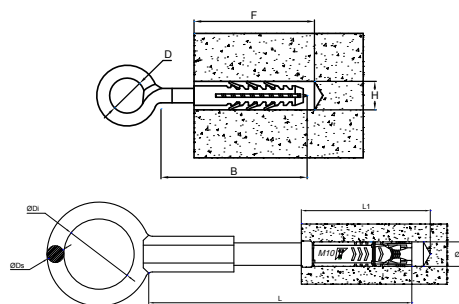

AN-23

Diámetro de ojo 23 mm

CÓDIGO	MXL	Ø BROCA	PROFUNDIDAD MÍN. DE TALADRO	PROFUNDIDAD MÍN. DEL ANCLAJE	MÍN. ESPESOR MATERIAL BASE	Ø OJO	EXTRACCIÓN HORMIGÓN NO-FISURADO
ANFA2309	12 x 90	14 o 16	100	90	130	23	119
ANFA2312	12 x 120	14 o 16	130	120	160	23	119
ANFA2316	12 x 160	14 o 16	170	160	200	23	119
ANFA2319	12 x 190	14 o 16	200	190	230	23	119
ANFA2323	12 x 230	14 o 16	240	230	270	23	119
ANFA2330	12 x 300	14 o 16	310	300	340	23	119
ANFA2335	12 x 350	14 o 16	360	350	390	23	119

AN-51

Diámetro de ojo 51 mm

CÓDIGO	MXL	Ø BROCA	PROFUNDIDAD MÍN. DE TALADRO	PROFUNDIDAD MÍN. DEL ANCLAJE	MÍN. ESPESOR MATERIAL BASE	Ø OJO	EXTRACCIÓN HORMIGÓN NO-FISURADO
ANFA5114	12 x 140	14 o 16	150	140	180	51	119
ANFA5116	12 x 160	14 o 16	170	160	200	51	119
ANFA5120	12 x 200	14 o 16	210	200	240	51	119
ANFA5124	12 x 240	14 o 16	250	240	280	51	119

AN-50 CT

Diámetro de ojo 50 mm + cápsula Zamak M10

CÓDIGO	MXL	PROFUNDIDAD MÍN. DE TALADRO	MÍN. ESPESOR MATERIAL BASE	Ø OJO	EXTRACCIÓN HORMIGÓN NO-FISURADO
ANFAZ5021	M10 x 210	120	160	50	200

CA-QU

Resina de epoxi-acrilato, cuarzo y catalizador. Homologado ETE Opt. 8

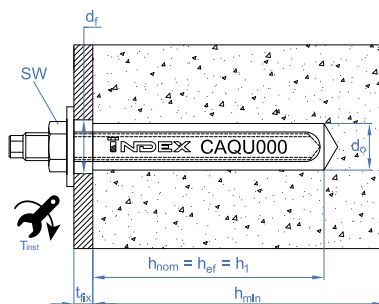

CA-QU

Resina de epoxi-acrilato, cuarzo y catalizador. Homologado ETE Opción 8

CÓDIGO	MXL	ESPEJOR MÁX. A FIJAR	Ø BROCA	PROFUNDIDAD MÍN. DE TALADRO	PROFUNDIDAD MÍN. DEL ANCLAJE	LLAVE DE INSTALACIÓN	PAR DE APRIETE (NM)	Ø ELEMENTO A FIJAR	MÍN. ESPESOR MATERIAL BASE	DISTANCIA MÍN. AL BORDE "A"	DISTANCIA MÍN. ENTRE EJES "B"	EXTRACCIÓN HORMIGÓN NO-FISURADO	CIZALLADURA HORMIGÓN NO-FISURADO
CAQU008	8 Ø9 / 17	17	10	80	80	13	10	9	110	120	240	809	524
CAQU010	10 Ø11 / 25	25	12	90	90	17	20	12	120	90	180	1214	815
CAQU012	12 Ø13 / 32	32	14	110	110	19	40	14	140	110	220	1618	1223
CAQU016	16 Ø17 / 44	44	18	125	125	24	80	18	160	125	250	2023	2272
CAQU020	20 Ø22 / 66	66	25	170	170	30	120	22	220	170	340	3034	3553
CAQU024	24 Ø24 / 62	62	28	210	210	36	180	26	260	210	420	3641	5126
CAQU030	30 Ø33 / 22	22	35	280	280	46	400	33	360	280	560	5461	8496

T-NUX

Taco de nylon universal de alto rendimiento

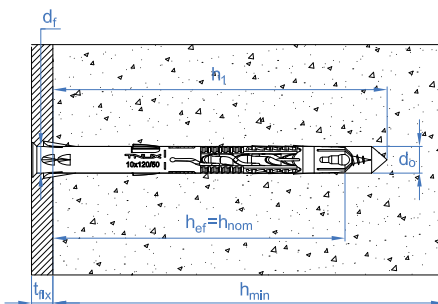

T-NUX A

Cabeza avellanada. Cincado. Homologado ETE

CÓDIGO	MXL	ESPEJOR MÁX. A FIJAR	Ø BROCA	PROFUNDIDAD MÍN. DE TALADRO	PROFUNDIDAD MÍN. DEL ANCLAJE	LLAVE DE INSTALACIÓN	Ø ELEMENTO A FIJAR	MÍN. ESPESOR MATERIAL BASE	DISTANCIA MÍN. AL BORDE "A"	DISTANCIA MÍN. ENTRE EJES "B"	EXTRACCIÓN HORMIGÓN NO-FISURADO	CIZALLADURA HORMIGÓN NO-FISURADO
TNUXA08060	8 x 60	10	8	70	50	TX30	8 - 8,5	100	60	100	141	263
TNUXA08080	8 x 80	10	8	90	70	TX30	8 - 8,5	100	60	100	141	263
TNUXA08100	8 x 100	30	8	90	70	TX30	8 - 8,5	100	60	100	141	263
TNUXA08120	8 x 120	50	8	90	70	TX30	8 - 8,5	100	60	100	141	263
TNUXA10060	10 x 60	10	10	70	50	TX40	10 - 11	100	60	100	202	364
TNUXA10080	10 x 80	10	10	90	70	TX40	10 - 11	100	70	100	202	364
TNUXA10100	10 x 100	30	10	90	70	TX40	10 - 11	100	70	100	202	364
TNUXA10120	10 x 120	50	10	90	70	TX40	10 - 11	100	70	100	202	364
TNUXA10140	10 x 140	70	10	90	70	TX40	10 - 11	100	70	100	202	364
TNUXA10160	10 x 160	90	10	90	70	TX40	10 - 11	100	70	100	202	364
TNUXA10180	10 x 180	110	10	90	70	TX40	10 - 11	100	70	100	202	364
TNUXA10200	10 x 200	130	10	90	70	TX40	10 - 11	100	70	100	202	364
TNUXA10230	10 x 230	160	10	90	70	TX40	10 - 11	100	70	100	202	364

T-NUX A A4

Inoxidable A4. Cabeza avellanada. Homologado ETE

CÓDIGO	MXL	ESPEJOR MÁX. A FIJAR	Ø BROCA	PROFUNDIDAD MIN. DE TALADRO	PROFUNDIDAD MIN. DEL ANCLAJE	LLAVE DE INSTALACIÓN	Ø ELEMENTO A FIJAR	MÍN. ESPEJOR MATERIAL BASE	DISTANCIA MIN. AL BORDE "A"	DISTANCIA MIN. ENTRE EJES "B"	EXTRACCIÓN HORMIGÓN NO-FISURADO	CIZALLADURA HORMIGÓN NO-FISURADO
TNXA408080	8 x 80	10	8	90	70	TX30	8 - 8,5	100	60	100	141	307
TNXA408100	8 x 100	30	8	90	70	TX30	8 - 8,5	100	60	100	141	307
TNXA408120	8 x 120	50	8	90	70	TX30	8 - 8,5	100	60	100	141	307
TNXA410080	10 x 80	10	10	90	70	TX40	10 - 11	100	70	100	202	425
TNXA410100	10 x 100	30	10	90	70	TX40	10 - 11	100	70	100	202	425
TNXA410120	10 x 120	50	10	90	70	TX40	10 - 11	100	70	100	202	425
TNXA410140	10 x 140	70	10	90	70	TX40	10 - 11	100	70	100	202	425

T-NUX E

Cabeza hexagonal. Cincado. Homologado ETE

CÓDIGO	MXL	ESPEJOR MÁX. A FIJAR	Ø BROCA	PROFUNDIDAD MIN. DE TALADRO	PROFUNDIDAD MIN. DEL ANCLAJE	LLAVE DE INSTALACIÓN	Ø ELEMENTO A FIJAR	MÍN. ESPEJOR MATERIAL BASE	DISTANCIA MIN. AL BORDE "A"	DISTANCIA MIN. ENTRE EJES "B"	EXTRACCIÓN HORMIGÓN NO-FISURADO	CIZALLADURA HORMIGÓN NO-FISURADO
TNUXE08060	8 x 60	10	8	90	50	SW10/TX30	8 - 8,5	100	60	100	141	263
TNUXE08080	8 x 80	10	8	90	70	SW10/TX30	8 - 8,5	100	60	100	141	263
TNUXE08100	8 x 100	30	8	90	70	SW10/TX30	8 - 8,5	100	60	100	141	263
TNUXE08120	8 x 120	50	8	90	70	SW10/TX30	8 - 8,5	100	60	100	141	263
TNUXE10060	10 x 60	10	10	90	50	SW13/TX40	10 - 11	100	70	100	202	364
TNUXE10080	10 x 80	10	10	90	70	SW13/TX40	10 - 11	100	70	100	202	364
TNUXE10100	10 x 100	30	10	90	70	SW13/TX40	10 - 11	100	70	100	202	364
TNUXE10120	10 x 120	50	10	90	70	SW13/TX40	10 - 11	100	70	100	202	364
TNUXE10140	10 x 140	70	10	90	70	SW13/TX40	10 - 11	100	70	100	202	364
TNUXE10160	10 x 160	90	10	90	70	SW13/TX40	10 - 11	100	70	100	202	364
TNUXE10180	10 x 180	110	10	90	70	SW13/TX40	10 - 11	100	70	100	202	364
TNUXE10200	10 x 200	130	10	90	70	SW13/TX40	10 - 11	100	70	100	202	364
TNUXE10230	10 x 230	160	10	90	70	SW13/TX40	10 - 11	100	70	100	202	364

T-NUX E A4

Inoxidable A4. Cabeza hexagonal. Homologado ETE

CÓDIGO	MXL	ESPEJOR MÁX. A FIJAR	Ø BROCA	PROFUNDIDAD MIN. DE TALADRO	PROFUNDIDAD MIN. DEL ANCLAJE	LLAVE DE INSTALACIÓN	Ø ELEMENTO A FIJAR	MÍN. ESPEJOR MATERIAL BASE	DISTANCIA MIN. AL BORDE "A"	DISTANCIA MIN. ENTRE EJES "B"	EXTRACCIÓN HORMIGÓN NO-FISURADO	CIZALLADURA HORMIGÓN NO-FISURADO
TNXE408080	8 x 80	10	8	90	70	SW10/TX30	8 - 8,5	100	60	100	141	307
TNXE408100	8 x 100	30	8	90	70	SW10/TX30	8 - 8,5	100	60	100	141	307
TNXE410080	10 x 80	10	10	90	70	SW13/TX40	10 - 11	100	70	100	202	425
TNXE410100	10 x 100	30	10	90	70	SW13/TX40	10 - 11	100	70	100	202	425
TNXE410120	10 x 120	50	10	90	70	SW13/TX40	10 - 11	100	70	100	202	425
TNXE410140	10 x 140	70	10	90	70	SW13/TX40	10 - 11	100	70	100	202	425

T-NUX T

Cabeza Truss inviolable. Cincado. Homologado ETE

CÓDIGO	MXL	ESPEJOR MÁX. A FIJAR	Ø BROCA	PROFUNDIDAD MIN. DE TALADRO	PROFUNDIDAD MIN. DEL ANCLAJE	LLAVE DE INSTALACIÓN	Ø ELEMENTO A FIJAR	MÍN. ESPEJOR MATERIAL BASE	DISTANCIA MIN. AL BORDE "A"	DISTANCIA MIN. ENTRE EJES "B"	EXTRACCIÓN HORMIGÓN NO-FISURADO	CIZALLADURA HORMIGÓN NO-FISURADO
TNUXT10080	10 x 80	10	10	90	50	TX40	10 - 11	100	70	100	202	425
TNUXT10100	10 x 100	30	10	90	70	TX40	10 - 11	100	70	100	202	425
TNUXT10120	10 x 120	50	10	90	70	TX40	10 - 11	100	70	100	202	425
TNUXT10140	10 x 140	70	10	90	70	TX40	10 - 11	100	70	100	202	425
TNUXT10160	10 x 160	90	10	90	70	TX40	10 - 11	100	70	100	202	425

T-FUX E

Taco cabeza cilíndrica. Tornillo cabeza hexagonal. Cincado. Homologado ETE

CÓDIGO	MXL	ESPEJOR MÁX. A FIJAR	Ø BROCA	PROFUNDIDAD MIN. DE TALADRO	PROFUNDIDAD MIN. DEL ANCLAJE	LLAVE DE INSTALACIÓN	Ø ELEMENTO A FIJAR	MÍN. ESPEJOR MATERIAL BASE	DISTANCIA MIN. AL BORDE "A"	DISTANCIA MIN. ENTRE EJES "B"	EXTRACCIÓN HORMIGÓN NO-FISURADO	CIZALLADURA HORMIGÓN NO-FISURADO
TFUXE10080	10 x 80	10	10	90	70	SW13/TX40	10 - 11	100	70	100	202	425
TFUXE10100	10 x 100	30	10	90	70	SW13/TX40	10 - 11	100	70	100	202	425
TFUXE10120	10 x 120	50	10	90	70	SW13/TX40	10 - 11	100	70	100	202	425

TCA

Taco clavable poliamida 6.6

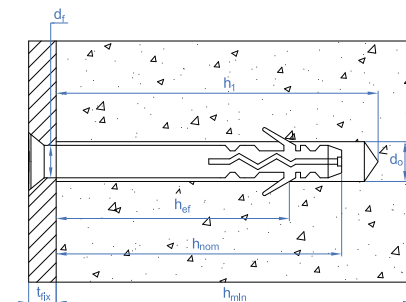

TC-6A

Taco de 6 alas con tornillo avellanado

CÓDIGO	MXL	ESPEJOR MÁX. A FIJAR	Ø BROCA	PROFUNDIDAD MIN. DE TALADRO	Nº HUELLA	EXTRACCIÓN HORMIGÓN NO-FISURADO	CIZALLADURA HORMIGÓN NO-FISURADO	EXTRACCIÓN LADRILLO MACIZO	EXTRACCIÓN LADRILLO HUECO
TC6A08080	8 x 80	15	8	70	TX30	64	37	37	18
TC6A08100	8 x 100	35	8	70	TX30	64	37	37	18

CÓDIGO	MXL	ESPEJOR MÁX. A FIJAR	Ø BROCA	PROFUNDIDAD MÍN. DE TALADRO	Nº HUELLA	EXTRACCIÓN HORMIGÓN NO-FISURADO	CIZALLADURA HORMIGÓN NO-FISURADO	EXTRACCIÓN LADRILLO MACIZO	EXTRACCIÓN LADRILLO HUECO
TC6A08120	8 x 120	55	8	70	TX30	64	37	37	18
TC6A10100	10 x 100	25	10	80	TX40	109	55	53	26
TC6A10120	10 x 120	40	10	80	TX40	109	55	53	26
TC6A10140	10 x 140	60	10	80	TX40	109	55	53	26
TC6A10160	10 x 160	85	10	80	TX40	109	55	53	26
TC6A10200	10 x 200	125	10	80	TX40	109	55	53	26

TC-6E

Taco de 6 alas con tornillo hexagonal

CÓDIGO	MXL	ESPEJOR MÁX. A FIJAR	Ø BROCA	PROFUNDIDAD MÍN. DE TALADRO	Nº HUELLA	EXTRACCIÓN HORMIGÓN NO-FISURADO	CIZALLADURA HORMIGÓN NO-FISURADO	EXTRACCIÓN LADRILLO MACIZO	EXTRACCIÓN LADRILLO HUECO
TC6E08080	8 x 80	15	8	70	10	64	37	37	18
TC6E08100	8 x 100	35	8	70	10	64	37	37	18
TC6E08120	8 x 120	55	8	70	10	64	37	37	18
TC6E10100	10 x 100	25	10	80	13	109	55	53	26
TC6E10120	10 x 120	40	10	80	13	109	55	53	26
TC6E10140	10 x 140	60	10	80	13	109	55	53	26
TC6E10160	10 x 160	85	10	80	13	109	55	53	26
TC6E10200	10 x 200	125	10	80	13	109	55	53	26

TC-2A

Taco de 2 alas con tornillo avellanado

CÓDIGO	MXL	ESPEJOR MÁX. A FIJAR	Ø BROCA	PROFUNDIDAD MÍN. DE TALADRO	Nº HUELLA	EXTRACCIÓN HORMIGÓN NO-FISURADO	CIZALLADURA HORMIGÓN NO-FISURADO	EXTRACCIÓN LADRILLO MACIZO
TC2A06060	6 x 60	30	6	35	2	34	28	10
TC2A08060	8 x 60	20	8	45	3	34	37	19
TC2A08080	8 x 80	40	8	45	3	40	37	19
TC2A08100	8 x 100	60	8	45	3	40	37	19
TC2A08120	8 x 120	80	8	45	3	40	37	19
TC2A10065	10 x 65	20	10	50	4	45	55	22
TC2A10080	10 x 80	35	10	50	4	45	55	22
TC2A10100	10 x 100	55	10	50	4	45	55	22
TC2A10115	10 x 115	70	10	50	4	45	55	22
TC2A10135	10 x 135	90	10	50	4	45	55	22
TC2A10160	10 x 160	115	10	50	4	45	55	22

TC-SP

Taco clavable de alta expansión

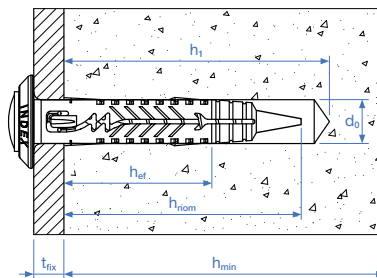

TC-SP

Taco con cabeza avellanada

CÓDIGO	MXL	ESPEJOR MÁX. A FIJAR	Ø BROCA	PROFUNDIDAD MÍN. DE TALADRO	Nº HUELLA	EXTRACCIÓN HORMIGÓN NO-FISURADO	EXTRACCIÓN LADRILLO MACIZO
TCSP05027	5 x 27	5	5	25		17	5
TCSP06032	6 x 32	5	6	30		26	7
TCSP06040	6 x 40	10	6	30		26	7

TC

Taco clavable de poliamida 6.6, premontado con tornillo rosca-arpón

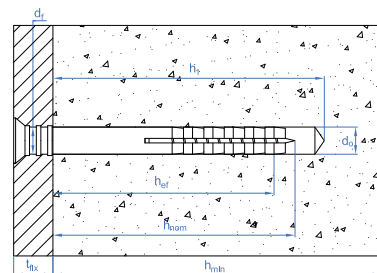

TC-CA

Taco con cabeza avellanada

CÓDIGO	MXL	ESPEJOR MÁX. A FIJAR	Ø BROCA	PROFUNDIDAD MÍN. DE TALADRO	Nº HUELLA	EXTRACCIÓN HORMIGÓN NO-FISURADO	CIZALLADURA HORMIGÓN NO-FISURADO	EXTRACCIÓN LADRILLO MACIZO
TCCA05025	5 x 25	5	5	30	PZ2	13	20	3
TCCA05030	5 x 30	5	5	30	PZ2	13	20	3
TCCA05035	5 x 35	10	5	30	PZ2	13	20	3

CÓDIGO	MXL	ESPESOR MÁX. A FIJAR	Ø BROCA	PROFUNDIDAD MÍN. DE TALADRO	Nº HUELLA	EXTRACCIÓN HORMIGÓN NO-FISURADO	CIZALLADURA HORMIGÓN NO-FISURADO	EXTRACCIÓN LADRILLO MACIZO
TCCA05050	5 x 50	25	5	30	PZ2	13	20	3
TCCA06035	6 x 35	10	6	35	PZ2	18	26	4
TCCA06040	6 x 40	10	6	35	PZ2	18	26	4
TCCA06050	6 x 50	20	6	35	PZ2	18	26	4
TCCA06060	6 x 60	30	6	35	PZ2	18	26	4
TCCA06070	6 x 70	40	6	35	PZ2	18	26	4
TCCA06080	6 x 80	50	6	35	PZ2	18	26	4
TCCA08060	8 x 60	20	8	45	PZ3	29	30	7
TCCA08080	8 x 80	40	8	45	PZ3	29	30	7
TCCA08100	8 x 100	60	8	45	PZ3	29	30	7
TCCA08120	8 x 120	80	8	45	PZ3	29	30	7
TCCA08140	8 x 135	100	8	45	PZ3	29	30	7

TC-A2

Taco con cabeza avellanada y tornillo inoxidable A2

CÓDIGO	MXL	ESPESOR MÁX. A FIJAR	Ø BROCA	PROFUNDIDAD MÍN. DE TALADRO	Nº HUELLA	EXTRACCIÓN HORMIGÓN NO-FISURADO	CIZALLADURA HORMIGÓN NO-FISURADO	EXTRACCIÓN LADRILLO MACIZO
TCA205030	5 x 30	5	5	30	PZ2	13	20	3
TCA206040	6 x 40	10	6	35	PZ2	18	26	4
TCA206060	6 x 60	30	6	35	PZ2	18	26	4
TCA208060	8 x 60	20	8	45	PZ3	29	30	7
TCA208080	8 x 80	40	8	45	PZ3	29	30	7
TCA208100	8 x 100	60	8	45	PZ3	29	30	7

TC-CC

Taco con cabeza cilíndrica

CÓDIGO	MXL	ESPESOR MÁX. A FIJAR	Ø BROCA	PROFUNDIDAD MÍN. DE TALADRO	Nº HUELLA	EXTRACCIÓN HORMIGÓN NO-FISURADO	CIZALLADURA HORMIGÓN NO-FISURADO	EXTRACCIÓN LADRILLO MACIZO
TCCC05025	5 x 25	5	5	30	PZ2	13	20	3
TCCC05030	5 x 30	5	5	30	PZ2	13	20	3
TCCC05035	5 x 35	10	5	30	PZ2	13	20	3
TCCC05050	5 x 50	25	5	30	PZ2	13	20	3
TCCC06035	6 x 35	10	6	35	PZ2	18	26	4
TCCC06040	6 x 40	15	6	35	PZ2	18	26	4
TCCC06050	6 x 50	25	6	35	PZ2	18	26	4
TCCC06060	6 x 60	35	6	35	PZ2	18	26	4
TCCC06070	6 x 70	45	6	35	PZ2	18	26	4
TCCC06080	6 x 80	55	6	35	PZ2	18	26	4
TCCC08060	8 x 60	20	8	45	PZ3	18	30	7
TCCC08080	8 x 80	40	8	45	PZ3	29	30	7
TCCC08100	8 x 100	60	8	45	PZ3	29	30	7
TCCC08120	8 x 120	80	8	45	PZ3	29	30	7
TCCC08140	8 x 135	100	8	45	PZ3	29	30	7

AI5

Taco de fijación de paneles aislantes

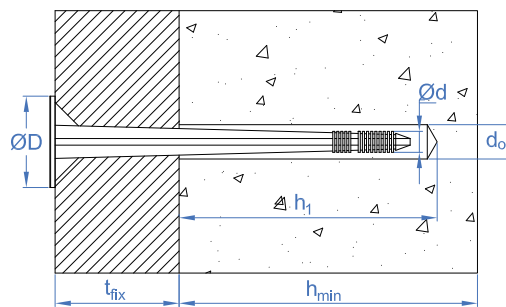

AI5-C

Taco con clavo

CÓDIGO	MXL	MÉTRICA	LONGITUD	Ø BROCA	MÍN. ESPESOR MATERIAL BASE	PROFUNDIDAD MÍN. DE TALADRO	PROFUNDIDAD MÍN. DEL ANCLAJE	ESPESOR MÁX. A FIJAR	DISTANCIA MÍN. AL BORDE "A"	DISTANCIA MÍN. ENTRE EJES "B"	ØD(MM)	EXTRACCIÓN HORMIGÓN NO-FISURADO	EXTRACCIÓN LADRILLO HUECO	EXTRACCIÓN LADRILLO MACIZO	EXTRACCIÓN HORMIGÓN FISURADO
AI5C10070	10 x 70	10	70	10	100	50	40	10-20	100	100	60	32	3	30	32
AI5C10090	10 x 90	10	90	10	100	50	40	30-40	100	100	60	32	3	30	32
AI5C10100	10 x 100	10	100	10	100	50	40	40-50	100	100	60	32	3	30	32
AI5C10110	10 x 110	10	110	10	100	50	40	50-60	100	100	60	32	3	30	32
AI5C10120	10 x 120	10	120	10	100	50	40	60-70	100	100	60	32	3	30	32
AI5C10130	10 x 130	10	130	10	100	50	40	70-80	100	100	60	32	3	30	32
AI5C10140	10 x 140	10	140	10	100	50	40	80-90	100	100	60	32	3	30	32
AI5C10160	10 x 160	10	160	10	100	50	40	100-110	100	100	60	32	3	30	32
AI5C10180	10 x 180	10	180	10	100	50	40	120-130	100	100	60	32	3	30	32
AI5C10200	10 x 200	10	200	10	100	50	40	140-150	100	100	60	32	3	30	32

CÓDIGO	MXL	MÉTRICA	LONGITUD	Ø BROCA	MÍN. ESPESOR MATERIAL BASE	PROFUNDIDAD MÍN. DE TALADRO	PROFUNDIDAD MÍN. DEL ANCLAJE	ESPESOR MÁX. A FIJAR	DISTANCIA MIN. AL BORDE "A"	DISTANCIA MIN. ENTRE EJES "B"	Ø(D)(MM)	EXTRACCIÓN HORMIGÓN NO-FISURADO	EXTRACCIÓN LADRILLO HUECO	EXTRACCIÓN LADRILLO MACIZO	EXTRACCIÓN HORMIGÓN FISURADO
AISC10220	10 x 220	10	220	10	100	50	40	150-170	100	100	60	32	3	30	32
AISC10260	10 x 260	10	260	10	100	50	40	200-210	100	100	60	32	3	30	32

AIS-S

Clavo metálico con tapón plástico

CÓDIGO	MXL	MÉTRICA	LONGITUD	Ø BROCA	MÍN. ESPESOR MATERIAL BASE	PROFUNDIDAD MÍN. DE TALADRO	PROFUNDIDAD MÍN. DEL ANCLAJE	ESPESOR MÁX. A FIJAR	DISTANCIA MIN. AL BORDE "A"	DISTANCIA MIN. ENTRE EJES "B"	Ø(D)(MM)	EXTRACCIÓN HORMIGÓN NO-FISURADO	EXTRACCIÓN LADRILLO HUECO	EXTRACCIÓN LADRILLO MACIZO	EXTRACCIÓN HORMIGÓN FISURADO
AISS10070	10 x 70	10	70	10	100	50	40	10-20	100	100	60	22	3	18	22
AISS10090	10 x 90	10	90	10	100	50	40	30-40	100	100	60	22	3	18	22
AISS10100	10 x 100	10	100	10	100	50	40	40-50	100	100	60	22	3	18	22
AISS10120	10 x 120	10	120	10	100	50	40	60-70	100	100	60	22	3	18	22
AISS10140	10 x 140	10	140	10	100	50	40	80-90	100	100	60	22	3	18	22
AISS10160	10 x 160	10	160	10	100	50	40	100-110	100	100	60	22	3	18	22
AISS10180	10 x 180	10	180	10	100	50	40	120-130	100	100	60	22	3	18	22
AISS10200	10 x 200	10	200	10	100	50	40	140-150	100	100	60	22	3	18	22
AISS10220	10 x 220	10	220	10	100	50	40	150-170	100	100	60	22	3	18	22
AISS10260	10 x 260	10	260	10	100	50	40	200-210	100	100	60	22	3	18	22

AIS

Taco

CÓDIGO	MXL	ESPESOR MÁX. A FIJAR	Ø BROCA	PROFUNDIDAD MÍN. DE TALADRO	PROFUNDIDAD MIN. DEL ANCLAJE	Ø ARANDELA	EXTRACCIÓN HORMIGÓN NO-FISURADO
AIS08080	8 x 80	20 - 50	8	30	30	35	1
AIS08100	8 x 100	50 - 70	8	30	30	35	1
AIS08120	8 x 120	70 - 90	8	30	30	35	1
AIS08140	8 x 140	90 - 110	8	30	30	35	1

AIS-R

Rosetón

CÓDIGO	MXL	Ø(D)(MM)	D
AISR140	Ø140	140	11

AIS-W

Rosetón para uso con tornillo

CÓDIGO	MXL	Ø(D)(MM)	D
AISW060	Ø60	60	6

AIS-M

Taco metálico

CÓDIGO	MXL	MÉTRICA	LONGITUD	Ø BROCA	MÍN. ESPESOR MATERIAL BASE	PROFUNDIDAD MÍN. DE TALADRO	PROFUNDIDAD MIN. DEL ANCLAJE	ESPESOR MÁX. A FIJAR	DISTANCIA MIN. AL BORDE "A"	DISTANCIA MIN. ENTRE EJES "B"	Ø(D)(MM)
AISM08090	8 x 90	8	90	8	100	50	40	50	100	100	35
AISM08110	8 x 110	8	110	8	100	50	40	70	100	100	35
AISM08120	8 x 120	8	120	8	100	50	40	80	100	100	35
AISM08140	8 x 140	8	140	8	100	50	40	100	100	100	35
AISM08170	8 x 170	8	170	8	100	50	40	130	100	100	35
AISM08200	8 x 200	8	200	8	100	50	40	160	100	100	35
AISM08250	8 x 250	8	250	8	100	50	40	210	100	100	35
AISM08300	8 x 300	8	300	8	100	50	40	260	100	100	35

AIS-AM

Arandela para taco metálico

CÓDIGO	MXL	Ø(D)(MM)	L1	D
AISAM085	Ø85	85	0,5	9

TE

Anclaje espiral

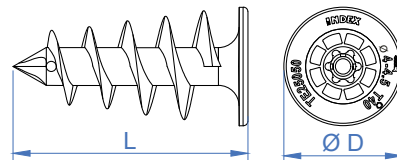

TE

CÓDIGO	MXL	LONGITUD	Ø(D)(MM)
TE25050	25 x 50	50	25
TE25090	25 x 90	90	25

TN4S

Taco de nylon anudable de 4 segmentos para todo tipo de materiales

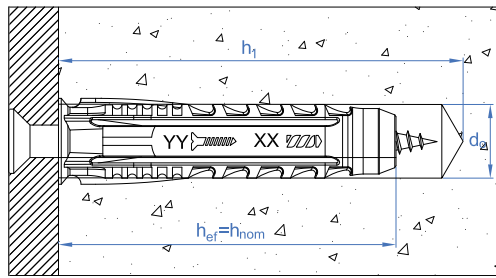

TN4S

Taco

CÓDIGO	MXL	Ø BROCA	PROFUNDIDAD MÍN. DE TALADRO	PROFUNDIDAD MÍN. DEL ANCLAJE	MÍN. ESPESOR MATERIAL BASE	EXTRACCIÓN HORMIGÓN NO-FISURADO	EXTRACCIÓN LADRILLO MACIZO	EXTRACCIÓN LADRILLO HUECO	MEDIDA TORNILLO
TN4S05	5 x 25	5	30	25	35	15	7	4	TPPO 2,5-4
TN4S06	6 x 30	6	40	30	45	15	7	4	TPPO 3,5-4
TN4S08	8 x 40	8	50	40	55	40	16	8	TPPO 4,5, TB 5-6
TN4S10	10 x 50	10	60	50	65	116	23	11	TB 6-8
TN4S12	12 x 60	12	70	60	75	108	40	20	TB 8-10
TN4S14	14 x 70	14	80	70	85	193	125	63	TB 10-12

TN4S-L

Taco largo

CÓDIGO	MXL	Ø BROCA	PROFUNDIDAD MÍN. DE TALADRO	PROFUNDIDAD MÍN. DEL ANCLAJE	MÍN. ESPESOR MATERIAL BASE	EXTRACCIÓN HORMIGÓN NO-FISURADO	EXTRACCIÓN LADRILLO MACIZO	EXTRACCIÓN LADRILLO HUECO	MEDIDA TORNILLO
TN4S06L	6 x 45	6	55	45	60	30	6	6	TPPO 3,5-4
TN4S08L	8 x 60	8	70	60	75	80	12	12	TPPO 4,5, TB 5-6
TN4S10L	10 x 80	10	90	80	95	240	16	16	TB 6-8

MEDU

Taco universal con collarín y forma de nudo

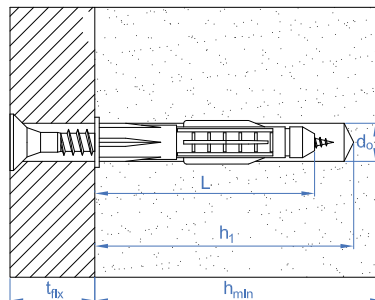

MEDU

Polipropileno

CÓDIGO	MXL	Ø BROCA	PROFUNDIDAD MÍN. DE TALADRO	MÍN. ESPESOR MATERIAL BASE	EXTRACCIÓN HORMIGÓN NO-FISURADO	EXTRACCIÓN LADRILLO MACIZO	EXTRACCIÓN LADRILLO HUECO
MEDUB06	6 x 35	6	45	65	8	5	4
MEDUB07	8 x 42	8	50	70	12	5	4
MEDUB08	8 x 50	8	60	80	24	5	4
MEDUB10	10 x 60	10	75	95	70	7	5

TACON

Taco de nylon

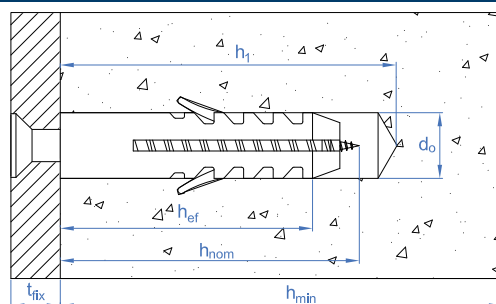

TACON/TACOL/TACOL-A Taco

CÓDIGO	MXL	Ø BROCA	PROFUNDIDAD MÍN. DE TALADRO	PROFUNDIDAD MÍN. DEL ANCLAJE	MÍN. ESPESOR MATERIAL BASE	EXTRACCIÓN HORMIGÓN NO-FISURADO	EXTRACCIÓN LADRILLO MACIZO	MEDIDA TORNILLO
TACON04	4 x 20	4	25	20	30	6	4	TPPO 2,5-3
TACON05/TACOL05/	5 x 25	5	35	25	40	7	5	TPPO 2,5-4

CÓDIGO	MXL	Ø BROCA	PROFUNDIDAD MÍN. DE TALADRO	PROFUNDIDAD MÍN. DEL ANCLAJE	MÍN. ESPESOR MATERIAL BASE	EXTRACCIÓN HORMIGÓN NO-FISURADO	EXTRACCIÓN LADRILLO MACIZO	MEDIDA TORNILLO
TACON06/TACOL06/TACOLA06	6 x 30	6	40	30	45	10	5	TPPO 3,5-4
TACON07	7 x 30	7	45	30	45	11	6	TPPO 4-4,5
TACON08/TACOL08	8 x 40	8	50	40	55	12	11	TPPO 4,5, TB 5-6
TACON10/TACOL10	10 x 50	10	60	50	70	61	16	TB 6-8
TACON12/TACOL12	12 x 60	12	70	60	80	76	28	TB 8-10
TACON14	14 x 70	14	80	70	95	167	88	TB 10-12
TACON16	16 x 80	16	90	80	100	240	100	TB 12-14

IPA

Taco de nylon para ladrillos huecos y materiales macizos

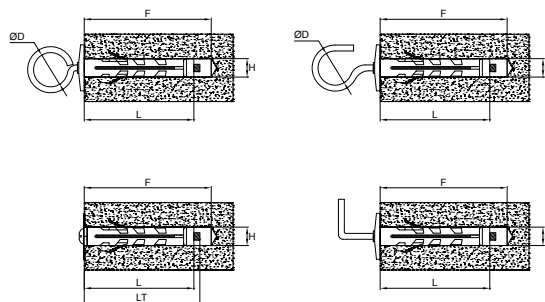

IPA-GR

Gancho recto

CÓDIGO	MXL	ESPEJOR MÁX. A FIJAR	Ø BROCA	PROFUNDIDAD MÍN. DE TALADRO	PROFUNDIDAD MÍN. DEL ANCLAJE	Ø ARANDELA	EXTRACCIÓN HORMIGÓN NO-FISURADO	EXTRACCIÓN LADRILLO MACIZO
IPAGR09	M4 x 40	-	9	45	40	20	8	8
IPAGR12	M5 x 45	-	12	50	45	25	12	12

IPA-GN

Gancho normal

CÓDIGO	MXL	ESPEJOR MÁX. A FIJAR	Ø BROCA	PROFUNDIDAD MÍN. DE TALADRO	PROFUNDIDAD MÍN. DEL ANCLAJE	Ø ARANDELA	EXTRACCIÓN HORMIGÓN NO-FISURADO	EXTRACCIÓN LADRILLO MACIZO
IPAGN09	M4 x 40	-	9	45	40	20	8	8
IPAGN12	M5 x 45	-	12	50	45	25	10	10

IPA-AR

Argolla

CÓDIGO	MXL	ESPEJOR MÁX. A FIJAR	Ø BROCA	PROFUNDIDAD MÍN. DE TALADRO	PROFUNDIDAD MÍN. DEL ANCLAJE	Ø ARANDELA	EXTRACCIÓN HORMIGÓN NO-FISURADO	EXTRACCIÓN LADRILLO MACIZO
IPAAR09	M4 x 40	-	9	45	40	20	8	8
IPAAR12	M5 x 45	-	12	50	45	25	10	10

IPA-TO

Tornillo

CÓDIGO	MXL	ESPEJOR MÁX. A FIJAR	Ø BROCA	PROFUNDIDAD MÍN. DE TALADRO	PROFUNDIDAD MÍN. DEL ANCLAJE	Ø ARANDELA	EXTRACCIÓN HORMIGÓN NO-FISURADO	EXTRACCIÓN LADRILLO MACIZO
IPATO09	M4 x 40	5	9	45	40	20	8	44
IPATO12	M5 x 45	5	12	50	45	25	12	56

TA-PL

Taco de plástico (polipropileno)

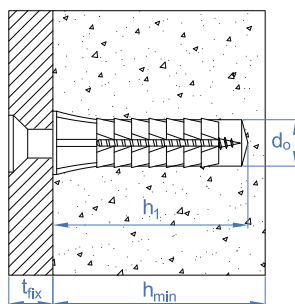

TA-PL

Taco de plástico, polipropileno

CÓDIGO	MXL	Ø BROCA	PROFUNDIDAD MÍN. DE TALADRO	MÍN. ESPESOR MATERIAL BASE	EXTRACCIÓN HORMIGÓN NO-FISURADO
TACOP05	5 x 21	5	30	35	5
TACOP06	6 x 22	6	30	35	5
TACOP07	7 x 23	7	30	35	6
TACOP08	8 x 27	8	35	40	9
TACOP09	9 x 30	9	35	40	9
TACOP10	10 x 35	10	40	45	13
TACOP11	10 x 43	10	50	55	15
TACOP12	12 x 45	12	50	55	17
TACOP14	14 x 48	14	55	60	28

BA-NO

Basculantes por gravedad para la fijación de elementos ligeros en falsos techos

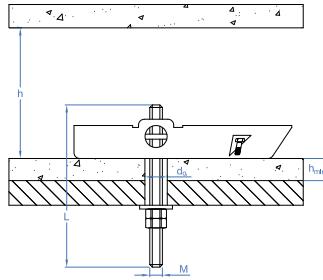

BA-ES

Espiga

CÓDIGO	MXL	MAX. ESPESOR CONJUNTO MATERIAL BASE Y ELEMENTO A FIJAR s	Ø BROCA	CAVIDAD MINIMA "H"	EXTRACCIÓN BOVEDILLA DE HORMIGÓN	EXTRACCIÓN CARTÓN YESO	EXTRACCIÓN ESCAYOLA
BAESM04	M4 x 100	74	14	70	10	5	5
BAESM05	M5 x 100	72	14	70	12	5	5
BAESM06	M6 x 100	68	16	75	13	6	6
BAESM08	M8 x 100	60	20	85	14	6	6

BA-GA

Gancho

CÓDIGO	MXL	MAX. ESPESOR CONJUNTO MATERIAL BASE Y ELEMENTO A FIJAR s	Ø BROCA	CAVIDAD MINIMA "H"	EXTRACCIÓN BOVEDILLA DE HORMIGÓN	EXTRACCIÓN CARTÓN YESO	EXTRACCIÓN ESCAYOLA
BAGAM04	M4 x 77	74	14	70	10	5	5
BAGAM05	M5 x 80	72	14	70	12	5	5
BAGAM06	M6 x 87	68	16	75	13	6	6
BAGAM08	M8 x 95	60	20	85	14	6	6

PA-LO

Palomilla con muelle

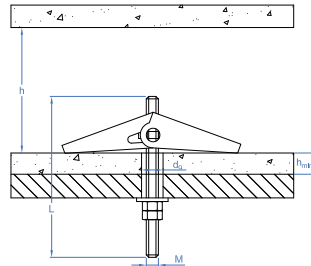

PA-ES

Espiga

CÓDIGO	MXL	MAX. ESPESOR CONJUNTO MATERIAL BASE Y ELEMENTO A FIJAR s	Ø BROCA	CAVIDAD MINIMA "H"	EXTRACCIÓN BOVEDILLA DE HORMIGÓN	EXTRACCIÓN CARTÓN YESO	EXTRACCIÓN ESCAYOLA
PAESM04	M4 x 100	75	12	26	10	5	5
PAESM05	M5 x 100	70	15	33	12	5	5
PAESM06	M6 x 100	66	18	37	13	6	6
PAESM08	M8 x 100	61	22	54	14	6	6

PA-GA

Gancho

CÓDIGO	MXL	MAX. ESPESOR CONJUNTO MATERIAL BASE Y ELEMENTO A FIJAR s	Ø BROCA	CAVIDAD MINIMA "H"	EXTRACCIÓN BOVEDILLA DE HORMIGÓN	EXTRACCIÓN CARTÓN YESO	EXTRACCIÓN ESCAYOLA
PAGAM04	M4 x 55	75	12	26	10	5	5
PAGAM05	M5 x 65	70	15	33	12	5	5
PAGAM06	M6 x 80	66	18	37	13	6	6
PAGAM08	M8 x 85	61	22	54	14	6	6

IN

Anclaje Indemoll para fijación en elementos huecos

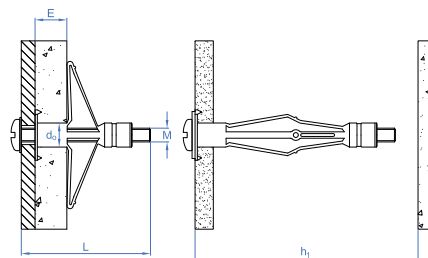

IN-CO

Con tornillo cabeza redonda

CÓDIGO	MXL	Ø BROCA	CAVIDAD MINIMA "H"	MÍN. ESPESOR MATERIAL BASE	ESPESOR MÁX. A FIJAR	EXTRACCIÓN CARTÓN YESO	EXTRACCIÓN ESCAYOLA
INCO421	M4 x 30	8	30	1-5	17 -hmin	20	20
INCO432	M4 x 41	8	41	3-10	22 -hmin	20	20

CÓDIGO	MXL	Ø BROCA	CAVIDAD MINIMA "H"	MÍN. ESPESOR MATERIAL BASE	ESPESOR MÁX. A FIJAR	EXTRACCIÓN CARTÓN YESO	EXTRACCIÓN ESCAYOLA
INCO438	M4 x 47	8	47	9-16	30 -hmin	20	20
INCO446	M4 x 53	8	53	15-22	33 -hmin	20	20
INCO459	M4 x 67	8	67	31-36	52 -hmin	20	20
INCO537	M5 x 46	10	46	5-14	26 -hmin	20	25
INCO552	M5 x 59	10	59	6-18	42 -hmin	20	30
INCO565	M5 x 72	10	72	16-33	55 -hmin	20	30
INCO580	M5 x 89	10	89	33-46	61 -hmin	20	30
INCO637	M6 x 46	12	46	5-13	25 -hmin	15	20
INCO652	M6 x 59	12	59	6-17	38 -hmin	20	25
INCO665	M6 x 72	12	72	14-32	49 -hmin	20	25
INCO680	M6 x 89	12	89	34-46	78 -hmin	20	25

IN-HE

Con tornillo cabeza hexagonal

CÓDIGO	MXL	Ø BROCA	CAVIDAD MINIMA "H"	MÍN. ESPESOR MATERIAL BASE	ESPESOR MÁX. A FIJAR	EXTRACCIÓN CARTÓN YESO	EXTRACCIÓN ESCAYOLA
INHE837	M8 x 45	14	45	5-13	25 -hmin	20	40
INHE855	M8 x 60	14	60	6-18	36 -hmin	20	40
INHE865	M8 x 73	14	73	17-33	47 -hmin	20	40

ANCLA

Taco de nylon para ladrillos huecos y placas de yeso

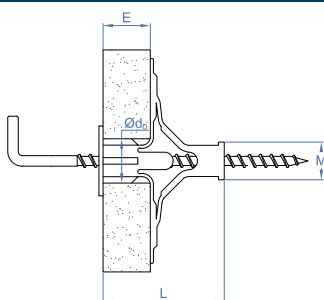

ANCLA

Taco de nylon para ladrillos huecos y placas de cartón yeso

CÓDIGO	MXL	Ø BROCA	MÍN. ESPESOR MATERIAL BASE	EXTRACCIÓN LADRILLO HUECO	EXTRACCIÓN CARTÓN YESO
ANCLA40	10 x 40	10	4-12	10	5
ANCLA47	10 x 47	10	15-19	10	5

TAPLA

Taco para placas de yeso laminado

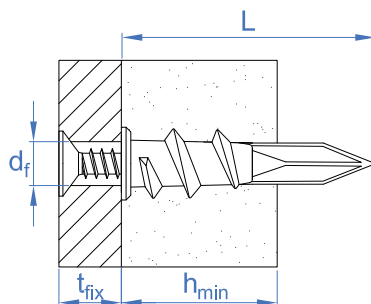

TAPLA NY

Taco de nylon

CÓDIGO	MXL	MÍN. ESPESOR MATERIAL BASE	VÁLIDO PARA	Nº HUELLA	EXTRACCIÓN CARTÓN YESO
TAPLANY	15 x 33	9-16	TPPO 4,5 x 40 / DIN-7981 4,2 x 38	PH3	8

TAPLA ME

Taco de Zamak con tornillo DIN 7981 4,2 x 32

CÓDIGO	MXL	MÍN. ESPESOR MATERIAL BASE	VÁLIDO PARA	Nº HUELLA	EXTRACCIÓN CARTÓN YESO
TAPLAME	13 x 32	9-16	DIN-7981 4,2 x 32	PH2/PH3	8

TAPLA ZK

Taco de Zamak

CÓDIGO	MXL	MÍN. ESPESOR MATERIAL BASE	VÁLIDO PARA	Nº HUELLA	EXTRACCIÓN CARTÓN YESO
TAPLAZK	13 x 37	9-16	TPPO 4,5 x 50 / DIN-7981 4,2 x 38	PZ3	8

AL

Alcayatas

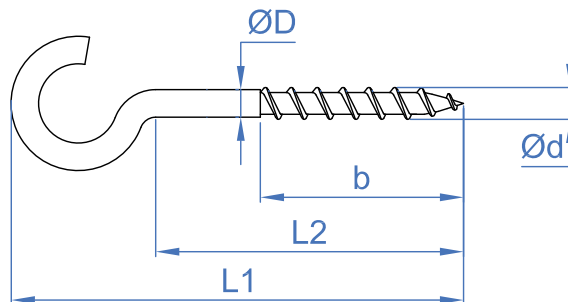

AL-HA

Hembrilla abierta

CODIGO	MXL	Ød	L1	B	L2	ØD
ALHA14025	2,6 x 18 x 7	2,6	18	7	10	2,1
ALHA16030	3,1 x 22 x 9	3,1	22	9	12	2,4
ALHA17040	3,5 x 26 x 10	3,5	26	10	14	2,7
ALHA18040	4,1 x 29 x 10	4,1	29	10	15	3,2
ALHA18050	4,1 x 34 x 12	4,1	34	12	20	3,2
ALHA19050	4,4 x 33 x 12	4,4	33	12	18	3,4
ALHA19060	4,4 x 39 x 15	4,4	39	15	22	3,4
ALHA19070	4,4 x 41 x 15	4,4	41	15	24	3,4
ALHA20050	5 x 35 x 12	5	35	12	19	3,9
ALHA20060	5 x 39 x 12	5	39	12	21	3,9
ALHA20070	5 x 44 x 14	5	44	14	26	3,9
ALHA20080	5 x 50 x 18	5	50	18	30	3,9
ALHA21070	5,6 x 43 x 14	5,6	43	14	23	4,4
ALHA21080	5,6 x 48 x 14	5,6	48	14	28	4,4
ALHA21090	5,6 x 56 x 14	5,6	56	14	32	4,4
ALHA21100	5,6 x 61 x 18	5,6	61	18	37	4,4
ALHA22110	6 x 69 x 24	6	69	24	43	4,7
ALHA22120	6 x 74 x 29	6	74	29	48	4,7
ALHA23130	6,3 x 82 x 35	6,3	82	35	55	5,2

AL-HA B

Hembrilla abierta roscada lacada blanca

CÓDIGO	MXL	Ød	L1	B	L2	ØD
ALHAB16030	3,1 x 22 x 9	3,1	22	9	12	2,4
ALHAB17040	3,5 x 26 x 10	3,5	26	10	14	2,7
ALHAB18050	4,1 x 34 x 12	4,1	34	12	20	3,2
ALHAB19060	4,4 x 39 x 15	4,4	39	15	22	3,4

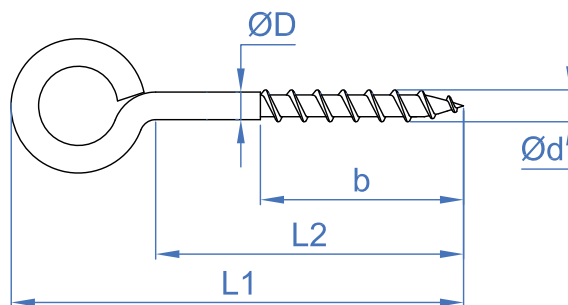

AL-HC

Hembrilla cerrada

CODIGO	MXL	Ød	L1	B	L2	ØD
ALHC14025	2,6 x 18 x 7	2,6	18	7	10	2,1
ALHC16030	3,1 x 22 x 9	3,1	22	9	12	2,4
ALHC17040	3,5 x 28 x 10	3,5	28	10	14	2,7
ALHC18040	4,1 x 30 x 10	4,1	30	10	15	3,2
ALHC18050	3,7 x 39 x 12	4,1	39	12	20	3,2
ALHC19050	4,4 x 35 x 12	4,4	35	12	18	3,4
ALHC19060	4,4 x 42 x 15	4,4	42	15	22	3,4
ALHC19070	4,4 x 44 x 15	4,4	44	15	24	3,4

CODIGO	MXL	Ød	L1	B	L2	ØD
ALHC20050	5 x 39 x 12	5	39	12	19	3,9
ALHC20060	5 x 41 x 12	5	41	12	21	3,9
ALHC20070	5 x 48 x 14	5	48	14	26	3,9
ALHC20080	5 x 54 x 18	5	54	18	30	3,9
ALHC21070	5,6 x 49 x 14	5,6	49	14	23	4,4
ALHC21080	5,6 x 54 x 14	5,6	54	14	28	4,4
ALHC21090	5,6 x 61 x 14	5,6	61	14	32	4,4
ALHC21100	5,6 x 66 x 18	5,6	66	18	37	4,4
ALHC22110	6 x 73 x 24	6	73	24	43	4,7
ALHC22120	6 x 81 x 29	6	81	29	48	4,7
ALHC23130	6,3 x 89 x 35	6,3	89	35	55	5,2

AL-HC B

Hembrilla cerrada roscada lacada blanca

CÓDIGO	MXL	Ød	L1	B	L2	ØD
ALHCB16030	3,1 x 22 x 9	3,1	22	9	12	2,4
ALHCB17040	3,5 x 28 x 10	3,5	28	10	14	2,7
ALHCB18050	3,7 x 39 x 12	3,7	39	12	20	3,2
ALHCB19060	4,4 x 42 x 15	4,4	42	15	22	3,4

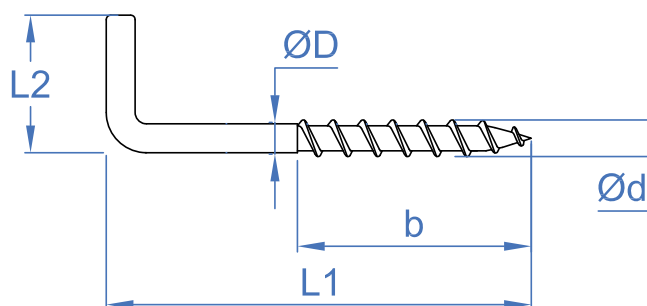

AL-RO

Alcayata roscada de hierro

CODIGO	MXL	Ød	L1	L2	B	ØD
ALRO14025	2,6 x 17 x 10	2,6	17	10	10	2
ALRO16030	3,1 x 20 x 10	3,1	20	10	12	2,4
ALRO17040	3,5 x 29 x 13	3,5	29	13	17	2,7
ALRO18040	3,7 x 28 x 14	3,7	28	14	17	2,9
ALRO18050	3,7 x 37 x 15	3,7	37	15	22	2,9
ALRO19050	4,4 x 37 x 15	4,4	37	15	22	3,4
ALRO19060	4,4 x 46 x 17	4,4	46	17	28	3,4
ALRO19070	4,4 x 55 x 18	4,4	55	18	33	3,4
ALRO20060	5 x 44 x 20	5	44	20	26	3,9
ALRO20070	5 x 53 x 20	5	53	20	32	3,9
ALRO20080	5 x 63 x 21	5	63	21	38	3,9
ALRO21080	5,6 x 60 x 22	5,6	60	22	36	4,4
ALRO21090	5,6 x 70 x 22	5,6	70	22	42	4,4
ALRO22100	6 x 79 x 23	6	79	23	47	4,7
ALRO22110	6 x 86 x 23	6	86	23	52	4,7
ALRO22120	6 x 97 x 25	6	97	25	58	4,7
ALRO23130	7,8 x 105 x 25	7,8	105	25	63	5,8

AL-RO B

Alcayata roscada lacada blanca

CÓDIGO	MXL	Ød	L1	L2	B	ØD
ALROB16030	3,1 x 20 x 10	3,1	20	10	10	2,4
ALROB17040	3,5 x 29 x 13	3,5	29	13	13	2,7
ALROB18050	3,7 x 37 x 15	3,7	37	15	18	2,9
ALROB19060	4,4 x 46 x 17	4,4	46	17	24	3,4

Parámetros punta-broca

			Ø 3.5	Ø 3.9	Ø 4.2	Ø 4.8	Ø 5.5	Ø 6.3
Fuerza máxima instalación		N	150	200	250	250	350	350
Velocidad taladrado	Acero	rpm	1.800 - 2500				1000 - 1800	
	Acero inox	rpm	1.000 - 1500				600 - 1000	
Par máximo		Nm	2.8	3.8	4.7	6.9	10.4	16.9



Taladro previo rosca-chapa

Medida	Espesor de chapa	Ø Broca núcleo		Medida	Espesor de chapa	Ø Broca núcleo	
		Aluminio	Acero-latón			Aluminio	Acero-latón
2,9 Nº4	0,4 - 0,6	2,20	2,25	4,8 Nº10	0,4 - 0,6	-	-
	0,6 - 1,0	2,20	2,40		0,6 - 1,0	3,70	3,80
	1,0 - 1,5	2,25	2,40		1,0 - 1,5	3,70	3,80
	1,5 - 2,5	2,40	2,50		1,5 - 2,5	3,80	3,90
	2,5 - 4,0	-	-		2,5 - 4,0	3,80	4,00
3,5 Nº6	0,4 - 0,6	2,70	2,70	5,5 Nº12	0,4 - 0,6	-	-
	0,6 - 1,0	2,70	2,80		0,6 - 1,0	4,30	4,40
	1,0 - 1,5	2,80	2,80		1,0 - 1,5	4,30	4,40
	1,5 - 2,5	2,80	2,90		1,5 - 2,5	4,40	4,50
	2,5 - 4,0	-	3,00		2,5 - 4,0	4,40	4,60
3,9 Nº7	0,4 - 0,6	-	-	6,3 Nº14	0,4 - 0,6	-	-
	0,6 - 1,0	3,00	3,10		0,6 - 1,0	5,00	5,10
	1,0 - 1,5	3,00	3,10		1,0 - 1,5	5,00	5,10
	1,5 - 2,5	3,10	3,20		1,5 - 2,5	5,10	5,20
	2,5 - 4,0	3,10	3,30		2,5 - 4,0	5,10	5,30
4,2 Nº8	0,4 - 0,6	-	-				
	0,6 - 1,0	3,20	3,30				
	1,0 - 1,5	3,20	3,30				
	1,5 - 2,5	3,30	3,40				
	2,5 - 4,0	3,30	3,50				



Tabla de selección de tornillos punta broca

TORNILLO	Ø ROSCA	ESPESOR A TALADRAR EN ACERO [mm]																		
AUTO	5,5	4,0																	12,0	
ABE ABR ABP RS	6,3	2,5													6,0					
	5,5	1,75										5,25								
	4,8	1,75										4,4								
	4,2	1,75										3,0								
	3,9	0,7		2,4																
	3,5	0,7		2,25																
ABA / ATA	6,3	2,5													6,0					
	5,5	1,75										5,0								
	4,8	1,75										4,0								
TAE	4,2	0,75		2,5																
BCP	4,2	0,7		2,0																
ARE	6,3	1,0		1,5																
	5,5	1,0		1,5																
	4,8	0,3		1,0																
PS	5,5	1,5										6,0								
PSL	5,5	6,0																	12,0	
0,00 0,25 0,50 0,75 1,00 1,25 1,50 1,75 2,00 2,25 2,50 2,75 3,00 3,25 3,50 3,75 4,00 4,25 4,50 4,75 5,00 5,25 5,50 5,75 6,00 6,5 7,0 7,5 8,0 8,5 9,0 9,5 10,0 10,5 11,0 11,5 12,0																				

TORNILLO	Ø ROSCA	ESPESOR A TALADRAR EN ALUMINIO [mm]																		
BIE	4,8	1,75										4,4								
	5,5	1,75										5,25								
	6,3	2,5										6,0								
BAUTO	5,5	4,0																	12,0	
0,00 0,25 0,50 0,75 1,00 1,25 1,50 1,75 2,00 2,25 2,50 2,75 3,00 3,25 3,50 3,75 4,00 4,25 4,50 4,75 5,00 5,25 5,50 5,75 6,00 6,5 7,0 7,5 8,0 8,5 9,0 9,5 10,0 10,5 11,0 11,5 12,0																				

Espesor máximo a fijar

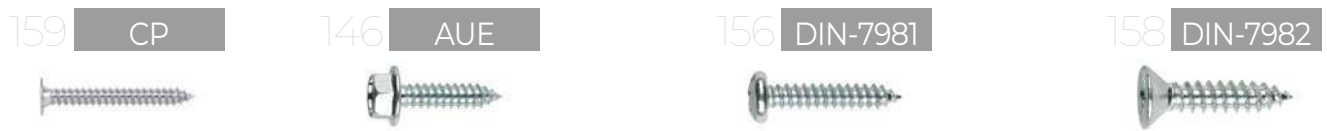
LONGITUD	ST 3,5	ST 3,9	ST 4,2	ST 4,8	ST 5,5	ST 6,3
9,5	2,85					
11	4,2					
13	6,2	5,8	4,3	3,7		
16	9,2	8,8	7,3	5,5		
19	12,1	11,7	10,3	8,7	8,7	7
22	15,1	14,7	13,3	11,7	11,7	10
25	18,1	17,7	16,3	14,7	14,7	13
32	25,1	24,5	23	21,5	21,5	20
38		30,5	29	27,5	27,5	26
45			36	34,5	34,5	33
50			41	39,5	39,5	38
60				49,5	49,5	48
63				52,5	52,5	51
73				62,5	62,5	61
75				64,5	64,5	63
80				69,5		68
90				79,5		78
100				89,5		88
110						98
120						108
130						118
140						128

* No válido para tornillo AUTO

AB-IA / AB-RA Abrazadera reforzada M8 abierta

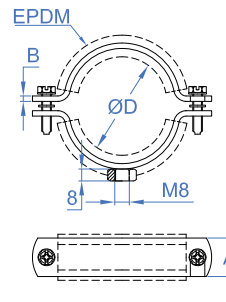
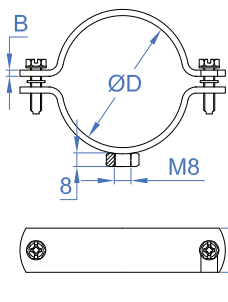

AB-RA / AB-IA Abrazadera reforzada M8 Abierta

CÓDIGO	ØD(MM)	ØD(")	A X B	CARGA MÁXIMA
ABIA015 / ABRA015	12 - 16	1/4"	20 x 1,5	80
ABIA018 / ABRA018	15 - 19	3/8"	20 x 1,5	80
ABIA022 / ABRA022	20 - 25	1/2"	20 x 1,5	80
ABIA028 / ABRA028	26 - 30	3/4"	20 x 1,5	80
ABIA035 / ABRA035	32 - 36	1"	20 x 1,5	80
ABIA042 / ABRA042	38 - 43	1 1/4"	20 x 1,5	80
ABIA048 / ABRA048	47 - 51	1 1/2"	20 x 1,5	80
ABIA054 / ABRA054	53 - 58	-	20 x 1,5	80
ABIA060 / ABRA060	60 - 64	2"	20 x 1,5	80
ABIA075 / ABRA075	75 - 80	2 1/2"	20 x 1,5	80
ABIA090 / ABRA090	87 - 92	3"	20 x 1,5	80
ABIA100 / ABRA100	99 - 105	3 1/2"	20 x 1,5	80
ABIA110 / ABRA110	107 - 112	-	20 x 1,5	80
ABIA115 / ABRA115	113 - 118	4"	20 x 1,5	80
ABIA125 / ABRA125	125 - 130	4 1/2"	20 x 1,5	80

AB-IR Abrazadera isofónica M8 instalación rápida

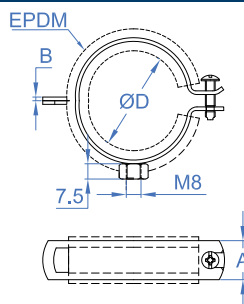

AB-IR Abrazadera isofónica M8 instalación rápida

CÓDIGO	ØD(MM)	ØD(")	A X B	CARGA MÁXIMA
ABIR015	14 - 15	1/4"	19 x 1,25	60
ABIR018	16 - 19	3/8"	19 x 1,25	60
ABIR022	21 - 23	1/2"	19 x 1,25	60
ABIR028	26 - 28	3/4"	19 x 1,25	60
ABIR035	32 - 35	1"	19 x 1,25	60
ABIR040	40 - 43	1 1/4"	19 x 1,25	60
ABIR048	48 - 51	1 1/2"	19 x 1,25	60
ABIR054	52 - 56	-	19 x 1,25	60
ABIR060	57 - 60	2"	19 x 1,25	60

AB-RI / AB-RE Abrazadera isofónica reforzada M8 + M10

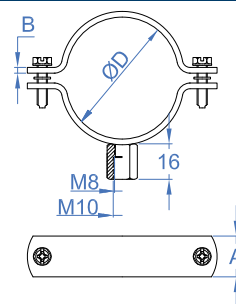
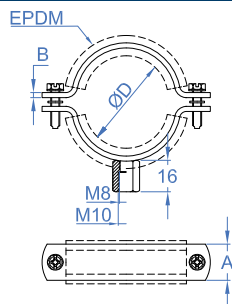

AB-RI / AB-RE Cincada

CÓDIGO	ØD(MM)	ØD(")	A X B	CARGA MÁXIMA
ABRI018 / ABRE018	15 - 19	3/8"	19 x 1,8	150
ABRI022 / ABRE022	20 - 25	1/2"	19 x 1,8	150
ABRI028 / ABRE028	26 - 30	3/4"	19 x 1,8	150
ABRI035 / ABRE035	32 - 36	1"	19 x 1,8	150
ABRI040 / ABRE040	38 - 43	1 1/4"	19 x 1,8	150
ABRI048 / ABRE048	47 - 51	1 1/2"	19 x 1,8	150
ABRI054 / ABRE054	53 - 56	-	19 x 1,8	150
ABRI060 / ABRE060	60 - 64	2"	19 x 1,8	150
ABRI070 / ABRE070	68 - 72	-	19 x 1,8	150
ABRI075 / ABRE075	75 - 80	2 1/2"	19 x 1,8	150
ABRI083 / ABRE083	81 - 86	-	19 x 1,8	150
ABRI090 / ABRE090	87 - 92	3"	19 x 1,8	150
ABRI100 / ABRE100	99 - 105	3 1/2"	19 x 1,8	150
ABRI110 / ABRE110	107 - 112	-	19 x 2,3	200
ABRI115 / ABRE115	113 - 118	4"	19 x 2,3	200
ABRI125 / ABRE125	125 - 130	4 1/2"	19 x 2,3	200
ABRI133 / ABRE133	132 - 137	-	19 x 2,3	200
ABRI140 / ABRE140	138 - 142	5"	19 x 2,3	200
ABRI150 / ABRE150	148 - 152	-	19 x 2,3	200
ABRI160 / ABRE160	159 - 166	6"	19 x 2,3	200
ABRI180 / ABRE180	179 - 184	-	19 x 2,3	200
ABRI200 / ABRE200	199 - 212	-	19 x 2,3	200
ABRI220 / ABRE220	215 - 226	8"	19 x 2,3	200
ABRI250 / ABRE250	245 - 254	-	19 x 2,3	200
ABRI280 / ABRE280	278 - 284	-	19 x 2,3	200
ABRI300 / ABRE300	299 - 304	-	19 x 2,3	200
ABRI315 / ABRE315	314 - 319	-	19 x 2,3	200
ABRI355 / ABRE355	354 - 359	-	19 x 2,3	200

AB-RI V / AB-RE V Cincada. Ventilación

CÓDIGO	ØD(MM)	ØD(")	A X B	CARGA MÁXIMA
ABRI250 / ABRE250	245 - 254	-	19 x 2,3	200
ABRI280 / ABRE280	278 - 284	-	19 x 2,3	200
ABRI300 / ABRE300	299 - 304	-	19 x 2,3	200
ABRI315 / ABRE315	314 - 319	-	19 x 2,3	200
ABRI355 / ABRE355	354 - 359	-	19 x 2,3	200
ABRI400 / ABRE400	399 - 404	-	19 x 2,3	200
ABRI450 / ABRE450	449 - 454	-	19 x 2,3	200
ABRI500 / ABRE500	499 - 504	-	19 x 2,3	200
ABRI560 / ABRE560	555 - 561	-	19 x 2,3	200
ABRI600 / ABRE600	599 - 604	-	19 x 2,3	200
ABRI630 / ABRE630	625 - 631	-	19 x 2,3	200
ABRI710 / ABRE710	705 - 711	-	19 x 2,3	200
ABRI800 / ABRE800	799 - 804	-	19 x 2,3	200
ABRI900 / ABRE900	899 - 904	-	19 x 2,3	200
ABRI910 / ABRE910	999 - 1.004	-	19 x 2,3	200
ABRI911 / ABRE911	1.115 - 1.121	-	19 x 2,3	200
ABRI912 / ABRE912	1.245 - 1.251	-	19 x 2,3	200

AB-RI A2 / AB-RI A4 Abrazadera isofónica reforzada M8 + M10

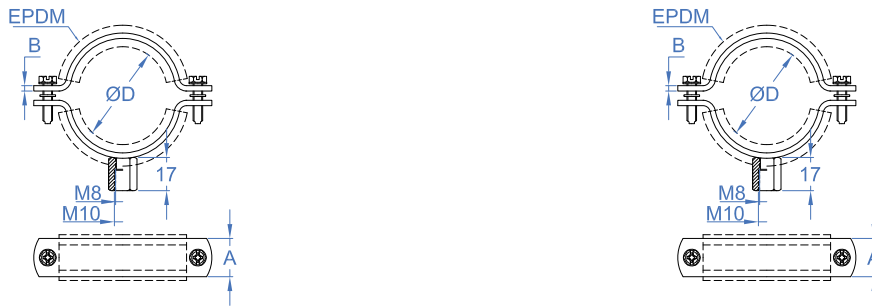

AB-RI A2 / AB-RI A4 Inoxidable A2

CÓDIGO	ØD(MM)	ØD(")	A X B	CARGA MÁXIMA
ABRIA2018 / ABRIA4018	15 - 18	3/8"	19 x 1,8	150
ABRIA2022 / ABRIA4022	20 - 24	1/2"	19 x 1,8	150
ABRIA2028 / ABRIA4028	26 - 30	3/4"	19 x 1,8	150
ABRIA2035 / ABRIA4035	32 - 36	1"	19 x 1,8	150
ABRIA2040 / ABRIA4040	36 - 42	1 1/4"	19 x 1,8	150
ABRIA2048 / ABRIA4048	47 - 50	1 1/2"	19 x 1,8	150
ABRIA2054 / ABRIA4054	51 - 55	-	19 x 1,8	150
ABRIA2060 / ABRIA4060	60 - 64	2"	19 x 1,8	150
ABRIA2075 / ABRIA4075	75 - 80	2 1/2"	19 x 1,8	150
ABRIA2090 / ABRIA4090	87 - 92	3"	19 x 1,8	150
ABRIA2110 / ABRIA4110	106 - 112	-	19 x 1,8	150
ABRIA2115 / ABRIA4115	114 - 119	4"	19 x 1,8	150
ABRIA2125 / ABRIA4125	124 - 131	4 1/2"	19 x 1,8	150
ABRIA2140 / ABRIA4140	133 - 140	5"	19 x 1,8	150
ABRIA2160 / ABRIA4160	159 - 163	6"	19 x 1,8	150

AB-RE A2 / AB-RE A4 Abrazadera reforzada M8 + M10



AB-RE A2 / AB-RE A4 Inoxidable A2

CÓDIGO	ØD(MM)	ØD(")	A X B	CARGA MÁXIMA
ABREA2018 / ABREA4018	15 - 18	3/8"	19 x 1,8	150
ABREA2022 / ABREA4022	20 - 24	1/2"	19 x 1,8	150
ABREA2028 / ABREA4028	26 - 30	3/4"	19 x 1,8	150
ABREA2035 / ABREA4035	32 - 36	1"	19 x 1,8	150
ABREA2040 / ABREA4040	36 - 42	1 1/4"	19 x 1,8	150
ABREA2048 / ABREA4048	47 - 50	1 1/2"	19 x 1,8	150
ABREA2054 / ABREA4054	51 - 55	-	19 x 1,8	150
ABREA2060 / ABREA4060	60 - 64	2"	19 x 1,8	150
ABREA2075 / ABREA4075	75 - 80	2 1/2"	19 x 1,8	150
ABREA2090 / ABREA4090	87 - 92	3"	19 x 1,8	150
ABREA2110 / ABREA4110	106 - 112	-	19 x 1,8	150
ABREA2115 / ABREA4115	114 - 119	4"	19 x 1,8	150
ABREA2125 / ABREA4125	124 - 131	4 1/2"	19 x 1,8	150
ABREA2140 / ABREA4140	133 - 140	5"	19 x 1,8	150
ABREA2160 / ABREA4160	159 - 163	6"	19 x 1,8	150
ABREA2200 / ABREA4200	199 - 212	-	19 x 1,8	150

AB-GA

Abrazadera gásmica M8 + M10 amarilla

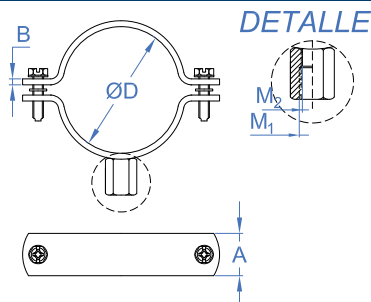

AB-GA

Abrazadera gásmica M8 + M10 amarilla

CÓDIGO	ØD(MM)	ØD(°)	A X B	MÉTRICA	CARGA MÁXIMA
ABGA018	15 - 18	3/8"	20 x 2	M8	200
ABGA022	20 - 24	1/2"	20 x 2	M8	200
ABGA028	26 - 30	3/4"	20 x 2	M8	200
ABGA035	32 - 36	1"	20 x 2	M8	200
ABGA040	38 - 42	1 1/4"	20 x 2	M8	200
ABGA048	47 - 50	1 1/2"	20 x 2	M8	200
ABGA054	52 - 56	-	20 x 2	M8	200
ABGA060	60 - 64	2"	20 x 2	M8/M10	200
ABGA075	75 - 80	2 1/2"	20 x 2	M8/M10	200
ABGA090	85 - 90	3"	20 x 2	M8/M10	200
ABGA100	99 - 105	3 1/2"	20 x 2	M8/M10	200
ABGA110	107 - 112	-	20 x 2	M8/M10	200
ABGA115	113 - 118	4"	20 x 2	M8/M10	200
ABGA140	138 - 142	5"	20 x 2	M8/M10	200
ABGA160	159 - 166	6"	20 x 2	M8/M10	200

AB-M8

Abrazadera desagüe M8

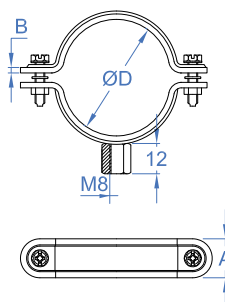

AB-M8

Abrazadera desagüe M8

CÓDIGO	ØD(MM)	ØD(°)	A X B	CARGA MÁXIMA
ABM8050	49 - 54	-	28 x 0,8	100
ABM8063	60 - 65	-	28 x 0,8	100
ABM8075	75 - 80	-	28 x 0,8	100
ABM8090	88 - 92	-	28 x 0,8	100
ABM8110	108 - 113	-	28 x 0,8	100
ABM8125	124 - 130	-	28 x 0,8	100
ABM8160	159 - 165	-	28 x 0,8	100
ABM8200	199 - 203	-	28 x 0,8	100
ABM8250	249 - 254	-	28 x 0,8	100
ABM8315	314 - 319	-	28 x 0,8	100

AB-DE Z / AB-DE G Abrazadera desagüe de empotrar

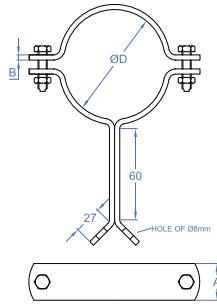

AB-DE Z / AB-DE G Zincada / Galvanizada

CÓDIGO	ØD(MM)	ØD(°)	A X B	CARGA MÁXIMA
ABDE075	75 - 80	2 1/2"	20 x 2,5	200
ABDE090	87 - 92	3"	20 x 2,5	200
ABDE110	107 - 112	-	20 x 2,5	200
ABDE125	125 - 130	4 1/2"	20 x 2,5	200
ABDE160	159 - 166	6"	20 x 2,5	200
ABDE200	199 - 212	-	20 x 2,5	200
ABDE250	245 - 254	-	20 x 2,5	200
ABDE315	314 - 319	-	20 x 2,5	200

AB-DP Z / AB-DP G Abrazadera desagüe con pie

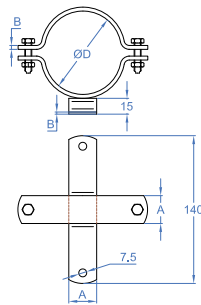

AB-DP Z / AB-DP G Zincada / Galvanizada

CÓDIGO	ØD(MM)	ØD(°)	A X B	CARGA MÁXIMA
ABDP075	75 - 80	2 1/2"	20 x 2	200
ABDP090	87 - 92	3"	20 x 2	200
ABDP110	107 - 112	-	20 x 2	200
ABDP125	125 - 130	4 1/2"	20 x 2	200
ABDP160	159 - 166	6"	20 x 2	200
ABDP200	199 - 212	-	20 x 2	200
ABDP250	245 - 254	-	20 x 2	200

AB-ZI

Abarcón

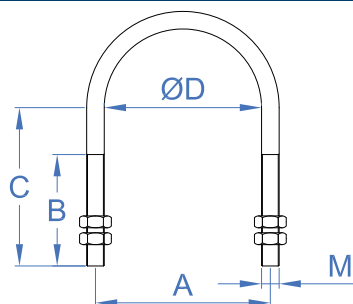

AB-ZI

Cincada

CÓDIGO	ØD(")	MÉTRICA	AXBXC	CARGA MÁXIMA
AZIM060250	1/4"	M6	20 / 14 / 20	250
AZIM060375	3/8"	M6	23,5 / 15 / 23	250
AZIM060500	1/2"	M6	27,5 / 17 / 25	250
AZIM060750	3/4"	M6	33 / 19 / 31	250
AZIM061000	1"	M6	39,5 / 24 / 39	250
AZIM061250	1 1/4"	M6	48,5 / 24 / 44	250
AZIM081500	1 1/2"	M8	56,5 / 26 / 48	350
AZIM082000	2"	M8	68,5 / 26 / 53	350
AZIM082250	2 1/4"	M8	83 / 35 / 63	350
AZIM082500	2 1/2"	M8	83 / 35 / 71	350
AZIM083000	3"	M8	99 / 35 / 76	350
AZIM083500	3 1/2"	M8	112 / 35 / 82	350
AZIM084000	4"	M8	125 / 35 / 87	350
AZIM084500	4 1/2"	M8	140 / 40 / 100	350
AZIM085000	5"	M8	152 / 40 / 105	350
AZIM086000	6"	M8	179 / 40 / 118	350
AZIM103000	3"	M10	100 / 45 / 66	350
AZIM103500	3 1/2"	M10	110 / 50 / 94	350
AZIM104000	4"	M10	125 / 55 / 97,5	350
AZIM105000	5"	M10	150 / 55 / 108	350
AZIM106000	6"	M10	170 / 55 / 125	350
AZIM108000	8"	M10	230 / 55 / 148	350

AB-SA

Soporte de abarcón

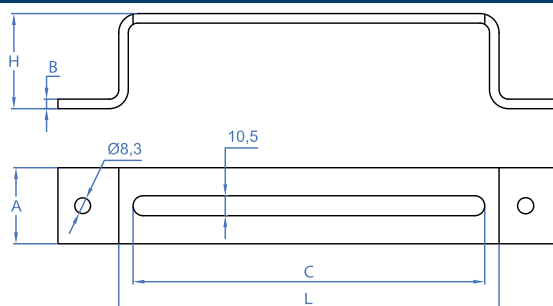

AB-SA

Soporte de abarcón

CÓDIGO	L	H	AXB	C
ABSA050100	100	50	40 x 5	85
ABSA050125	125	50	40 x 5	110
ABSA050200	200	50	40 x 5	185
ABSA050300	300	50	40 x 5	285
ABSA050400	400	50	40 x 5	385
ABSA050500	500	50	40 x 5	485
ABSA050600	600	50	40 x 5	585
ABSA100100	100	100	40 x 5	85
ABSA100125	125	100	40 x 5	110
ABSA100200	200	100	40 x 5	185
ABSA100300	300	100	40 x 5	285
ABSA100400	400	100	40 x 5	385
ABSA100500	500	100	40 x 6	485

AB-GP

Abrazadera de gran presión

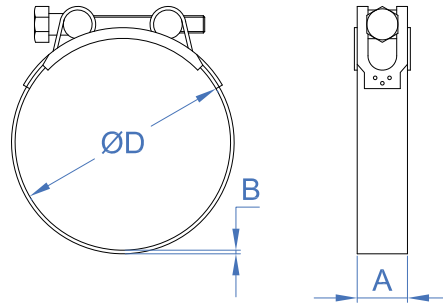

AB-GP

Abrazadera de gran presión

CÓDIGO	M X L	ØD(MM)	A X B
AGP023025	M5 x 35	23 - 25	18 X 0,6
AGP026028	M5 x 35	26 - 28	18 X 0,6
AGP029031	M5 x 35	29 - 31	18 X 0,6
AGP032035	M6 x 50	32 - 35	20 X 1
AGP036039	M6 x 50	36 - 39	20 X 1
AGP040043	M6 x 50	40 - 43	20 X 1
AGP044047	M6 x 50	44 - 47	20 X 1
AGP048051	M6 x 50	48 - 51	20 X 1
AGP052055	M6 x 50	52 - 55	20 X 1
AGP056059	M6 x 55	56 - 59	20 X 1
AGP060063	M6 x 55	60 - 63	20 X 1
AGP064067	M8 x 70	64 - 67	25 X 1,5
AGP068073	M8 x 70	68 - 73	25 X 1,5
AGP074079	M8 x 70	74 - 79	25 X 1,5
AGP080085	M8 x 70	80 - 85	25 X 1,5
AGP086091	M8 x 70	86 - 91	25 X 1,5
AGP092097	M8 x 70	92 - 97	25 X 1,5
AGP098103	M8 x 70	98 - 103	25 X 1,5
AGP104112	M8 x 80	104 - 112	25 X 1,5
AGP113121	M8 x 80	113 - 121	25 X 1,5
AGP122130	M8 x 80	122 - 130	25 X 1,5
AGP131139	M8 x 80	131 - 139	25 X 1,5
AGP140148	M8 x 80	140 - 148	25 X 1,5
AGP149161	M8 x 80	149 - 161	25 X 1,8
AGP162174	M8 x 80	162 - 174	25 X 1,8
AGP175187	M10 x 110	175-187	25 X 1,8
AGP188200	M10 x 110	188-200	25 X 1,8
AGP201213	M10 x 110	201-213	25 X 1,8
AGP214226	M10 x 110	214-226	25 X 1,8

AB-M6

Abrazadera M6

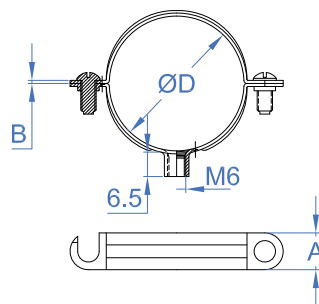

AB-M6 Z / AB-M6 Cincada

CÓDIGO	ØD(MM)	ØD(")	A X B	CARGA MÁXIMA
ABM6008 / ABMZ6008	8	-	10 x 1	70
ABM6010 / ABMZ6010	10	1/8"	10 x 1	70
ABM6012 / ABMZ6012	12	-	10 x 1	70
ABM6014 / ABMZ6014	14	1/4"	10 x 1	70
ABM6015 / ABMZ6015	15	-	10 x 1	70
ABM6016 / ABMZ6016	16	-	10 x 1	70

CÓDIGO	ØD(MM)	ØD(")	A X B	CARGA MÁXIMA
ABM6018 / ABMZ6018	18	3/8"	10 x 1	70
ABM6020 / ABMZ6020	20	-	10 x 1	70
ABM6022 / ABMZ6022	22	1/2"	10 x 1	70
ABM6025 / ABMZ6025	25	-	10 x 1	70
ABM6026 / ABMZ6026	26	3/4"	10 x 1	70
ABM6028 / ABMZ6028	28	-	10 x 1	70
ABM6032 / ABMZ6032	32	1"	10 x 1	70
ABM6035 / ABMZ6035	35	-	12 x 1,2	70
ABM6037 / ABMZ6037	37	-	12 x 1,2	100
ABM6040 / ABMZ6040	40	-	12 x 1,2	100
ABM6042 / ABMZ6042	42	1 1/4"	12 x 1,2	100
ABM6047 / ABMZ6047	47	1 1/2"	12 x 1,2	100
ABM6050 / ABMZ6050	50	-	12 x 1,2	100
ABM6054 / ABMZ6054	54	-	12 x 1,2	100
ABM6060 / ABMZ6060	60	2"	12 x 1,2	100
ABM6063 / ABMZ6063	63	-	12 x 1,2	100

AB-D6

Abrazadera doble M6

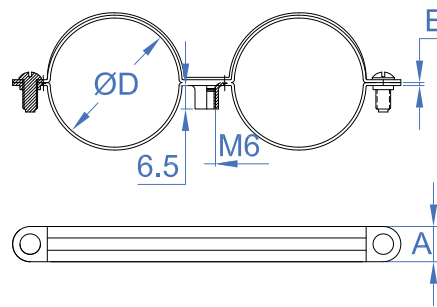

AB-D6 Z / AB-D6 Cincada

CÓDIGO	ØD(MM)	ØD(")	A X B	CARGA MÁXIMA
ABD6012 / ABDZ6012	12	1/8"	12 x 1	100
ABD6015 / ABDZ6015	15	1/4"	12 x 1,2	100
ABD6018 / ABDZ6018	18	3/8"	12 x 1,2	100
ABD6022 / ABDZ6022	22	1/2"	12 x 1,2	100
ABD6028 / ABDZ6028	28	3/4"	12 x 1,2	100

AB-M6 A2

Abrazadera M6

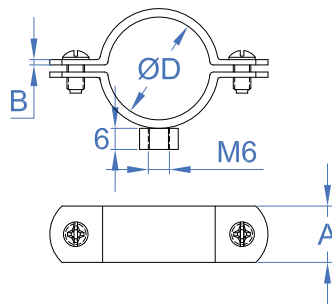

AB-M6 A2

Inoxidable A2

CÓDIGO	ØD(MM)	ØD(")	A X B	CARGA MÁXIMA
ABM6A2012	12	1/4"	16 x 1,5	70
ABM6A2015	14 - 15	-	16 x 1,5	70
ABM6A2018	16 - 18	3/8"	16 x 1,5	70
ABM6A2020	19 - 21	1/2"	16 x 1,5	70
ABM6A2022	22 - 24	-	16 x 1,5	70
ABM6A2028	25 - 30	3/4"	16 x 1,5	70

AB-6I

Abrazadera isofónica M6

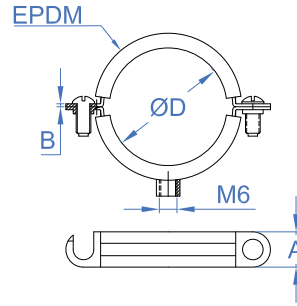

AB-6I

Abrazadera isofónica M6

CÓDIGO	ØD(MM)	ØD(ʹ)	A X B	CARGA MÁXIMA
AB6I012	12	1/8"	15 x 1,2	70
AB6I015	15	1/4"	15 x 1,2	70
AB6I016	16	-	15 x 1,2	70
AB6I018	18	3/8"	15 x 1,2	70
AB6I022	22	1/2"	15 x 1,2	70
AB6I026	26	-	15 x 1,2	70
AB6I028	28	3/4"	15 x 1,2	70
AB6I032	32	-	15 x 1,2	70
AB6I035	35	1"	15 x 1,2	70
AB6I042	42	1 1/4"	15 x 1,2	100
AB6I048	48	1 1/2"	15 x 1,2	100
AB6I054	54	-	15 x 1,2	100
AB6I060	60	2"	15 x 1,2	100

AB-DI

Abrazadera doble isofónica M6

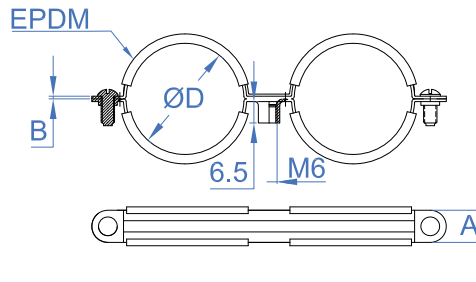

AB-DI

Abrazadera M6. Bicromatada

CÓDIGO	ØD(MM)	ØD(ʹ)	A X B	CARGA MÁXIMA
ABDI0012	12	1/8"	15 x 1	100
ABDI0015	15	1/4"	15 x 1,2	100
ABDI0018	18	3/8"	15 x 1,2	100
ABDI0022	22	1/2"	15 x 1,2	100
ABDI0028	28	3/4"	15 x 1,2	100

AB-M7

Abrazadera M6

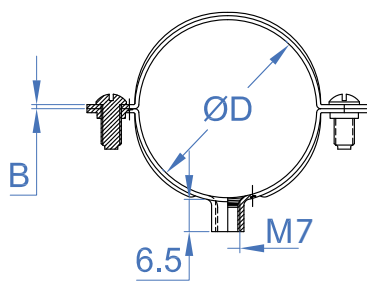

AB-M7

Cincada

CÓDIGO	ØD(MM)	ØD(")	A X B	CARGA MÁXIMA
ABMZ7008	8	-	11 X 1	-
ABMZ7010	10	1/8"	11 X 1	-
ABMZ7012	12	-	11 X 1	-
ABMZ7014	14	1/4"	11 X 1	-
ABMZ7016	16	-	11 X 1	-
ABMZ7018	18	3/8"	11 X 1	-
ABMZ7020	20	-	11 X 1	-
ABMZ7022	22	1/2"	11 X 1	-
ABMZ7024	24	-	11 X 1	-
ABMZ7025	25	-	11 X 1	-
ABMZ7026	26	3/4"	11 X 1	-
ABMZ7028	28	-	11 X 1	-
ABMZ7032	32	1"	11 X 1	-
ABMZ7034	34	-	11 X 1	-
ABMZ7036	36	-	11 X 1	-
ABMZ7038	38	-	11 X 1	-
ABMZ7040	40	-	11 X 1	-
ABMZ7050	50	-	11 X 1	-
ABMZ7063	63	-	12 X 1,2	-

AB-D7

Abrazadera doble M6

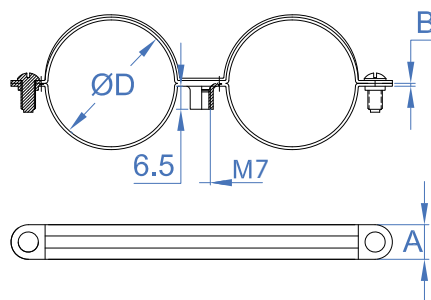

AB-D7

Cincada

CÓDIGO	ØD(MM)	ØD(")	A X B	CARGA MÁXIMA
ABDZ70810	8-10	-	11 X 1	-
ABDZ71012	10-12	1/8"	11 X 1	-
ABDZ71214	12-14	-	11 X 1	-
ABDZ71416	14-16	-	11 X 1	-
ABDZ71618	16-18	3/8"	11 X 1	-
ABDZ71820	18-20	-	11 X 1	-
ABDZ72022	20-22	1/2"	11 X 1	-
ABDZ72224	22-24	-	11 X 1	-
ABDZ72628	26-28	3/4"	11 X 1	-

AB-7I

Abrazadera isofónica M6

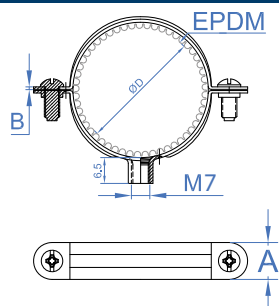

AB-7I

Abrazadera isofónica M6

CÓDIGO	ØD(MM)	ØD('')	A X B	CARGA MÁXIMA
AB7IZ010	10	-	11 X 1	-
AB7IZ012	12	-	11 X 1	-
AB7IZ014	14	-	11 X 1	-
AB7IZ016	16	-	11 X 1	-
AB7IZ018	18	-	11 X 1	-
AB7IZ020	20	-	11 X 1	-
AB7IZ022	22	-	11 X 1	-
AB7IZ024	24	-	11 X 1	-
AB7IZ026	26	-	11 X 1	-
AB7IZ028	28	-	11 X 1	-
AB7IZ032	32	-	11 X 1	-
AB7IZ034	34	-	11 X 1	-
AB7IZ036	36	-	12 X 1	-
AB7IZ038	38	-	12 X 1	-
AB7IZ040	40	-	12 X 1	-
AB7IZ050	50	-	12 X 1,2	-

AB-7ID

Abrazadera doble isofónica M6

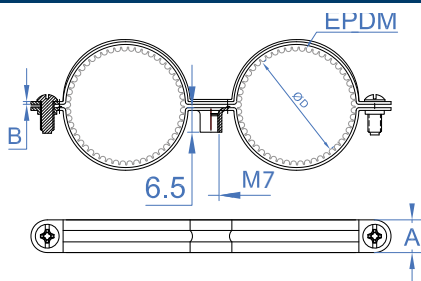

AB-7ID

Abrazadera M6. Bicromatada

CÓDIGO	ØD(MM)	ØD('')	A X B	CARGA MÁXIMA
AB7IDZ0810	08-10	1/8"	11 X 1	-
AB7IDZ1012	10-12	1/8"	11 X 1	-
AB7IDZ1214	12-14	1/4"	11 X 1	-
AB7IDZ1416	14-16	1/4"	11 X 1	-
AB7IDZ1618	16-18	3/8"	11 X 1	-
AB7IDZ1820	18-20	3/8"	11 X 1	-
AB7IDZ2022	20-22	1/2"	11 X 1	-
AB7IDZ2224	22-24	1/2"	11 X 1	-
AB7IDZ2628	26-28	3/4"	11 X 1	-

AB-PI

Grapa 1 pie

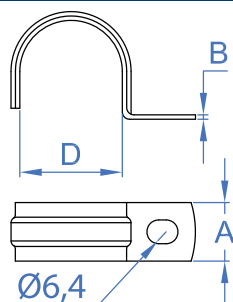

AB-PI

Abrazadera de un pie

CÓDIGO	ØD(MM)	ØD(")	A X B	CARGA MÁXIMA
ABPI006	6	-	12 x 1	30
ABPI008	8	-	12 x 1	30
ABPI010	10	1/8"	12 x 1	30
ABPI012	12	-	12 x 1	30
ABPI014	14	1/4"	15 x 1	30
ABPI016	16	-	15 x 1	30
ABPI018	18	3/8"	15 x 1	30
ABPI020	20	-	15 x 1	30
ABPI022	22	1/2"	15 x 1,2	30
ABPI025	25	-	15 x 1,2	30
ABPI026	26	3/4"	15 x 1,2	30
ABPI028	28	-	15 x 1,2	30
ABPI032	32	1"	15 x 1,2	30
ABPI040	40	-	15 x 1,2	30
ABPI042	42	1 1/4"	15 x 1,2	30
ABPI047	47	1 1/2"	15 x 1,2	30
ABPI050	50	-	15 x 1,2	30
ABPI063	63	2"	15 x 1,2	30

AB-PU

Grapa puente

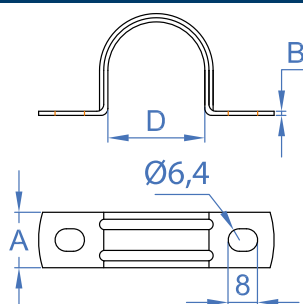

AB-PU

Abrazadera grapa puente

CÓDIGO	ØD(MM)	ØD(")	A X B	CARGA MÁXIMA
ABPU016	16	-	12 x 1,2	75
ABPU018	18	3/8"	12 x 1,2	75
ABPU020	20	-	12 x 1,2	75
ABPU022	22	1/2"	15 x 1,2	75
ABPU025	25	-	15 x 1,2	75
ABPU028	28	3/4"	15 x 1,2	75
ABPU032	32	1"	15 x 1,2	75
ABPU037	37	-	18 x 1,2	75
ABPU040	40	1 1/4"	18 x 1,2	75
ABPU050	50	1 1/2"	18 x 1,2	75
ABPU063	63	2"	18 x 1,2	75

AB-IP

Grapa puente isofónica para montaje

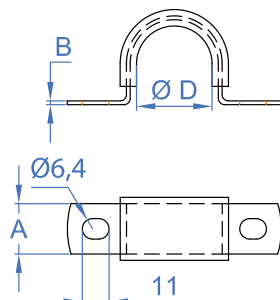

AB-IP

Abrazadera puente isofónica para montaje

CÓDIGO	ØD(MM)	ØD(")	A X B
ABIP015	15	1/4"	20 x 1,5
ABIP018	18	3/8"	20 x 1,5
ABIP022	22	1/2"	20 x 1,5
ABIP026	26	3/4"	20 x 1,5
ABIP028	28	-	20 x 1,5
ABIP035	35	1"	20 x 1,5
ABIP042	42	1 1/4"	20 x 1,5
ABIP048	48	1 1/2"	20 x 1,5
ABIP054	54	-	20 x 1,5
ABIP060	60	2"	20 x 1,5
ABIP067	67	-	20 x 1,5
ABIP075	75	2 1/2"	20 x 1,5
ABIP090	90	3"	20 x 1,5

AB-SI

Soporte para grapa puente isofónica

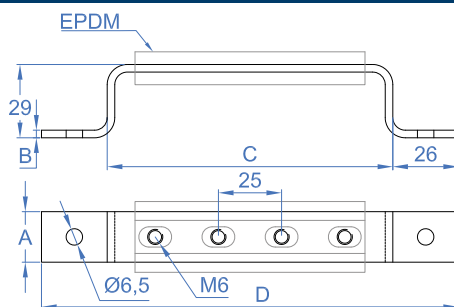

AB-SI

Soporte para grapa puente isofónica

CÓDIGO	A X B	C	D	Nº AGUJEROS
ABSI003	20 x 3	88	140	3
ABSI004	20 x 3	113	165	4
ABSI005	20 x 3	138	190	5
ABSI006	20 x 3	163	215	6
ABSI007	20 x 3	188	240	7
ABSI008	20 x 3	213	265	8
ABSI009	20 x 3	238	290	9
ABSI010	20 x 3	263	315	10
ABSI011	20 x 3	288	340	11
ABSI012	20 x 3	313	365	12
ABSI013	20 x 3	338	390	13
ABSI014	20 x 3	363	415	14
ABSI015	20 x 3	388	440	15
ABSI016	20 x 3	413	465	16
ABSI017	20 x 3	438	490	17
ABSI018	20 x 3	463	515	18
ABSI019	20 x 3	488	540	19
ABSI020	20 x 3	513	565	20
ABSI021	20 x 3	538	590	21
ABSI022	20 x 3	563	615	22
ABSI025	20 x 3	638	690	25

AB-SF

Abrazadera sin fin

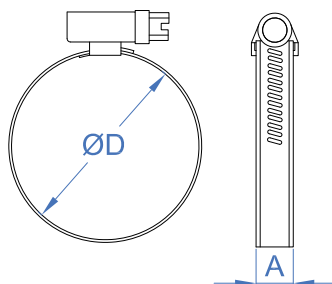

AB-SF

Cincada

CÓDIGO	ØD(MM)	ØD(")	AXB	PAR DE APRIETE
ASF008016	8-16	5/16" - 5/8"	9 x 0,7	4,5
ASF012022	12-22	1/2" - 7/8"	9 x 0,7	4,5
ASF016027	16 - 27	5/8" - 1 1/16"	9 x 0,7	4,5
ASF020032	20 - 32	3/4" - 1 1/4"	9 x 0,7	4,5
ASF025040	25 - 40	1" - 1 5/8"	9 x 0,7	4,5
ASF030045	30 - 45	1 3/16" - 1 3/4"	9 x 0,8	4,5
ASF035050	35 - 50	1 3/8" - 2"	9 x 0,8	4,5
ASF040060	40 - 60	1 5/8" - 2 3/8"	9 x 0,8	4,5
ASF050070	50 - 70	2" - 2 3/4"	9 x 0,8	4,5
ASF060080	60 - 80	2 3/8" - 3 1/8"	9 x 0,8	4,5
ASF070090	70 - 90	2 3/4" - 3 1/2"	9 x 0,8	4,5
ASF080100	80 - 100	3 1/8" - 4"	9 x 0,8	4,5
ASF090110	90 - 110	3 1/2" - 4 3/8"	9 x 0,8	4,5
ASF100120	100 - 120	4" - 4 3/4"	9 x 0,8	4,5
ASF110130	110 - 130	4 3/8" - 5 1/8"	9 x 0,8	4,5
ASF120140	120 - 140	4 3/4" - 5 1/2"	9 x 0,8	4,5
ASF130150	130 - 150	5 1/8" - 5 7/8"	9 x 0,8	4,5

AB-SF A2

Inoxidable A2

CÓDIGO	ØD(MM)	ØD(")	AXB	PAR DE APRIETE
ASF2010016	10-16	5/16" - 5/8"	9 x 0,7	4
ASF2012020	12-20	1/2" - 7/8"	9 x 0,7	4
ASF2016027	16 - 27	5/8" - 1 1/16"	9 x 0,7	4
ASF2020032	20 - 32	3/4" - 1 1/4"	9 x 0,7	4
ASF2025040	25 - 40	1" - 1 5/8"	9 x 0,7	4
ASF2032050	32 - 50	1 3/8" - 2"	9 x 0,7	4
ASF2040060	40 - 60	1 5/8" - 2 3/8"	9 x 0,7	4
ASF2050070	50 - 70	2" - 2 3/4"	9 x 0,7	4
ASF2060080	60 - 80	2 3/8" - 3 1/8"	9 x 0,7	4
ASF2070090	70 - 90	2 3/4" - 3 1/2"	9 x 0,7	4
ASF2080100	80 - 100	3 1/8" - 4"	9 x 0,7	4
ASF2090110	90 - 110	3 1/2" - 4 3/8"	9 x 0,7	4
ASF2100120	100 - 120	4" - 4 3/4"	9 x 0,7	4
ASF2110130	110 - 130	4 3/8" - 5 1/8"	9 x 0,7	4
ASF2120140	120 - 140	4 3/4" - 5 1/2"	9 x 0,7	4
ASF2130150	130 - 150	5 1/8" - 5 7/8"	9 x 0,7	4

CI-PE

Cinta perforada

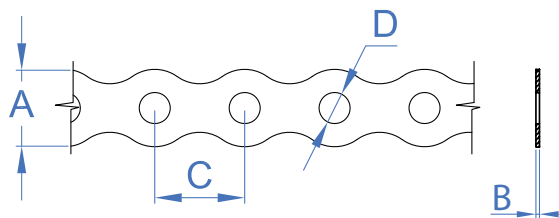

CI-PE

Cinta perforada curva. ATLANTIS C2-M

CÓDIGO	AXB	c	D
CIPE1208	12 x 0,8	14	5
CIPE1708	17 x 0,8	20	7

CI-PE A2

Cinta perforada curva. Inoxidable A2

CÓDIGO	AXB	c	D
CIPEA21708	17 x 0,8	20	7

CI-PR

Cinta perforada recta ATLANTIS C2-M

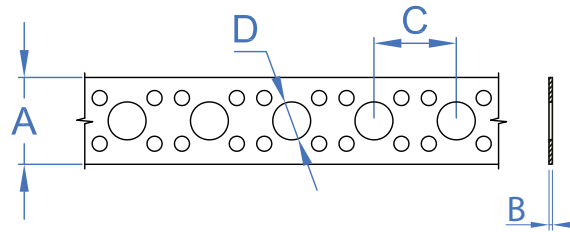

CI-PR

Cinta perforada recta ATLANTIS C2-M

CÓDIGO	A X B	c	D
CIPR1908	19 x 0,8	18	8,3
CIPR1208	12 x 0,8	12	6,2

AB-CR

Abrazadera cromada M6

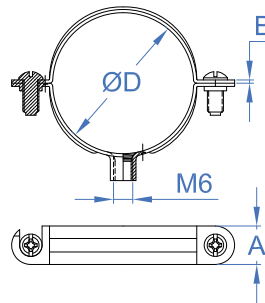

AB-CR

Abrazadera cromada M6

CÓDIGO	ØD(MM)	ØD(")	A X B	CARGA MÁXIMA
ABCR010	10	1/8"	12 x 1,2	70
ABCR012	12	1/4"	12 x 1,2	70

AB-BU

Abrazadera butano

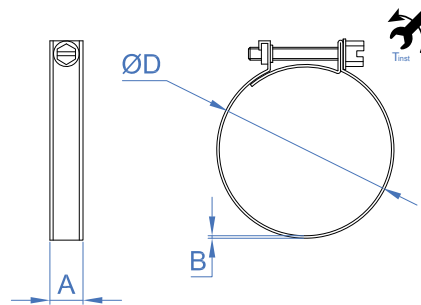

AB-BU

Abrazadera butano

CÓDIGO	ØD(MM)	ØD(")	A X B	PAR DE APRIETE
ABBU1315	13-15	1/2" - 9/16"	9 x 0,6	2
ABBU1618	16-18	5/8" - 11/16"	9 x 0,6	2
ABBU1921	19-21	3/4" - 13/16"	9 x 0,6	2

AB-GM

Abrazadera gásmica con tirafondo amarilla

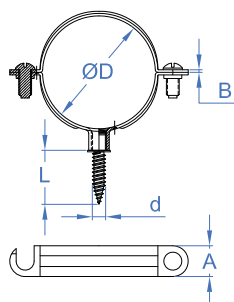

AB-GM

Abrazadera gásmica amarilla M6 con tirafondo

CÓDIGO	ØD(MM)	ØD(")	A X B	CARGA MÁXIMA
ABGM012	12	1/8"	12 x 1,2	70
ABGM015	15	1/4"	12 x 1,2	70
ABGM018	18	3/8"	12 x 1,2	70
ABGM022	22	1/2"	12 x 1,2	70
ABGM028	28	3/4"	12 x 1,2	70
ABGM035	35	1"	12 x 1,2	70

AB-GS

Abrazadera gásmica negra M6 con tirafondo

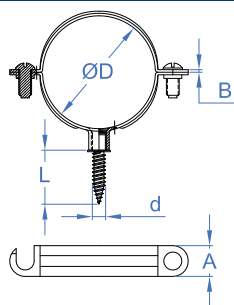

AB-GS

Abrazadera gásmica negra M6 con tirafondo

CÓDIGO	ØD(MM)	ØD(")	A X B	CARGA MÁXIMA
ABGS010	10	1/8"	12 x 1,2	70
ABGS012	12	-	12 x 1,2	70
ABGS015	15	1/4"	12 x 1,2	70
ABGS018	18	3/8"	12 x 1,2	70
ABGS022	22	1/2"	12 x 1,2	70
ABGS028	28	3/4"	12 x 1,2	70
ABGS035	35	1"	12 x 1,2	70
ABGS042	42	1 1/4"	12 x 1,2	100
ABGS054	54	-	12 x 1,2	100

AB-GD

Abrazadera gásmica negra doble M6 con tirafondo

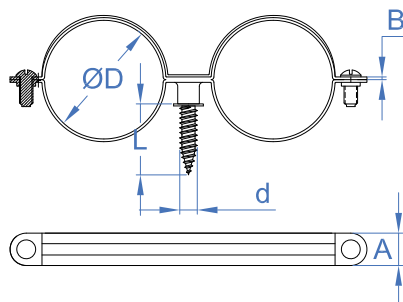

AB-GD

Abrazadera gásmica negra doble M6 con tirafondo

CÓDIGO	ØD(MM)	ØD(")	A X B	CARGA MÁXIMA
ABGD012	12	1/8"	12 x 1,2	100
ABGD015	15	1/4"	12 x 1,2	100
ABGD018	18	3/8"	12 x 1,2	100
ABGD022	22	1/2"	12 x 1,2	100
ABGD028	28	3/4"	12 x 1,2	100

AB-PE

Abrazadera colgante pera

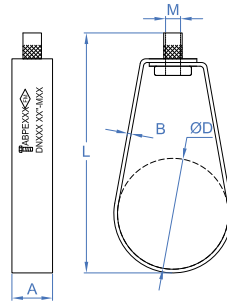

AB-PE

Abrazadera colgante pera

CÓDIGO	ØD(MM)	ØD(")	A X B	LONGITUD	MEDIDA TORNILLO	CARGA MÁXIMA
ABPE028	DN 20	3/4"	21 x 1	72	M10 (3/8")	154
ABPE035	DN 25	1"	21 x 1	78	M10 (3/8")	186
ABPE040	DN 32	1 1/4"	21 x 1	88	M10 (3/8")	195
ABPE048	DN 40	1 1/2"	21 x 1,2	95	M10 (3/8")	236
ABPE060	DN 50	2"	21 x 1,2	105	M10 (3/8")	288
ABPE075	DN 65	2 1/2"	21 x 1,2	125	M10 (3/8")	426
ABPE090	DN 80	3"	21 x 1,2	140	M10 (3/8")	481
ABPE100	DN 90	3 1/2"	21 x 1,2	160	M10 (3/8")	569
ABPE115	DN 100	4"	21 x 2	173	M10 (3/8")	669
ABPE140	DN 125	5"	30 x 2	209	M12 (1/2")	907
ABPE160	DN 150	6"	30 x 2,5	249	M12 (1/2")	1186
ABPE220	DN 200	8"	35 x 2,5	309	M12 (1/2")	1723

AB-CH

Abrazadera desagüe M8

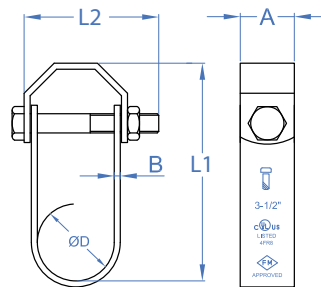

AB-CH

Abrazadera desagüe M8

CÓDIGO	ØD(MM)	ØD(")	A X B	L1	L2	CARGA MÁXIMA
ABCH00034	28	3/4"	22,5 x 2,5	82,5	50	153
ABCH01000	35	1"	22,5 x 2,5	99	57	172
ABCH01014	42	1 1/4"	22,5 x 2,5	106	70	196
ABCH01012	48	1 1/2"	22,5 x 2,5	107	75	239
ABCH02000	60	2"	25,5 x 2,5	126	90	290
ABCH02012	75	2 1/2"	26,0 x 3,0	156	110	385
ABCH03000	90	3"	26,0 x 3,0	169	115	484
ABCH04000	115	4"	30,0 x 4,0	200	15	673
ABCH05000	140	5"	32,0 x 4,5	231	200	913
ABCH06000	160	6"	36,5 x 4,5	260	225	1194
ABCH08000	220	8"	42,5 x 4,5	329	280	1836
ABCH10000	275	10"	44,5 x 6,0	381	360	2671
ABCH12000	325	12"	50,0 x 6,0	457	410	3608
ABCH14000	355	14"	50,0 x 6,0	514	465	4296
ABCH16000	405	16"	64,0 x 6,0	560	520	5572

AB-IN

Clip simple de polipropileno con casquillo de latón M6

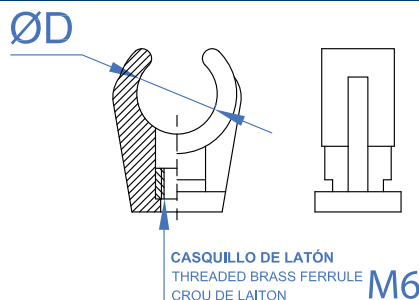

AB-IN

Clip simple de polipropileno con casquillo de latón M6

CÓDIGO	ØD(MM)	ØD(")	VÁLIDO PARA	CARGA MÁXIMA
ABIN012	12	1/4"	Carril 20/10	10
ABIN014	14-15	3/8"	Carril 20/10	10
ABIN016	16-18	-	Carril 20/10	10
ABIN020	20-22	-	Carril 20/10	10
ABIN025	25	-	Carril 20/10	10
ABIN028	28	3/4"	Carril 20/10	10
ABIN032	32	-	Carril 20/10	10
ABIN035	35	-	Carril 20/10	10

AB-ID

Clip doble de polipropileno con casquillo de latón M6

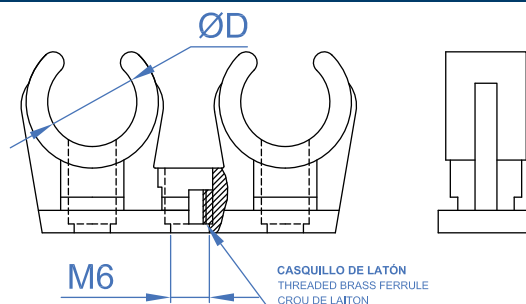

AB-ID

Clip doble de nylon (poliamida 6.6) con casquillo de latón M6

CÓDIGO	ØD(MM)	ØD(")	VÁLIDO PARA	CARGA MÁXIMA
ABID012	12	1/4"	Carril 20/10	10
ABID014	14-15	3/8"	Carril 20/10	10
ABID016	16-18	-	Carril 20/10	10
ABID020	20-22	-	Carril 20/10	10
ABID028	28	3/4"	Carril 20/10	10

AB-GU

Abrazadera guía simple con pre-rosca M6

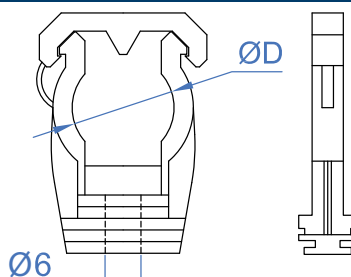

AB-GU

Abrazadera guía gris simple con pre-rosca M6

CÓDIGO	ØD(MM)	ØD(")	VÁLIDO PARA	CARGA MÁXIMA
ABGUG12	12	1/4"	20/10 27/18 28/30	40
ABGUG15	15	3/8"	20/10 27/18 28/30	40
ABGUG18	18	-	20/10 27/18 28/30	40
ABGUG20	20	-	20/10 27/18 28/30	40
ABGUG22	22	1/2"	20/10 27/18 28/30	40
ABGUG25	25	-	20/10 27/18 28/30	40
ABGUG28	28	-	20/10 27/18 28/30	40
ABGUG32	32	1"	20/10 27/18 28/30	40
ABGUG40	40	-	20/10 27/18 28/30	40
ABGUG50	50	-	20/10 27/18 28/30	40

AB-MUG

Abrazadera multidímetro

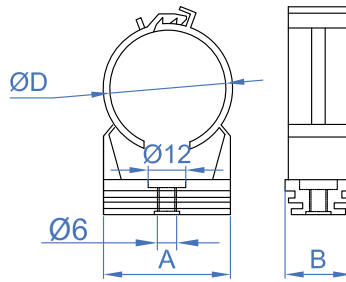

AB-MUG

Abrazadera multiusos

CÓDIGO	ØD(MM)	Ød(*)	A X B	VÁLIDO PARA	CARGA MÁXIMA
ABMUG12	12	-	17 x 20	20/10 27/18 28/30	40
ABMUG15	15	-	21 x 20	20/10 27/18 28/30	40
ABMUG18	18	-	25 x 20	20/10 27/18 28/30	40
ABMUG22	22	-	30 x 20	20/10 27/18 28/30	40
ABMUG26	26	-	33 x 20	20/10 27/18 28/30	40
ABMUG32	32	-	38 x 20	20/10 27/18 28/30	40
ABMUG40	40	-	46 x 20	20/10 27/18 28/30	40
ABMUG48	42	-	56 x 20	20/10 27/18 28/30	40

AB-PR

Abrazadera a presión con pre-roscas M6

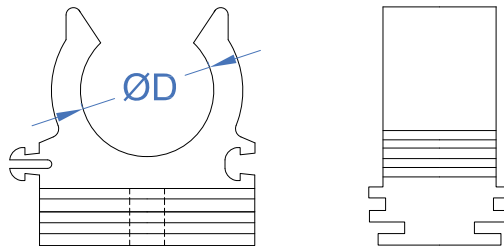

AB-PR

Gris

CÓDIGO	ØD(MM)	Ød(*)	VÁLIDO PARA	CARGA MÁXIMA
ABPRG15	15-18	3/8"	20/10 27/18 28/30	10
ABPRG20	20-22	-	20/10 27/18 28/30	10
ABPRG25	25-28	1/2"	20/10 27/18 28/30	10
ABPRG32	32-35	-	20/10 27/18 28/30	10
ABPRG40	40	-	20/10 27/18 28/30	10
ABPRG50	50	3/4"	20/10 27/18 28/30	10

AB-MS

Abrazadera multitubo + taco. Simple

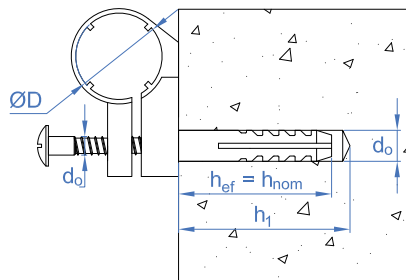

AB-MS

Abrazadera multitubo + taco. Simple

CÓDIGO	ØD(MM)	Ø BROCA	PROFUNDIDAD#MÍN. DE TALADRO	PROFUNDIDAD MIN. DEL#ANCLAJE	EXTRACCIÓN#HORMIGÓN NO-FISURADO	EXTRACCIÓN#LADRILLO HUECO	MEDIDA TORNILLO
ABMS10	10	5	30	20	9	5	3,5x35
ABMS12	12	5	30	20	9	5	3,5x35
ABMS14	14	6	35	25	15	8	4x45
ABMS16	16	6	35	25	15	8	4x45
ABMS18	18	8	45	30	16	12	4,5x50
ABMS20	20	8	45	30	16	12	4,5x50
ABMS22	22	8	45	30	16	12	4,5x50
ABMS26	26	10	50	40	30	15	6x60
ABMS28	28	10	50	40	30	15	6,5x60

AB-MD

Abrazadera multitubo + taco. Doble

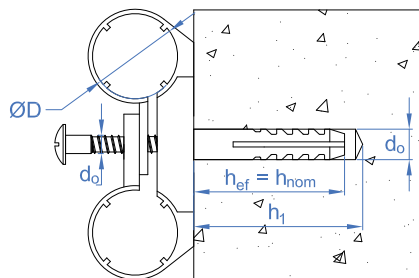

AB-MD

Abrazadera multitubo + taco. Doble

CÓDIGO	ØD(MM)	Ø BROCA	PROFUNDIDAD MÍN. DE TALADRO	PROFUNDIDAD MÍN. DEL ANCLAJE	EXTRACCIÓN HORMIGÓN NO-FISURADO	EXTRACCIÓN LADRILLO HUECO	MEDIDA TORNILLO
ABMD10	10	8	60	30	16	12	4,5x50
ABMD12	12	8	60	30	16	12	4,5x50
ABMD14	14	8	60	30	16	12	4,5x50
ABMD16	16	8	60	30	16	12	4,5x50
ABMD18	18	10	70	40	30	15	6x60
ABMD20	20	10	70	40	30	15	6x60
ABMD22	22	10	70	40	30	15	6x60
ABMD26	26	10	70	40	30	15	6x60
ABMD28	28	10	70	40	30	15	6x60

AB-T

Taco para fijación de tubo INDEXring

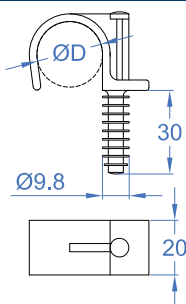

AB-TS

Simple

CÓDIGO	ØD(MM)	ØD('')	CARGA MÁXIMA
ABTS014	14 - 15	-	30
ABTS016	16 - 17	3/8"	30
ABTS018	18 - 19	-	30
ABTS020	20 - 21	1/2"	30
ABTS022	22 - 23	-	30
ABTS025	25 - 26	3/4"	30
ABTS028	28 - 29	-	30
ABTS032	30 - 32	-	30

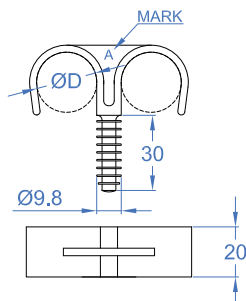

AB-TD

Doble

CÓDIGO	ØD(MM)	ØD('')	CARGA MÁXIMA
ABTD016	15 - 16	3/8"	30
ABTD018	18 - 19	-	30
ABTD020	20 - 21	1/2"	30
ABTD022	22 - 23	-	30
ABTD025	25 - 26	3/4"	30
ABTD028	28 - 29	-	30

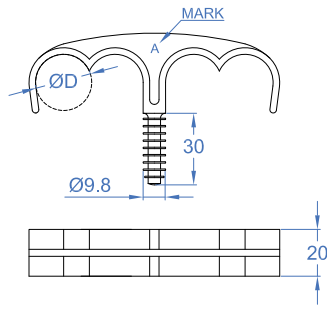

AB-TC

Cuádruple

CÓDIGO	ØD(MM)	ØD(")	CARGA MÁXIMA
ABTC020	20 - 21	1/2"	30
ABTC025	25 - 26	3/4"	30

SU

Sistemas de fijación rápida en viga

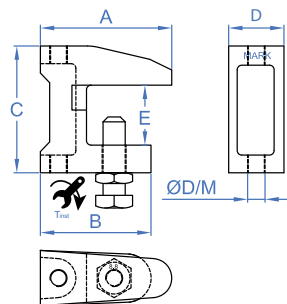

SU-MO

Mordaza para viga

CODIGO	A	B	C	D	E	PAR DE APRIETE	LLAVE DE INSTALACIÓN (SW)	ØD (MM)	MEDIDA TORNILLO
SUMOP09	38	35	37	18	20	10	13	PASANTE Ø9	M8 x 35
SUMOP11	44	41	42	21	20	15	17	PASANTE Ø11	M10 x 40
SUMOP13	58	48	54	24	25	15	17	PASANTE Ø13	M10 x 50
SUMOM06	38	35	37	18	20	10	13	ROSCADO M6	M6 x 35
SUMOM08	38	35	37	18	20	10	13	ROSCADO M8	M8 x 35
SUMOM10	44	41	42	21	20	15	17	ROSCADO M10	M10 x 40
SUMOM12	58	48	54	24	25	15	17	ROSCADO M12	M10 x 50

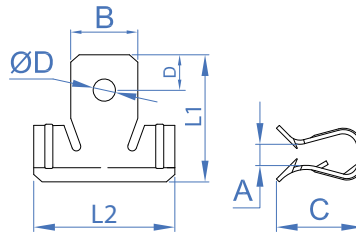

SU-CL

Clip de suspensión

CODIGO	A	B	C	D	L1	L2	ØD(MM)
SUCL02	1,5 - 4	13	14	10	28	28	6.3
SUCL04	4 - 10	19	23	10	34	40	6.3
SUCL10	10 - 15	19	23	10	40	40	6.3
SUCL15	15 - 20	19	23	10	40	40	6.3

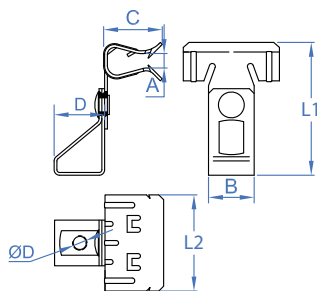

SU-VA

Clip varilla

CODIGO	A	B	C	D	L1	L2	ØD (MM)
SUVA0602	1,5 - 4	19	14	21	50	28	M6
SUVA0604	4 - 10	19	23	21	54	40	M6
SUVA0610	10 - 15	19	23	21	60	40	M6
SUVA0615	15 - 20	19	23	21	60	40	M6
SUVA0804	1,5 - 4	19	14	21	50	28	M8
SUVA0810	4 - 10	19	23	21	54	40	M8
SUVA0815	10 - 15	19	23	21	60	40	M8
SUVA0802	15 - 20	19	23	21	60	40	M8

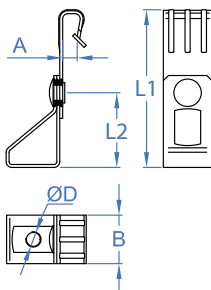

SU-CU

Clip de cuelgue

CODIGO	A	B	L1	L2	ØD (MM)
SUCU0602	1,5 - 5	19	65	30	M6
SUCU0605	5 - 7	19	65	30	M6
SUCU0606	3 - 7	19	80	30	M6
SUCU0607	7 - 10	19	95	30	M6

SU-AB

Clip de viga para abrazadera

CÓDIGO	ESPEJOR MÁX. A FIJAR	ANCHO MÁX. DE VIGA	ØD(MM)	H1	H3	MEDIDA TORNILLO
SUAB0603	3 - 7	36,5	M6	30	36,5	M6x9
SUAB0607	7 - 13	36,5	M6	36	36,5	M6x9
SUAB0614	14 - 20	36,5	M6	43	36,5	M6x9

SU-CA

Clip de viga para cable

CÓDIGO	ESPEJOR MÁX. A FIJAR	ØD(MM)	GROSOR
SUCA0602	1 - 4	6-7	0,6
SUCA0604	4 - 7,5	6-7	0,6
SUCA0607	7,5 - 12	6-7	0,6
SUCA0802	1 - 4	8-9	0,6
SUCA0804	4 - 7,5	8-9	0,6
SUCA0807	7,5 - 12	8-9	0,6
SUCA1002	1 - 4	10-11	0,6
SUCA1004	4 - 7,5	10-11	0,6
SUCA1007	7,5 - 12	10-11	0,6
SUCA1202	1 - 4	12-14	0,6
SUCA1204	4 - 7,5	12-14	0,6
SUCA1207	7,5 - 12	12-14	0,6
SUCA1502	1 - 4	15-18	0,6
SUCA1504	4 - 7,5	15-18	0,6
SUCA1507	7,5 - 12	15-18	0,6
SUCA1902	1 - 4	19-24	0,6
SUCA1904	4 - 7,5	19-24	0,6
SUCA1907	7,5 - 12	19-24	0,6
SUCA2502	1 - 4	25-30	0,6
SUCA2504	4 - 7,5	25-30	0,6
SUCA2507	7,5 - 12	25-30	0,6

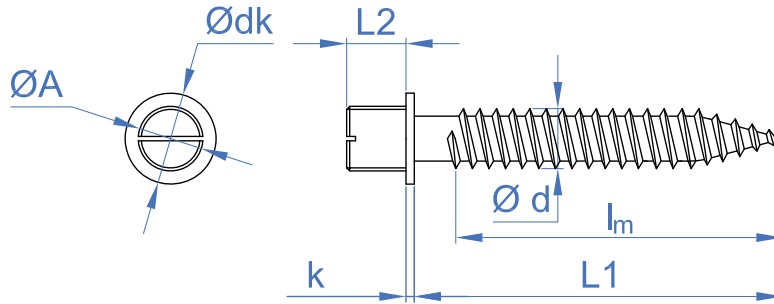

AB-TA

Cincado. Ranurado

CODIGO	METRICA	ØD	L1	L2	K	ØDK	LONGITUD DE ROSCA
ABTA0630	M6	5	30	6	1	8	30
ABTA0640	M6	5	40	6	1	8	40
ABTA0650	M6	5	50	6	1	8	50
ABTA0730	M7	6	22	6	1	9,5	-
ABTA0740	M7	6	32	6	1	9,5	-
ABTA0750	M7	6	42	6	1	9,5	-
ABTA0760	M7	6	52	6	1	9,5	-
ABTA0770	M7	6	62	6	1	9,5	-
ABTA0780	M7	6	72	6	1	9,5	-
ABTA0840	M8	6	40	7,5	1,4	8,5	40
ABTA0860	M8	6	60	7,5	1,4	8,5	60
ABTA0880	M8	6	80	7,5	1,4	8,5	45
ABTA1050	M10	8	50	9	1,7	12	50
ABTA1070	M10	8	70	9	1,7	12	45
ABTA1090	M10	8	90	9	1,7	12	45

AB-TA B

Bicromatado. Ranurado

CODIGO	METRICA	ØD	L1	L2	K	ØDK	LONGITUD DE ROSCA
ABTAB0630	M6	5	30	6	1	8	30
ABTAB0640	M6	5	40	6	1	8	40
ABTAB0650	M6	5	50	6	1	8	50

AB-TA A2

Inoxidable A2. Ranurado

CODIGO	METRICA	ØD	L1	L2	K	ØDK	LONGITUD DE ROSCA
ABTA20630	M6	5	30	7	1,2	7,8	30

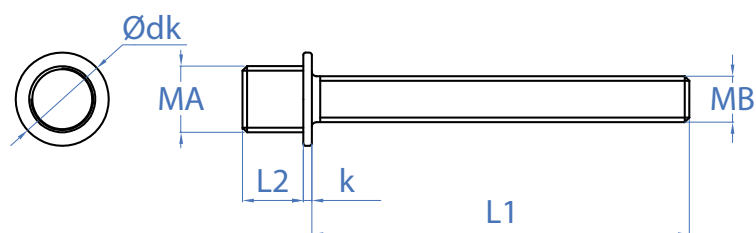

AB-TR

Tornillo doble para abrazaderas

CODIGO	METRICA	L1	L2	K	ØDK
ABTR05030	M7	30	6	1	9
ABTR05040	M7	40	6	1	9
ABTR05050	M7	50	6	1	9
ABTR05060	M7	60	6	1	9
ABTR06040	M7	40	6	1	9
ABTR06050	M7	50	6	1	9
ABTR06060	M7	60	6	1	9

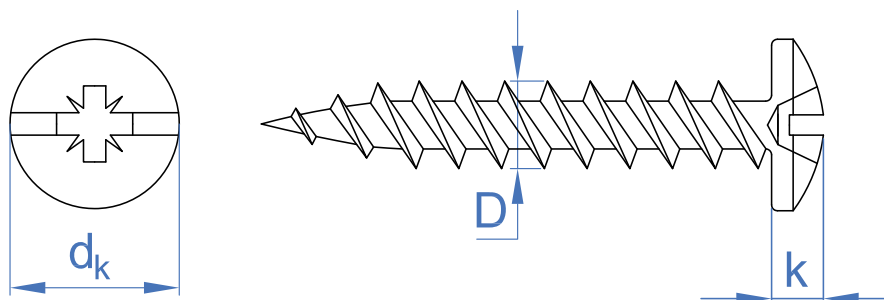

AB-TG

Tirafondo grapa. Huella combi

CODIGO	LONGITUD	LLAVE DE INSTALACION	ØDK	K	ØD(MM)ØD
ABTG4530	30	PZ2	10	3	4,5
ABTG4535	35	PZ2	10	3	4,5
ABTG4540	40	PZ2	10	3	4,5
ABTG5030	30	PZ3	12	3	5
ABTG5040	40	PZ3	12	3	5

ES-DR

Espárrago de doble rosca

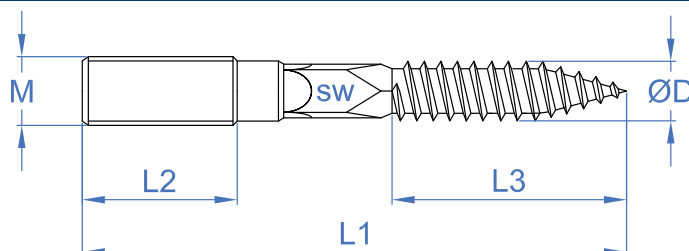

ES-DR

Cincado. Tx

CODIGO	METRICA	LONGITUD	ØD(MM)	LLAVE DE INSTALACIÓN (SW)	L1	L2	L3
ESDR06040	M6	40	6	-	40	12	24
ESDR06050	M6	50	6	-	50	16	28,5
ESDR06060	M6	60	6	-	60	18	34,5
ESDR06070	M6	70	6	-	70	26	34,5
ESDR06080	M6	80	6	-	80	34	34,5
ESDR08050	M8	50	7	-	50	13	29,5
ESDR08060	M8	60	7	-	60	15	37,5
ESDR08070	M8	70	7	-	70	25	37,5
ESDR08080	M8	80	7	6	80	28,5	37,5
ESDR08090	M8	90	7	6	90	28,5	48,5
ESDR08100	M8	100	7	6	100	33,5	48,5
ESDR08110	M8	110	7	6	110	42,5	48,5
ESDR08120	M8	120	7	6	120	50	48,5
ESDR08130	M8	130	7	6	130	50	48,5
ESDR10080	M10	80	8	8	80	18	46,5
ESDR10100	M10	100	9	8	100	24	57
ESDR10110	M10	110	9	8	110	38	57
ESDR10120	M10	120	9	8	120	45	57
ESDR10130	M10	130	9	8	130	50	57
ESDR10140	M10	140	9	8	140	50	57
ESDR10150	M10	150	9	8	150	50	57
ESDR10180	M10	180	9	8	180	50	57
ESDR10200	M10	200	9	8	200	50	57

ES-DA2

Inoxidable A2. Tx

CODIGO	METRICA	LONGITUD	ØD(MM)	LLAVE DE INSTALACIÓN (SW)	L1	L2	L3
ESDA208060	M8	60	7	6	60	20	30
ESDA210060	M10	60	9	8	60	20	30

GAMA DE ELEMENTOS DE SOPORTACIÓN

CÓDIGO	DESCRIPCION	MATERIAL	RECUBRIMIENTO
GPZ201010	Carril 20 x 10 x 1	A	Z
GPZ250808	Carril 25 x 8 x 0,80	A	Z
GPG271812	Carril 27 x 18 x 1,25	A	Z
GPG283018	Carril 28 x 30 x 1,80	A	Z
GPG384020	Carril 38 x 40 x 2,00	A	Z
GPG351312	Carril 35 x 12 x 1,20	A	Z
GPG402015	Carril 40 x 20 x 1,50	A	Z
GPI271812	Carril 27 x 18 x 1,25	A2 INOX	Z
GPI283015	Carril 28 x 30 x 1,50	A	Z
GPP271812	Carril 27 x 18 x 1,25	A	Z
GPV251120	Carril 25 x 11 x 2,00	PVC	Z
GPO357510	Guía Omega perforada/lisa cincada	A	Z
GPO351515		A	Z
GLO357510		A	Z
GLO351515		A	Z
SPZ271820	Soporte 27 x 18 x 1,20 x 200	A	Z
SPZ271830	Soporte 27 x 18 x 1,20 x 300		
SPZ384020	Soporte 38 x 40 x 2,00 x 200		
SPZ384025	Soporte 38 x 40 x 2,00 x 250		
SPZ384030	Soporte 38 x 40 x 2,00 x 300		
SPZ384035	Soporte 38 x 40 x 2,00 x 350		
SPZ384040	Soporte 38 x 40 x 2,00 x 400		
SPZ384050	Soporte 38 x 40 x 2,00 x 500		
SPZ384060	Soporte 38 x 40 x 2,00 x 600		
SPV2718	Soporte vertical		
SPH2718	Soporte horizontal	A	Z
SPH3840		A	Z
SPGH2718	Soporte horizontal carriles	A	Z
SPGH3840		A	Z
TG230620	Tope tornillo guía perforada	A	Z
TG230820		A	Z
TG230830		A	Z
TG340830		A	Z
TG41030		A	Z
TUG201006	Tuerca guía perforada	A	Z
TUG201008		A	Z
TUG271808		A	Z
TUG271810	Tuerca guía con arandela fijación rápida	A	Z
TUGRA2706		A	Z
TUGRA2708		A	Z
TUGRA3808		A	Z
TUGRA3810		A	Z
TGR230620	Tope-tornillo guía de fijación rápida	A	Z
TGR230820		A	Z
TGR230830		A	Z
TGR340830		A	Z
TGR341030		A	Z
EMZ45	Escuadras cincadas e inoxidables	A	Z
EMZ90		A	Z
EMZ00		A	Z
EMI45		A2 INOX	Z
EMI90		A	Z
EMIO0		A	Z
PGZ2718	Puente guía cincado e inoxidable	A	Z
PGZ2830		A	Z
PGZ3840		A	Z
PGI2718		A2 INOX	Z
PGI2830		A	Z
PGI3840	Placa de unión para perfiles	A	Z
PUZ2718		A	Z
PUZ3840		A	Z
SOTP2718	Tapón plástico para soportación	FURNACE HISTORICAL	Z
SOTP2830		FURNACE HISTORICAL	Z
SOTP3840		FURNACE HISTORICAL	Z
SOTP4121		FURNACE HISTORICAL	Z
SOTP4141		FURNACE HISTORICAL	Z
SOPG27	Cubierta de goma para soportación	EPDM	Z
SOPG38		EPDM	Z
SOPG41		EPDM	Z

CÓDIGO	DESCRIPCION	MATERIAL	RECUBRIMIENTO		
GPX412115	Carril 41 x 21 x 1,50	A	Z		
GPX412120	Carril 41 x 21 x 2,00				
GPX412125	Carril 41 x 21 x 2,50				
GPX414115	Carril 41 x 41 x 1,50				
GPX414120	Carril 41 x 41 x 2,00				
GPX414125	Carril 41 x 41 x 2,50				
GPX2M412120	Carril 41 x 21 x 2,00				
GPX2M414120	Carril 41 x 41 x 2,00				
SPX412115	Soporte 41 x 21 x 2,50 x 150			A	Z
SPX412130	Soporte 41 x 21 x 2,50 x 300				
SPX412145	Soporte 41 x 21 x 2,50 x 450				
SPX414115	Soporte 41 x 41 x 2,50 x 150				
SPX414130	Soporte 41 x 41 x 2,50 x 300				
SPX414145	Soporte 41 x 41 x 2,50 x 450				
SPX414160	Soporte 41 x 41 x 2,50 x 600				
SPX414175	Soporte 41 x 41 x 2,50 x 750				
SPX414110	Soporte 41 x 41 x 2,50 x 1000				
SPGH3840	Soporte horizontal	A	Z		
PRX01	Soporte regulable para perfil INDETRUT	A	Z		
SPRXH4121	Soporte base rectangular U INDETRUT	A	Z		
SPRXV4121		A	Z		
SPUX412100	Soporte base U INDETRUT	A	Z		
SPUX412145		A	Z		
ABGX4121	Abrazadera guía perforada INDETRUT	A	Z		
EMPX4121	Empalme para perfiles INDETRUT	A	Z		
RESX300	Refuerzo soportes INDETRUT	A	Z		
RESX550		A	Z		
RTX01	Soporte rotula INDETRUT	A	Z		
EMX9002	Escuadras cincadas INDETRUT	A	Z		
EMX9004		A	Z		
EMX4502		A	Z		
EMX1302	Puente guía INDETRUT	A	Z		
PGX4121		A	Z		
PGX4141		A	Z		
UNEX412103	Unión escuadra/placa T INDETRUT	A	Z		
UNPX42101		A	Z		
UNPX42102		A	Z		
UNPX42103		A	Z		
UNPX42104		A	Z		
UNTX412104	Escuadra reforzada INDETRUT	A	Z		
SCRX090		A	Z		
TUGX08		Tuerca guía perforada	A	Z	
TUGX10	Tuerca guía con muelle INDETRUT	A	Z		
TUGXMU08		A	Z		
TUGXMU10	Tope-tornillo guía INDETRUT	A	Z		
TGX0840		A	Z		
TGX0860		A	Z		
TGX1040		A	Z		
TGX1060	Tuerca fijación rápida INDETRUT	A	Z		
TURX08		A	Z		
TURX10		A	Z		
TURX12	Tuerca INDETRUT con arandela de fijación rápida	A	Z		
TURXA08		A	Z		
TURXA10		A	Z		
TGRX0830	Tope guía INDETRUT de fijación rápida	A	Z		
TGRX0860		A	Z		
TGRX1030		A	Z		
TGRX1060	Patín de expansion	A	Z		
PAEXM08		A	Z		
PAEXM10		A	Z		
SOTP4121	Tapón plástico para soportación	FURNACE HISTORICAL	Z		
SOTP4141		FURNACE HISTORICAL	Z		
SOPG41	Cubierta de goma para soportación	EPDM	Z		

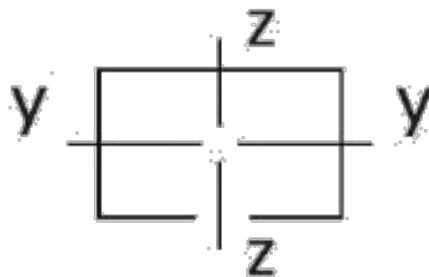
ASPECTOS GEOMÉTRICOS

CÓDIGO	SECCIÓN	PESO	ÁREA	MOMENTO INERCIA (I _y)	MOMENTO INERCIA (I _z)	MÓDULO RESISTENTE (W _y)	MÓDULO RESISTENTE (W _z)
	[mm x mm]	[Kg/m]	[cm ²]	[cm ⁴]	[cm ⁴]	[cm ³]	[cm ³]
GPZ201010	20 x 10	0.31	0.44	0.06	0.25	0.10	0.25
GPZ250808	25 x 8	0.26	0.35	0.03	0.30	0.06	0.24
GPG271812	27 x 18	0.66	0.84	0.37	0.97	0.34	0.71
GPG283018	28 x 30	1.25	1.60	1.79	2.10	1.03	1.50
GPG384020	38 x 40	2.00	2.55	5.39	6.18	2.39	3.25
GPG402015	40 x 20	0.94	1.30	0.71	3.10	0.57	1.55
GPP271812	27 x 18	0.66	0.84	0.37	0.97	0.34	0.71
GPI271812	27 x 18	0.66	0.79	0.36	0.90	0.33	0.67
GPI283015	28 x 30	1.25	1.37	1.54	1.82	0.89	1.30
GPX412115	41 x 21	1.21	1.41	0.89	3.58	0.70	1.75
GPX412120	41 x 21	1.55	1.99	0.95	4.44	0.75	2.17
GPX412125	41 x 21	1.71	2.28	1.32	5.54	1.03	2.70
GPX414115	41 x 41	1.65	2.42	4.88	5.99	2.05	2.92
GPX414120	41 x 41	2.09	2.65	5.84	7.62	2.46	3.72
GPX414125	41 x 41	2.53	3.28	7.08	9.25	2.98	4.51
GPX2M412120	41 x 21	1.55	1.99	0.95	4.44	0.75	2.17
GPX2M414120	41 x 41	2.09	2.65	5.84	7.62	2.46	3.72
SPZ271820	27 x 18	1,2	0.84	0.37	0.97	0.34	0.71
SPZ271830	27 x 18	1,2	0.84	0.37	0.97	0.34	0.71
SPZ384020	38 x 40	2,4	2.55	5.39	6.18	2.39	3.25
SPZ384025	38 x 40	2,4	2.55	5.39	6.18	2.39	3.25
SPZ384030	38 x 40	2,4	2.55	5.39	6.18	2.39	3.25
SPZ384035	38 x 40	2,4	2.55	5.39	6.18	2.39	3.25
SPZ384040	38 x 40	2,4	2.55	5.39	6.18	2.39	3.25
SPZ384050	38 x 40	2,4	2.55	5.39	6.18	2.39	3.25
SPZ384060	38 x 40	2,4	2.55	5.39	6.18	2.39	3.25
SPX412115	41 x 21	1,88	2.28	1.32	5.54	1.03	2.70
SPX412130	41 x 21	1,88	2.28	1.32	5.54	1.03	2.70
SPX412145	41 x 21	1,88	2.28	1.32	5.54	1.03	2.70
SPX414115	41 x 41	2,7	3.28	7.08	9.25	2.98	4.51
SPX414130	41 x 41	2,7	3.28	7.08	9.25	2.98	4.51
SPX414145	41 x 41	2,7	3.28	7.08	9.25	2.98	4.51
SPX414160	41 x 41	2,7	3.28	7.08	9.25	2.98	4.51
SPX414175	41 x 41	2,7	3.28	7.08	9.25	2.98	4.51
SPX414110	41 x 41	2,7	3.28	7.08	9.25	2.98	4.51

RED COMERCIAL ESPAÑA

ÁLAVA

Mikel Paredes
mparedes@indexfix.com
Tfno. 679 559 519

ALBACETE

Antonio Álvarez
a.alvarezmegias@gmail.com
Tfno. 678 537 861

ALICANTE

Valentín Ramos
representacionesvalentin@gmail.com
Tfno. 606 305 980
Maxi Flores
Tfno. 647 447 793

ALMERÍA

José Plaza
jplazagonzalez1@gmail.com
Tfno. 608 956 641

ANDORRA

Pere Soro
peresoro@gmail.com
Tfno. 609 363 693

ASTURIAS

David Blanco
dblancos@indexfix.com
Tfno. 680 748 731

ÁVILA

Vicente Beltrán
vicentebeltran@telefonica.net
Tfno. 609 616 926

BADAJOS

Rafael Córdoba
rcordoba@indexfix.com
Tfno. 648 068 528

BALEARES

Antonio Forteza
repforpa@gmail.com
Tfno. 636 973 665
Agustín Forteza
repforteza@gmail.com
Tfno. 660 725 880

BARCELONA

Jose Ramón Tello
jrtello@indexfix.com
Tfno. 619 033 535
Roger Rosell
rrosell@indexfix.com
Tfno. 618 361 743

BURGOS

Óscar Aliende
oaliende@indexfix.com
Tfno. 629 777 206

CÁCERES

Rafael Córdoba
rcordoba@indexfix.com
Tfno. 648 068 528

CÁDIZ

José Antonio Prieto
prietocadiz@yahoo.es
Tfno. 667 552 000

CADIZ - CAMPO DE GIBRALTAR

Luis Fernando Reguera
luis@representacionesreguera.com
Tfno. 696 416 886

CANARIAS

Alfredo Carrancio Sosa
acarrancio@indexfix.com
Tfno. 600 462 930

CANTABRIA

Mikel Paredes
mparedes@indexfix.com
Tfno. 679 559 519

CASTELLÓN

Francisco Blasco
representacionesblasco@gmail.com
Tfno. 639 672 267

CEUTA

Luis Fernando Reguera
luis@representacionesreguera.com
Tfno. 696 416 886

CIUDAD REAL

Vicente Beltrán
vicentebeltran@telefonica.net
Tfno. 609 616 926

CÓRDOBA

Rafael Córdoba
rcordoba@indexfix.com
Tfno. 648 068 528

CUENCA

Vicente Beltrán
vicentebeltran@telefonica.net
Tfno. 609 616 926

GIRONA

Joan Caldas
j.caldas@cgac.es
Tfno. 629 314 169

GRANADA

Ismael Marco
ismaelmarcorios@gmail.com
Tfno. 670 242 337
Armando Ríos
Tfno. 670 453 269

GUADALAJARA

Vicente Beltrán
vicentebeltran@telefonica.net
Tfno. 609 616 926

GUIPÚZCOA

Koldo Balda González
baldas@yahoo.es
Tfno. 629 476 660

HUELVA

Jose M^o Castillo
jmcastillo@yahoo.es
Tfno. 667 769 427

HUESCA

Fernando Gonzalo
fgonzalo@fgmsl.es
Tfno. 609 879 313

JAEN

Ismael Marco
ismaelmarcorios@gmail.com
Tfno. 670 242 337
Armando Ríos
Tfno. 670 453 269

LA CORUÑA

Carlos Seoane
cseoane@indexfix.com
Tfno. 618 614 872

LA RIOJA

Álvaro Bartolomé
abartolome@indexfix.com
Tfno. 608 278 355

LEÓN

Francisco Viñuela
pacovinelaleon@hotmail.com
Tfno. 670 597 272

LLEIDA

Pere Soro
peresoro@gmail.com
Tfno. 609 363 693

LUGO

Carlos Seoane
cseoane@indexfix.com
Tfno. 618 614 872

MADRID

Sergio de Miguel
sdemiguel@indexfix.com
Tfno. 608 566 769
Álvar Martín
amartin@indexfix.com
Tfno. 630 175 362
Cristina Conde
cconde@indexfix.com
Tfno. 638 547 099

MÁLAGA

Antonio J. Martín
repmartin@hotmail.com
Tfno. 610 701 604
Enrique Martín
Tfno. 667 574 316

MELILLA

José Plaza
jplazagonzalez1@gmail.com
Tfno. 608 956 641

MURCIA

Facundo Cuenca e Hijos, S.L.
info@facundocuenca.com
Tfno. 968 898 167

NAVARRA

Eduardo Pellejero
epellejero@telefonica.net
Tfno. 658 842 592

ORENSE

Carlos Seoane
cseoane@indexfix.com
Tfno. 618 614 872

PALENCIA

Óscar Aliende
oaliende@indexfix.com
Tfno. 629 777 206

PONTEVEDRA

Carlos Seoane
cseoane@indexfix.com
Tfno. 618 614 872

SALAMANCA

Javier Vecino
javiervecino@hotmail.com
Tfno. 609 811 878

SEGOVIA

Vicente Beltrán
vicentebeltran@telefonica.net
Tfno. 609 616 926

SEVILLA

José Antonio Bonilla
jabonilla@jabonilla.es
Tfno. 607 433 102

SORIA

Comercial Arrieta C.B.
gorka_arrieta@yahoo.es
Tfno. 619 416 914

TARRAGONA

Pau Pérez
pperez@indexfix.com
620 504 077

TERUEL

Fernando Gonzalo
fgonzalo@fgmsl.es
Tfno. 609 879 313

TOLEDO

Vicente Beltrán
vicentebeltran@telefonica.net
Tfno. 609 616 926

VALENCIA

Francisco Blasco
representacionesblasco@gmail.com
Tfno. 639 672 267

VALLADOLID

Javier Vecino
javiervecino@hotmail.com
Tfno. 609 811 878

VIZCAYA

Mikel Paredes
mparedes@indexfix.com
Tfno. 679 559 519

ZAMORA

Francisco Viñuela
pacovinelaleon@hotmail.com
Tfno. 670 597 272

ZARAGOZA

Fernando Gonzalo
fgonzalo@fgmsl.es
Tfno. 609 879 313

PRESENCIA INTERNACIONAL



FRANCIA - Aquitania, Languedoc-Rosellón, Lemosín, Mediodía-Pirineos
Thierry Nouvel - T-Nouvel
t-nouvel@indexfix.com
+ 33 (0) 608.578.114

FRANCIA - Auvernia, Borgoña, Centro, Ródano-Alpes
Sales-up
Pierre Broizart
pbrozart@indexfix.com
+ 33 (0) 665.493.382

FRANCIA - Bretaña, Países del Loira
Rodolphe Hirn - STE Hirn Representations
rhirn@indexfix.com
+ 33 (0) 676.282.469

FRANCIA - Isla de Francia
Geoffroy Ehlinger
gehlinger@indexfix.com
+ 33 (0) 675.474.552

FRANCIA - Córcega
Noel Stromboni
nstromboni@indexfix.com
+ 33 (0) 67.163.2326

FRANCIA - DOM TOM
Jacques Vergé
jverge@indexfix.com
+ 33 (0) 468.691.968

FRANCIA - PACA
Jean Vivien - SD-PRO
contact.sdpro@free.fr
+33 (0) 607.853.297

FRANCIA - GRAND EST
Frederic Koenig
fred.koenig@outlook.fr
+ 33 (0) 633454230

ALEMANIA
Dieter Fernandez
dfernandez@indexfix.com
+ 49 (0) 171 27 64 898

ITALIA
Sansone Rappresentanza
sansonerappresentanza@gmail.com
+39 3925804863

Julio Gonzalez
jgonzalez@indexfix.com
+39 3283764305

RUMANÍA
Dacian Lupu
dlupu@indexfix.com
+ 40 775 197 970

SENEGAL / COSTA DE MARFIL
BENIN / CAMERÚN / GABÓN / CONGO
Jacques Vergé
jverge@indexfix.com
+ 33 (0) 468.691.968

MARRUECOS
NOUMAREP
Brahim Nouçair
noucair@indexfix.com
+ 212 (0) 122.230.2127

PORTUGAL
Marco Sousa
marcosousa@indexfix.com
+ 351 913.908.536

GRECIA
M.I. SASSON & CO O.E.
msaso@indexfix.com
+ 30 6932 406 106

ALEMANIA
ARABIA SAUDITA
ARGELIA
AUSTRALIA
AUSTRIA
BANGLADESH
BÉLGICA
BENÍN
BOLIVIA
BOSNIA
BULGARIA
CAMERÚN
CHIPRE
COLOMBIA
CONGO
COSTA DE MARFIL
CROACIA
CUBA
DINAMARCA
EGIPTO
EMIRATOS ÁRABES
ESCOCIA
ESLOVENIA
ESTADOS UNIDOS
ESTONIA
FINLANDIA
FRANCIA
GABÓN
GRECIA
GUAYANA FRANCESA
GUINEA ECUATORIAL
HOLANDA
HONDURAS
HUNGRÍA
INDIA
INDONESIA
INGLATERRA
IRÁN
IRLANDA
IRLANDA DEL NORTE
ISLA GUADALUPE
ISLANDIA
ISRAEL
ITALIA
KOSOVO
KUWAIT
LETONIA
LÍBANO
LITUANIA
LUXEMBURGO
MACEDONIA
MADAGASCAR
MALTA
MARRUECOS
MARTINICA
MAURICIO
MÉXICO
MONTENEGRO
NORUEGA
NUEVA CALEDONIA
OMÁN
PAKISTÁN
PANAMÁ
PERÚ
POLINESIA FRANCESA
POLONIA
PORTUGAL
QATAR
REPUBLICA CHECA
REPUBLICA DOMINICANA
REPUBLICA ESLOVACA
REUNIÓN
RUMANIA
RUSIA
SENEGAL
SERBIA
SINGAPUR
SUECIA
SUIZA
TAILANDIA
TÚNEZ
TURQUÍA
UCRANIA
URUGUAY

A photograph of a cardboard box in a warehouse. The box is brown and has the 'INDEX' logo printed on it in blue. The logo consists of a stylized 'I' made of three horizontal bars, followed by the word 'INDEX' in a bold, sans-serif font, with a registered trademark symbol (®) to the right. Below the logo, the slogan 'A PERFECT FIXING' is printed in a smaller, blue, sans-serif font. The background is a blurred warehouse interior with a worker in a blue uniform on the left and bright overhead lights.

INDEX[®]
A PERFECT FIXING

CONDICIONES DE VENTA ESPAÑA

PORTES

Los portes serán pagados a partir de 250€ netos para los envíos a la península y Baleares. En este caso, nos reservamos el derecho a remitir las mercancías por nuestra habitual agencia de transportes.

En el caso de que los portes sean debidos y salvo indicación expresa por parte del cliente, las mercancías las enviaremos por nuestra habitual agencia de transportes.

Rogamos procedan a verificar el estado de la mercancía a su recepción y formulen ante el transportista las reservas que en su caso procedan, comunicándonos las posibles objeciones de inmediato.

La recepción de la mercancía, supone la aceptación de las condiciones generales de venta de INDEX A Perfect Fixing.

El importe mínimo de pedido es de 100€. Por cuestiones derivadas de costos y, en el caso de aceptarse un pedido de importe inferior, se cargarán 10€ en concepto de gastos de gestión.

CONDICIONES DE PAGO

Forma de pago: Giro bancario domiciliado a 60 días máximo.

Si las letras no están domiciliadas, INDEX A Perfect Fixing, en ningún caso se hará cargo de los posibles gastos de devolución.

Los documentos de pago, deberán ser remitidos en un plazo máximo de 30 días posteriores a la fecha de la factura.

Los documentos de pago que no respeten los vencimientos reflejados en nuestra factura, ocasionarán un cargo por aplazamiento del 1% mensual.

Nuestro sistema informático retendrá automáticamente los pedidos si se produjese algún impago o demora en la recepción de documentos de pago.

PLAZO DE ENTREGA

Salvo acuerdo expreso por nuestra Central, los plazos de entrega indicados por nuestros representantes son a título orientativo.

El retraso de los plazos de entrega o fechas previstas no dará lugar a penalización.

AGOSTO Y DICIEMBRE

Los vencimientos que se atiendan en estos meses, no tendrán cargos ni abonos. Si el vencimiento se fracciona al 50% entre el mes anterior y posterior, no se aplicarán cargos ni abonos.

Si el vencimiento se adelanta al mes anterior, se abonará en factura un 1% de descuento en concepto de pago adelantado.

Si el vencimiento se aplaza al mes siguiente, se cargará en factura un 1% en concepto de gastos financiero.

DEVOLUCIÓN DE MATERIAL

No se admitirán devoluciones de material transcurridos 15 días desde la fecha de entrega.

Si la devolución se produce por motivos no imputables a INDEX A Perfect Fixing el cliente la enviará a portes pagados. Adicionalmente se le cargará el coste que se origine en concepto de reempaquetado, así como los del transporte del envío inicial. En total el recargo supondrá un 20% aproximado del valor de la mercancía.

El importe de la mercancía devuelta o abono, será descontado de la factura de origen y se le notificará al cliente.

No se admitirán devoluciones de material a portes debidos, si no vienen por nuestras agencias habituales de transporte.

Para cualquier cuestión derivada de la venta efectuada por INDEX A Perfect Fixing (Técnicas Expansivas, S.L.), serán competentes los Juzgados y Tribunales de la ciudad de Logroño. Los precios de esta tarifa, no incluyen el IVA. INDEX A Perfect Fixing se reserva el derecho a cambiar precios, envasados o artículos en stock sin previo aviso.

INDEX A Perfect Fixing, a razón de sus necesidades de producción, se reserva el derecho a modificar sin previo aviso el diseño, las características o prestaciones de sus productos. Las imágenes de este catálogo, son ilustraciones informativas sin ningún valor contractual, pudiendo no coincidir con el modelo original.

Ref.	pag.	Ref.	pag.	Ref.	pag.	Ref.	pag.	Ref.	pag.		
6921108020	212	AACGA10	68	ABAI519042	241	ABDP160	243	ABE186313	143	ABE14216	142
6921108050	212	AACGA12	68	ABAI519054	241	ABDP200	243	ABE186314	143	ABE14219	142
6921108070	212	AACTO06	68	ABAI519060	241	ABDP250	243	ABE186319	143	ABE14813	142
9758ZM05	310	AACTO08	68	ABAI519064	241	ABDZ6012	251	ABE186325	143	ABE14816	142
9758ZM06	310	AACTO10	68	ABAI519067	241	ABDZ6015	251	ABE186332	143	ABE14819	142
9758ZM08	310	AACTO12	68	ABAI519076	241	ABDZ6018	251	ABE186338	143	ABE14825	142
9758ZM10	310	AACTO16	68	ABAI519080	241	ABDZ6022	251	ABE186350	143	ABE14832	142
9758ZM12	310	AB61012	252	ABAI519114	241	ABDZ6028	251	ABE186363	143	ABE15519	142
9758ZM14	310	AB61015	252	ABAI530027	241	ABDZ70810	253	ABE186375	143	ABE15522	142
9758ZM16	310	AB61016	252	ABAI530034	241	ABDZ71012	253	ABE186380	143	ABE15525	142
9758ZM18	310	AB61018	252	ABAI530042	241	ABDZ71214	253	ABE186390	143	ABE16319	142
9758ZM20	310	AB61022	252	ABAI530049	241	ABDZ71416	253	ABE255522	143	ABE16325	142
9758ZM22	310	AB61026	252	ABAI530054	241	ABDZ71618	253	ABE255525	143	ABFC09	316
9758ZM24	310	AB61028	252	ABAI530060	241	ABDZ71820	253	ABE256310	143	ABFC14	316
9758ZM27	310	AB61032	252	ABAI530076	241	ABDZ72022	253	ABE256311	143	ABFC19	316
9758ZM30	310	AB61035	252	ABAI530089	241	ABDZ72224	253	ABE256312	143	ABFP25	316
9758ZM33	310	AB61042	252	ABAI530108	241	ABDZ72628	253	ABE256313	143	ABFP32	316
9758ZM36	310	AB61048	252	ABAI530114	241	ABE144219	143	ABE256314	143	ABGA018	242
975A2M04	310	AB61054	252	ABAI540049	241	ABE144225	143	ABE256325	143	ABGA022	242
975A2M05	310	AB61060	252	ABAI540060	241	ABE144816	143	ABE256332	143	ABGA028	242
975A2M06	310	AB71DZ0810	254	ABAI540089	241	ABE144819	143	ABE256338	143	ABGA035	242
975A2M08	310	AB71DZ1012	254	ABAI540114	241	ABE144819CP	143	ABE256350	143	ABGA040	242
975A2M10	310	AB71DZ1214	254	ABAI540133	241	ABE144825	143	ABE256363	143	ABGA048	242
975A2M12	310	AB71DZ1416	254	ABAI540140	241	ABE144832	143	ABE256380	143	ABGA054	242
975A2M14	310	AB71DZ1618	254	ABAI540159	241	ABE144838	143	ABE256390	143	ABGA060	242
975A2M16	310	AB71DZ1820	254	ABAI540168	241	ABE145522	143	ABE3509	142	ABGA075	242
975A2M18	310	AB71DZ2022	254	ABAI540219	241	ABE145532	143	ABE3513	142	ABGA090	242
975A2M20	310	AB71DZ2224	254	ABBU1315	260	ABE164219	143	ABE3516	142	ABGA100	242
975A2M22	310	AB71DZ2628	254	ABBU1618	260	ABE164816	143	ABE3519	142	ABGA110	242
975A2M24	310	AB71Z010	254	ABBU1921	260	ABE164819	143	ABE4213	142	ABGA115	242
975A2M27	310	AB71Z012	254	ABCH00034	264	ABE164819CP	143	ABE4216	142	ABGA140	242
975A2M30	310	AB71Z014	254	ABCH010000	264	ABE164825	143	ABE4219	142	ABGA160	242
975A2M33	310	AB71Z016	254	ABCH01012	264	ABE164832	143	ABE4225	142	ABGD012	261
975A2M36	310	AB71Z018	254	ABCH01014	264	ABE164838	143	ABE4232	142	ABGD015	261
975ZM04	310	AB71Z020	254	ABCH020000	264	ABE165519	143	ABE4238	142	ABGD018	261
975ZM05	310	AB71Z022	254	ABCH02012	264	ABE165522	143	ABE4813	142	ABGD022	261
975ZM06	310	AB71Z024	254	ABCH030000	264	ABE165522CP	143	ABE4816	142	ABGD028	261
975ZM08	310	AB71Z026	254	ABCH040000	264	ABE165525	143	ABE4819	142	ABGM012	260
975ZM10	310	AB71Z028	254	ABCH050000	264	ABE165532	143	ABE4825	142	ABGM015	260
975ZM12	310	AB71Z032	254	ABCH060000	264	ABE165538	143	ABE4832	142	ABGM018	260
975ZM14	310	AB71Z034	254	ABCH080000	264	ABE165550	143	ABE4838	142	ABGM022	260
975ZM16	310	AB71Z036	254	ABCH100000	264	ABE165563	143	ABE5519	142	ABGM028	260
975ZM18	310	AB71Z038	254	ABCH120000	264	ABE165575	143	ABE5522	142	ABGM035	260
975ZM20	310	AB71Z040	254	ABCH140000	264	ABE166310	143	ABE5525	142	ABGS010	261
975ZM22	310	AB71Z050	254	ABCH160000	264	ABE166311	143	ABE5532	142	ABGS012	261
975ZM24	310	ABA4832	154	ABCIKIT30	265	ABE166312	143	ABE5538	142	ABGS015	261
975ZM27	310	ABA4838	154	ABCR010	259	ABE166313	143	ABE5550	142	ABGS018	261
975ZM2M06	311	ABA4845	154	ABCR012	259	ABE166314	143	ABE5563	142	ABGS022	261
975ZM30	310	ABA4850	154	ABD6012	251	ABE166319	143	ABE5575	142	ABGS028	261
975ZM33	310	ABA5538	154	ABD6015	251	ABE166325	143	ABE6310	142	ABGS035	261
975ZM36	310	ABA5545	154	ABD6018	251	ABE166325CP	143	ABE6311	142	ABGS042	261
AACAR06	68	ABA5555	154	ABD6022	251	ABE166332	143	ABE6312	142	ABGS054	261
AACAR08	68	ABA5565	154	ABD6028	251	ABE166338	143	ABE6313	142	ABGUG15	277
AACAR10	68	ABA6360	154	ABDE075	243	ABE166350	143	ABE6314	142	ABGUG18	277
AACAR12	68	ABA6370	154	ABDE090	243	ABE166363	143	ABE6315	142	ABGUG20	277
AACCA06	68	ABA6385	154	ABDE110	243	ABE166375	143	ABE6316	142	ABGUG22	277
AACCA08	68	ABAI53010	241	ABDE125	243	ABE166380	143	ABE6318	142	ABGUG25	277
AACCA10	68	ABAI53012	241	ABDE160	243	ABE166390	143	ABE6319	142	ABGUG28	277
AACCA12	68	ABAI53015	241	ABDE200	243	ABE184819	143	ABE6320	142	ABGUG32	277
AACCA16	68	ABAI53018	241	ABDE250	243	ABE184825	143	ABE6322	142	ABGUG40	277
AACCI06	68	ABAI53022	241	ABDE315	243	ABE184838	143	ABE6324	142	ABGUG50	277
AACCI08	68	ABAI53028	241	ABDI0012	252	ABE185522	143	ABE6325	142	ABGX4121	294
AACCI10	68	ABAI519010	241	ABDI0015	252	ABE185525	143	ABE6332	142	ABIA015	235
AACCI12	68	ABAI519012	241	ABDI0018	252	ABE185532	143	ABE6338	142	ABIA018	235
AACES06	68	ABAI519015	241	ABDI0022	252	ABE185538	143	ABE6350	142	ABIA022	235
AACES08	68	ABAI519017	241	ABDI0028	252	ABE185550	143	ABE6363	142	ABIA028	235
AACES10	68	ABAI519018	241	ABDP075	243	ABE185563	143	ABE6375	142	ABIA035	235
AACES12	68	ABAI519022	241	ABDP090	243	ABE186310	143	ABE6380	142	ABIA042	235
AACGA06	68	ABAI519028	241	ABDP110	243	ABE186311	143	ABE6390	142	ABIA048	235
AACGA08	68	ABAI519035	241	ABDP125	243	ABE186312	143	ABE14213	142	ABIA054	235

Ref.	pag.	Ref.	pag.	Ref.	pag.	Ref.	pag.	Ref.	pag.	Ref.	pag.
ABIA060	235	ABM6032	250	ABMZ6054	250	ABPI012	255	ABR3932	150	ABRC3919	152
ABIA075	235	ABM6035	250	ABMZ6060	250	ABPI014	255	ABR4213	150	ABRC3925	152
ABIA090	235	ABM6037	250	ABMZ6063	250	ABPI016	255	ABR4213BLE	151	ABRC3938	152
ABIAI00	235	ABM6040	250	ABMZ7008	253	ABPI018	255	ABR4216	150	ABRC4213	152
ABIAI10	235	ABM6042	250	ABMZ7010	253	ABPI020	255	ABR4216BLE	151	ABRC4216	152
ABIAI15	235	ABM6047	250	ABMZ7012	253	ABPI022	255	ABR4219	150	ABRC4219	152
ABIAI25	235	ABM6050	250	ABMZ7014	253	ABPI025	255	ABR4219BLE	151	ABRC4225	152
ABICP060	240	ABM6054	250	ABMZ7016	253	ABPI026	255	ABR4222	150	ABRC4232	152
ABICP075	240	ABM6060	250	ABMZ7018	253	ABPI028	255	ABR4225	150	ABRC4238	152
ABICP090	240	ABM6063	250	ABMZ7020	253	ABPI032	255	ABR4232	150	ABRC4810	152
ABICP110	240	ABM6A2012	251	ABMZ7022	253	ABPI040	255	ABR4238	150	ABRC4816	152
ABICP140	240	ABM6A2015	251	ABMZ7024	253	ABPI042	255	ABR4250	150	ABRC4819	152
ABICP160	240	ABM6A2018	251	ABMZ7025	253	ABPI047	255	ABR4810	150	ABRC4825	152
ABICP220	240	ABM6A2020	251	ABMZ7026	253	ABPI050	255	ABR4811	150	ABRC4832	152
ABICP270	240	ABM6A2022	251	ABMZ7028	253	ABPI063	255	ABR4812	150	ABRC4838	152
ABICP315	240	ABM6A2028	251	ABMZ7032	253	ABPID016	138	ABR4813	150	ABRC4845	152
ABID012	276	ABM8050	242	ABMZ7034	253	ABPID020	138	ABR4816	150	ABRC4850	152
ABID014	276	ABM8063	242	ABMZ7036	253	ABPID025	138	ABR4819	150	ABRC4860	152
ABID016	276	ABM8075	242	ABMZ7038	253	ABPID032	138	ABR4822	150	ABRC4880	152
ABID020	276	ABM8090	242	ABMZ7040	253	ABPM720	314	ABR4825	150	ABRC4890	152
ABID028	276	ABM8110	242	ABMZ7050	253	ABPM730	314	ABR4825BLE	151	ABRC5525	152
ABIN012	276	ABM8125	242	ABMZ7063	253	ABPM740	314	ABR4832	150	ABRC5573	152
ABIN014	276	ABM8160	242	ABP3509	153	ABPRC12	278	ABR4838	150	ABRE018	236
ABIN016	276	ABM8200	242	ABP3511	153	ABPRC15	278	ABR4845	150	ABRE022	236
ABIN020	276	ABM8250	242	ABP3513	153	ABPRC20	278	ABR4850	150	ABRE028	236
ABIN025	276	ABM8315	242	ABP3516	153	ABPRC25	278	ABR4860	150	ABRE035	236
ABIN028	276	ABMD10	278	ABP3519	153	ABPRC32	278	ABR4880	150	ABRE040	236
ABIN032	276	ABMD12	278	ABP3522	153	ABPRC40	278	ABR4890	150	ABRE048	236
ABIN035	276	ABMD14	278	ABP3525	153	ABPRC50	278	ABR5519	150	ABRE054	236
ABIP015	256	ABMD16	278	ABP3913	153	ABPT3513	154	ABR5522	150	ABRE060	236
ABIP018	256	ABMD18	278	ABP3916	153	ABPT3516	154	ABR5525	150	ABRE070	236
ABIP022	256	ABMD20	278	ABP3919	153	ABPT3519	154	ABR5532	150	ABRE075	236
ABIP026	256	ABMD22	278	ABP3922	153	ABPT3913	154	ABR5538	150	ABRE083	236
ABIP028	256	ABMD26	278	ABP3925	153	ABPT3916	154	ABR5545	150	ABRE090	236
ABIP035	256	ABMD28	278	ABP3932	153	ABPT4213	154	ABR5560	150	ABRE090	236
ABIP042	256	ABMS10	278	ABP3938	153	ABPT4216	154	ABR5573	150	ABRE100	236
ABIP048	256	ABMS12	278	ABP4213	153	ABPT4219	154	ABR5573	150	ABRE110	236
ABIP054	256	ABMS14	278	ABP4216	153	ABPT4225	154	ABRA015	234	ABRE115	236
ABIP060	256	ABMS16	278	ABP4219	153	ABPT4232	154	ABRA018	234	ABRE125	236
ABIP067	256	ABMS18	278	ABP4222	153	ABPT4232	154	ABRA022	234	ABRE133	236
ABIP075	256	ABMS20	278	ABP4225	153	ABPT4819	154	ABRA028	234	ABRE140	236
ABIP090	256	ABMS22	278	ABP4232	153	ABPT4825	154	ABRA035	234	ABRE150	236
ABIR015	235	ABMS26	278	ABP4238	153	ABPT4832	154	ABRA042	234	ABRE160	236
ABIR018	235	ABMS28	278	ABP4813	153	ABPT4838	154	ABRA048	234	ABRE180	236
ABIR022	235	ABMUG15	277	ABP4816	153	ABPT4850	154	ABRA054	234	ABRE200	236
ABIR028	235	ABMUG18	277	ABP4819	153	ABPU016	255	ABRA060	234	ABRE220	236
ABIR035	235	ABMUG22	277	ABP4825	153	ABPU018	255	ABRA075	234	ABRE250	236
ABIR040	235	ABMUG26	277	ABP4832	153	ABPU020	255	ABRA090	234	ABRE280	236
ABIR048	235	ABMUG32	277	ABP4838	153	ABPU022	255	ABRA100	234	ABRE300	236
ABIR054	235	ABMUG40	277	ABP4838	153	ABPU025	255	ABRA110	234	ABRE315	236
ABIR060	235	ABMUG48	277	ABP4850	153	ABPU028	255	ABRA115	234	ABRE355	236
ABITD015	259	ABMZ6008	250	ABP5519	153	ABPU032	255	ABRA125	234	ABRE400	236
ABITD018	259	ABMZ6010	250	ABP5525	153	ABPU037	255	ABRA23509	151	ABRE450	236
ABITD022	259	ABMZ6012	250	ABP5532	153	ABPU040	255	ABRA23513	151	ABRE500	236
ABITS015	259	ABMZ6014	250	ABP5538	153	ABPU050	255	ABRA23519	151	ABRE560	236
ABITS018	259	ABMZ6015	250	ABP5550	153	ABPU063	255	ABRA24213	151	ABRE600	236
ABITS022	259	ABMZ6016	250	ABPE028	264	ABR3509	150	ABRA24216	151	ABRE630	236
ABITS028	259	ABMZ6018	250	ABPE035	264	ABR3509BLE	151	ABRA24219	151	ABRE710	236
ABM6008	250	ABMZ6020	250	ABPE040	264	ABR3511	150	ABRA24225	151	ABRE800	236
ABM6010	250	ABMZ6022	250	ABPE048	264	ABR3513	150	ABRA24816	151	ABRE900	236
ABM6012	250	ABMZ6025	250	ABPE060	264	ABR3513BLE	151	ABRA24819	151	ABRE910	236
ABM6014	250	ABMZ6026	250	ABPE075	264	ABR3516	150	ABRA24825	151	ABRE911	236
ABM6015	250	ABMZ6028	250	ABPE090	264	ABR3516BLE	151	ABRA24832	151	ABRE912	236
ABM6016	250	ABMZ6032	250	ABPE100	264	ABR3519	150	ABRA24838	151	ABREA2018	237
ABM6018	250	ABMZ6035	250	ABPETI5	264	ABR3522	150	ABRA24850	151	ABREA2022	237
ABM6020	250	ABMZ6037	250	ABPE140	264	ABR3525	150	ABRC3509	152	ABREA2028	237
ABM6022	250	ABMZ6040	250	ABPE160	264	ABR3532	150	ABRC3513	152	ABREA2035	237
ABM6025	250	ABMZ6042	250	ABPE220	264	ABR3913	150	ABRC3516	152	ABREA2040	237
ABM6026	250	ABMZ6047	250	ABPI006	255	ABR3916	150	ABRC3519	152	ABREA2048	237
ABM6028	250	ABMZ6050	250	ABPI008	255	ABR3919	150	ABRC3913	152	ABREA2054	237
				ABPI010	255	ABR3925	150	ABRC3916	152	ABREA2060	237

Ref.	pag.	Ref.	pag.	Ref.	pag.	Ref.	pag.	Ref.	pag.	Ref.	pag.
ABREA2075	237	ABRIA2054	239	ABRT5560	152	ABTR05040	314	ACHTI4C	57	AFRTI44819	183
ABREA2090	237	ABRIA2060	239	ABRT5573	152	ABTR05050	314	ACHTI4L	57	AFRTI44828	183
ABREA2110	237	ABRIA2075	239	ABSA050100	245	ABTR05060	314	ACHTI6C	57	AFRTI44835	183
ABREA2115	237	ABRIA2090	239	ABSA050125	245	ABTR06040	314	ACHTI6L	57	AFVEI44819	184
ABREA2125	237	ABRIA2110	239	ABSA050200	245	ABTR06050	314	ACHT20C	57	AFVEI44828	184
ABREA2140	237	ABRIA2115	239	ABSA050300	245	ABTR06060	314	ACHT25C	57	AFVEI44835	184
ABREA2160	237	ABRIA2125	239	ABSA050400	245	ABTS014	279	ACHT8808C	58	AFZNI44819	183
ABREA2200	237	ABRIA2140	239	ABSA050500	245	ABTS016	279	ACHT8808E	58	AFZNI44828	183
ABREA4018	237	ABRIA2160	239	ABSA050600	245	ABTS018	279	ACHT8808L	58	AFZNI44835	183
ABREA4022	237	ABRIA4018	239	ABSA100100	245	ABTS020	279	ACHT8810C	58	AGP023025	245
ABREA4028	237	ABRIA4022	239	ABSA100125	245	ABTS022	279	ACHT8810E	58	AGP026028	245
ABREA4035	237	ABRIA4028	239	ABSA100200	245	ABTS025	279	ACHT8810L	58	AGP029031	245
ABREA4040	237	ABRIA4035	239	ABSA100300	245	ABTS028	279	ACHT8812C	58	AGP032035	245
ABREA4048	237	ABRIA4040	239	ABSA100400	245	ABTS032	279	ACHT8812L	58	AGP036039	245
ABREA4054	237	ABRIA4048	239	ABSA100500	245	ACHA08C	61	ACHT8816C	58	AGP040043	245
ABREA4060	237	ABRIA4054	239	ABSI003	256	ACHA09C	61	ACHT8816L	58	AGP044047	245
ABREA4075	237	ABRIA4060	239	ABSI004	256	ACHA10C	61	ACHT8820C	58	AGP048051	245
ABREA4090	237	ABRIA4075	239	ABSI005	256	ACHA11C	61	ACHTA208C	57	AGP052055	245
ABREA4110	237	ABRIA4090	239	ABSI006	256	ACHA12C	61	ACHTA208L	57	AGP056059	245
ABREA4115	237	ABRIA4110	239	ABSI007	256	ACHA14C	61	ACHTA209C	57	AGP060063	245
ABREA4125	237	ABRIA4115	239	ABSI008	256	ACHA16C	61	ACHTA209L	57	AGP064067	245
ABREA4140	237	ABRIA4125	239	ABSI009	256	ACHAA208C	61	ACHTA210C	57	AGP068073	245
ABREA4160	237	ABRIA4140	239	ABSI010	256	ACHAA210C	61	ACHTA210L	57	AGP074079	245
ABREA4200	237	ABRIA4160	239	ABSI011	256	ACHAA212C	61	ACHTA211C	57	AGP080085	245
ABRI018	238	ABRID016	240	ABSI012	256	ACHAFO08C	61	ACHTA211L	57	AGP086091	245
ABRI022	238	ABRID020	240	ABSI013	256	ACHAFO10C	61	ACHTA212C	57	AGP092097	245
ABRI028	238	ABRID025	240	ABSI014	256	ACHAFO12C	61	ACHTA212L	57	AGP098103	245
ABRI035	238	ABRID032	240	ABSI015	256	ACHE08C	59	ACHTA214C	57	AGP104712	245
ABRI040	238	ABRID040	240	ABSI016	256	ACHE09C	59	ACHTA214L	57	AGP113121	245
ABRI048	238	ABRID050	240	ABSI017	256	ACHE10C	59	ACHTA216C	57	AGP122130	245
ABRI054	238	ABRID063	240	ABSI018	256	ACHE10L	59	ACHTA216L	57	AGP131139	245
ABRI060	238	ABRID075	240	ABSI019	256	ACHE11C	59	ACHTA220C	57	AGP140148	245
ABRI070	238	ABRID090	240	ABSI020	256	ACHE11L	59	ACHTPI08C	58	AGP149161	245
ABRI075	238	ABRID110	240	ABSI021	256	ACHE12C	59	ACHTPI08L	58	AGP162174	245
ABRI083	238	ABRID125	240	ABSI022	256	ACHE12L	59	ACHTPI10C	58	AH06060	43
ABRI090	238	ABRID140	240	ABSI025	256	ACHE14C	59	ACHTPI10L	58	AH06070	43
ABRI100	238	ABRID160	240	ABTA0630	313	ACHE14L	59	ACHTPI12C	58	AH06080	43
ABRI110	238	ABRT3509	152	ABTA0640	313	ACHG08C	60	ACHTPI12L	58	AH06090	43
ABRI115	238	ABRT3513	152	ABTA0650	313	ACHG09C	60	ACHTPL08C	58	AH06100	43
ABRI125	238	ABRT3516	152	ABTA0730	313	ACHG10C	60	ACHTPL08L	58	AH06110	43
ABRI133	238	ABRT3519	152	ABTA0740	313	ACHG11C	60	ACHTPL10C	58	AH06120	43
ABRI140	238	ABRT3913	152	ABTA0750	313	ACHG12C	60	ACHTPL10L	58	AH06130	43
ABRI150	238	ABRT3916	152	ABTA0760	313	ACHG14C	60	ACHTPL12C	58	AH06140	43
ABRI160	238	ABRT3919	152	ABTA0770	313	ACHG16C	60	ACHTPL12L	58	AH06150	43
ABRI180	238	ABRT3925	152	ABTA0780	313	ACHGA208C	60	ADUTC47	128	AH06160	43
ABRI200	238	ABRT4213	152	ABTA0840	313	ACHGA210C	60	ADUTC60	128	AH06170	43
ABRI220	238	ABRT4216	152	ABTA0860	313	ACHGA212C	60	AFAZI44819	184	AH06180	43
ABRI250	238	ABRT4219	152	ABTA0880	313	ACHGE10	60	AFAZI44828	184	AH08060	43
ABRI280	238	ABRT4225	152	ABTA1050	313	ACHGE12	60	AFAZI44835	184	AH08075	43
ABRI300	238	ABRT4232	152	ABTA1070	313	ACHGFO08C	60	AFBLI44819	185	AH08090	43
ABRI315	238	ABRT4238	152	ABTA1090	313	ACHGFO10C	60	AFBLI44828	185	AH08100	43
ABRI355	238	ABRT4250	152	ABTA20630	314	ACHGFO12C	60	AFBLI44835	185	AH08115	43
ABRI400	238	ABRT4810	152	ABTAB0630	313	ACHINB08C	59	AFGRI44819	185	AH08120	43
ABRI450	238	ABRT4811	152	ABTAB0640	313	ACHINB08L	59	AFGRI44828	185	AH08130	43
ABRI500	238	ABRT4812	152	ABTAB0650	313	ACHINB10C	59	AFGRI44835	185	AH08155	43
ABRI560	238	ABRT4813	152	ABTC020	279	ACHINB10L	59	AFMCI44819	184	AH10070	43
ABRI600	238	ABRT4816	152	ABTC025	279	ACHINN08C	59	AFMCI44828	184	AH10080	43
ABRI630	238	ABRT4819	152	ABTD016	279	ACHINN08L	59	AFMCI44835	184	AH10090	43
ABRI710	238	ABRT4825	152	ABTD018	279	ACHINN10C	59	AFMDI44819	184	AH10100	43
ABRI800	238	ABRT4832	152	ABTD020	279	ACHINN10L	59	AFMDI44828	184	AH10120	43
ABRI900	238	ABRT4838	152	ABTD022	279	ACHT08C	57	AFMDI44835	184	AH10140	43
ABRI910	238	ABRT4845	152	ABTD025	279	ACHT08L	57	AFNEI44819	185	AH10150	43
ABRI911	238	ABRT4850	152	ABTD028	279	ACHT09C	57	AFNEI44828	185	AH10160	43
ABRI912	238	ABRT4860	152	ABTG4530	314	ACHT09L	57	AFNEI44835	185	AH10170	43
ABRIA2018	239	ABRT4880	152	ABTG4535	314	ACHT10C	57	AFPGI44819	184	AH10210	43
ABRIA2022	239	ABRT4890	152	ABTG4540	314	ACHT10L	57	AFPGI44828	184	AH10230	43
ABRIA2028	239	ABRT5519	152	ABTG5030	314	ACHT11C	57	AFPGI44835	184	AH12090	43
ABRIA2035	239	ABRT5525	152	ABTG5040	314	ACHT11L	57	AFRDI44819	183	AH12100	43
ABRIA2040	239	ABRT5532	152	ABTO06015	256	ACHT12C	57	AFRDI44828	183	AH12110	43
ABRIA2048	239	ABRT5538	152	ABTR05030	314	ACHT12L	57	AFRDI44835	183	AH12120	43

Ref.	pag.	Ref.	pag.	Ref.	pag.	Ref.	pag.	Ref.	pag.	Ref.	pag.
AH12130	43	AISS10070	102	ALRO14025	189	AM14080	46	APA410105	41	APX10105	42
AH12140	43	AISS10090	102	ALRO16030	189	AM14100	46	APA410115	41	APX10115	42
AH12160	43	AISS10100	102	ALRO17040	189	AM14120	46	APA410135	41	APX10135	42
AH12180	43	AISS10120	102	ALRO18040	189	AM14145	46	APA410165	41	APX10165	42
AH12200	43	AISS10140	102	ALRO18050	189	AM14170	46	APA410185	41	APX10185	42
AH12220	43	AISS10160	102	ALRO19050	189	AM14220	46	APA412110	41	APX12080	42
AH12250	43	AISS10180	102	ALRO19060	189	AM14250	46	APA412120	41	APX12100	42
AH14120	43	AISS10200	102	ALRO19070	189	AM16090	46	APA412130	41	APX12110	42
AH14145	43	AISS10220	102	ALRO20060	189	AM16110	46	APA412150	41	APX12120	42
AH14170	43	AISS10260	102	ALRO20070	189	AM16125	46	APA412180	41	APX12130	42
AH14220	43	AISW060	103	ALRO20080	189	AM16145	46	APA412200	41	APX12150	42
AH14250	43	ALHA14025	191	ALRO21080	189	AM16170	46	APA416125	41	APX12180	42
AH16125	43	ALHA16030	191	ALRO21090	189	AM16220	46	APA416145	41	APX12200	42
AH16145	43	ALHA17040	191	ALRO22100	189	AM16250	46	APA416175	41	APX12220	42
AH16170	43	ALHA18040	191	ALRO22110	189	AM16280	46	APA416190	41	APX12255	42
AH16220	43	ALHA18050	191	ALRO22120	189	AM20120	47	APA416220	41	APX16145	42
AH16250	43	ALHA19050	191	ALRO23130	189	AM20170	47	APA420200	41	APX16175	42
AH16280	43	ALHA19060	191	ALROBI6030	189	AM20220	47	APA420240	41	APX16220	42
AH20170	43	ALHA19070	191	ALROBI7040	189	AM20270	47	APA420285	41	APX16250	42
AH20220	43	ALHA20050	191	ALROBI8050	189	AM24180	47	APAR070	205	APX20170	42
AH20270	43	ALHA20060	191	ALROBI9060	189	AM24260	47	APAR150	205	APX20200	42
AHIAR0645	69	ALHA20070	191	AM06045	46	ANCLA40	110	APAT071	205	ARANE14	148
AHIAR0855	69	ALHA20080	191	AM06055	46	ANCLA47	110	APAT091	205	ARANE16	148
AHIAR1065	69	ALHA21070	191	AM06060	46	ANCU06040	65	APATI01	205	ARANE18	148
AHIAR1275	69	ALHA21080	191	AM06065	46	ANCU06070	65	APEN71	206	ARANE25	148
AHIAR1690	69	ALHA21090	191	AM06070	46	ANFA2309	71	APEN91	206	ARE164816	146
AHICA0645	69	ALHA21100	191	AM06080	46	ANFA2312	71	APFL801020	205	ARE164819	146
AHICA0855	69	ALHA22110	191	AM06085	46	ANFA2316	71	APFUZ100	205	ARE165522	146
AHICA1065	69	ALHA22120	191	AM06090	46	ANFA2319	71	APG06060	42	ARE166320	146
AHICA1275	69	ALHA23130	191	AM06100	46	ANFA2323	71	APG06070	42	ARE166325	146
AHICA1690	69	ALHAB16030	191	AM06110	46	ANFA2330	71	APG06100	42	ARE166332	146
AHICI0645	69	ALHAB17040	191	AM06120	46	ANFA2335	71	APG08050	42	ARE166338	146
AHICI0855	69	ALHAB18050	191	AM06130	46	ANFA5114	71	APG08060	42	ARE166350	146
AHICI1065	69	ALHAB19060	191	AM06140	46	ANFA5116	71	APG08075	42	ARE4816	145
AHIGA0645	69	ALHCA14025	190	AM06150	46	ANFA5120	71	APG08095	42	ARE4819	145
AHIGA0855	69	ALHCA16030	190	AM06160	46	ANFA5124	71	APG08115	42	ARE5522	145
AHIGA1065	69	ALHCA17040	190	AM06170	46	ANFATA37B	71	APG10070	42	ARE6320	145
AHIGA1275	69	ALHCA18040	190	AM06180	46	ANFATA70B	71	APG10090	42	ARE6325	145
AHIGA1690	69	ALHCA18050	190	AM08050	46	ANFAZ5021	71	APG10105	42	ARE6332	145
AHITO0645	69	ALHCA19050	190	AM08060	46	AP08050	41	APG10115	42	ARE6338	145
AHITO0855	69	ALHCA19060	190	AM08065	46	AP08075	41	APG10135	42	ARE6350	145
AHITO1065	69	ALHCA19070	190	AM08075	46	AP08095	41	APG10165	42	ARE6363	145
AHITO1275	69	ALHC20050	190	AM08090	46	AP08115	41	APG10185	42	ARE6380	145
AHITO1690	69	ALHC20060	190	AM08115	46	API0090	41	APG12080	42	ARFOM06Z	312
AIS08080	102	ALHC20070	190	AM08120	46	API0105	41	APG12110	42	ARFOM08Z	312
AIS08100	102	ALHC20080	190	AM08130	46	API0115	41	APG12130	42	ARFOM10Z	312
AIS08120	102	ALHC21070	190	AM08155	46	API0135	41	APG12150	42	ARFOM12Z	312
AIS08140	102	ALHC21080	190	AM10065	46	API0165	41	APG12180	42	ARFOM16Z	312
AISAM085	103	ALHC21090	190	AM10070	46	API0185	41	APG12200	42	ARINO14	148
AISC10070	102	ALHC21100	190	AM10080	46	API2080	41	APG16125	42	ARINO16	148
AISC10090	102	ALHC22110	190	AM10090	46	API2100	41	APG16145	42	ARINO18	148
AISC10100	102	ALHC22120	190	AM10100	46	API2110	41	APG16175	42	ARINO25	148
AISC10110	102	ALHC23130	190	AM10120	46	API2120	41	APG16220	42	ARINOM30	148
AISC10120	102	ALHCB16030	190	AM10140	46	API2130	41	APG20170	42	ARSP08	302
AISC10130	102	ALHCB17040	190	AM10150	46	API2150	41	APG20200	42	ARSP10	302
AISC10140	102	ALHCB18050	190	AM10160	46	API2180	41	APPD100	205	ARSS10	302
AISC10160	102	ALHCB19060	190	AM10170	46	API2200	41	APPG070	206	ARSS12	302
AISC10180	102	ALPL45060	188	AM10210	46	API6145	41	APPG100	206	ASF008016	257
AISC10200	102	ALPL45080	188	AM10230	46	API6175	41	APPT071	206	ASF012022	257
AISC10220	102	ALPL45100	188	AM12075	46	API6220	41	APPT091	206	ASF016027	257
AISC10260	102	ALPL50120	188	AM12080	46	API6250	41	APPT101	206	ASF020032	257
AISM08090	103	ALRE20015	188	AM12090	46	AP20170	41	APSB71	206	ASF025040	257
AISM08110	103	ALRE25020	188	AM12100	46	AP20200	41	APSB91	206	ASF030045	257
AISM08120	103	ALRE25025	188	AM12110	46	AP24205	41	APUEZ200	206	ASF035050	257
AISM08140	103	ALRE25030	188	AM12120	46	AP24235	41	APX08050	42	ASF040060	257
AISM08170	103	ALRE35040	188	AM12140	46	APA408075	41	APX08075	42	ASF050070	257
AISM08200	103	ALRE35050	188	AM12160	46	APA408095	41	APX08080	42	ASF060080	257
AISM08250	103	ALRE40060	188	AM12180	46	APA408115	41	APX08095	42	ASF070090	257
AISM08300	103	ALRE40070	188	AM12220	46	APA408135	41	APX08115	42	ASF080100	257
AISR140	102	ALRE40080	188	AM12250	46	APA410090	41	APX10090	42	ASF090110	257

Ref.	pag.	Ref.	pag.	Ref.	pag.	Ref.	pag.	Ref.	pag.	Ref.	pag.
ASF100120	257	AUE256325	146	AZIM060250	244	BBANA19	274	BIE5538	144	BZ158708	220
ASF10130	257	AUE6310	146	AZIM060375	244	BBANA27	274	BIE5550	144	BZ158710	220
ASF120140	257	AUE6311	146	AZIM060500	244	BBANE19	274	BIE5558	144	BZ158712	220
ASF130150	257	AUE6312	146	AZIM060750	244	BBANE27	274	BIE5565	144	BZ3104010	210
ASF2010016	257	AUE6313	146	AZIM061000	244	BC25100AM	275	BIE5580	144	BZ3104016	210
ASF2012020	257	AUE6314	146	AZIM061250	244	BC25100AZ	275	BIE6325	144	BZ3104020	210
ASF2016027	257	AUE6315	146	AZIM081500	244	BC25100GR	273	BN12100	271	BZ3104030	210
ASF2020032	257	AUE6319	146	AZIM082000	244	BC25100MA	275	BN12225	271	BZ3104040	210
ASF2025040	257	AUE6325	146	AZIM082250	244	BC25100RO	275	BN12500	271	BZ3105010	210
ASF2032050	257	AUE6332	146	AZIM082500	244	BC25100VE	274	BN12720	271	BZ3105016	210
ASF2040060	257	AUE6340	146	AZIM083000	244	BC36140AM	275	BN12850	271	BZ3105020	210
ASF2050070	257	AUE6350	146	AZIM083500	244	BC36140AZ	275	BN25080	271	BZ3105025	210
ASF2060080	257	AUE6360	146	AZIM084000	244	BC36140GR	273	BN25100	271	BZ3105030	210
ASF2070090	257	AUE6380	146	AZIM084500	244	BC36140MA	275	BN25140	271	BZ3105040	210
ASF2080100	257	AUTO16532	144	AZIM085000	244	BC36140RO	275	BN25160	271	BZ3105050	210
ASF2090110	257	AUTO16538	144	AZIM086000	244	BC36140VE	274	BN25200	271	BZ3106016	210
ASF2100120	257	AUTO532	144	AZIM103000	244	BC36200AM	275	BN36140	271	BZ3106020	210
ASF2110130	257	AUTO538	144	AZIM103500	244	BC36200AZ	275	BN36200	271	BZ3106025	210
ASF2120140	257	AVC08120	70	AZIM104000	244	BC36200GR	273	BN36250	271	BZ3106030	210
ASF2130150	257	AVC08150	70	AZIM105000	244	BC36200MA	275	BN36300	271	BZ3106040	210
ASFIR03	258	AVC10120	70	AZIM106000	244	BC36200RO	275	BN36370	271	BZ3106050	210
ASFIR30	258	AVC10150	70	AZIM108000	244	BC36200VE	274	BN48120	271	BZ3108016	210
ASFIRCA	258	AVC10180	70	BAESM04	106	BC48200AM	275	BN48160	271	BZ3108020	210
ATA4832	154	AVR08120	70	BAESM05	106	BC48200AZ	275	BN48180	271	BZ3108025	210
ATA4838	154	AVR08150	70	BAESM06	106	BC48200GR	273	BN48200	271	BZ3108030	210
ATA4845	154	AVR10120	70	BAESM08	106	BC48200MA	275	BN48250	271	BZ3108040	210
ATA4850	154	AVR10150	70	BAGAM04	106	BC48200RO	275	BN48290	271	BZ3108050	210
ATA5538	154	AVR10180	70	BAGAM05	106	BC48200VE	274	BN48370	271	BZ3108060	210
ATA5545	154	AZA2060500	244	BAGAM06	106	BC48290AM	275	BN48430	271	BZ3110020	210
ATA5550	154	AZA2060750	244	BAGAM08	106	BC48290AZ	275	BN76150	271	BZ3110030	210
ATA5555	154	AZA2061000	244	BAUTO165510	145	BC48290GR	273	BN76200	271	BZ3110040	210
ATA5565	154	AZA2061250	244	BAUTO165540	145	BC48290MA	275	BN76290	271	BZ3204008	209
ATA6310	154	AZA2081500	244	BAUTO165550	145	BC48290RO	275	BN76370	271	BZ3204010	209
ATA6350	154	AZA2082000	244	BAUTO165565	145	BC48290VE	274	BN76450	271	BZ3204012	209
ATA6360	154	AZA2082500	244	BAUTO165580	145	BCPA24214	155	BN76540	271	BZ3204016	209
ATA6370	154	AZA2083000	244	BAUTO165580	145	BCPA24223	155	BN88770	271	BZ3204020	209
ATA6385	154	AZA2104000	244	BAUTO165580	145	BPCB4214	155	BNDT25100	273	BZ3204025	209
ATAPO08BAR	148	AZA2106000	244	BAUTO165580	145	BPCB4223	155	BNDT36150	273	BZ3204030	209
ATAPO08BO	148	AZA2108000	244	BAUTO165580	145	BPCN4214	155	BNDT36200	273	BZ3204035	209
ATAPO08BP	148	AZAMA06	67	BAUTO165580	145	BPCN4223	155	BNDT48200	273	BZ3204040	209
ATAPO08BNE	148	AZAMA08	67	BB12100	272	BCPZ4214	155	BNDT48300	273	BZ3204045	209
ATAPO08RC	148	AZAMA10	67	BB12225	272	BCPZ4214BL	155	BNDT48370	273	BZ3204050	209
ATAPO08RT	148	AZAMA12	67	BB12500	272	BCPZ4223	155	BNDT76370	273	BZ3204060	209
ATAPO08VN	148	AZAMAF006	67	BB12720	272	BCPZ4223BL	155	BOCA006	228	BZ3205010	209
ATAPO10AR	148	AZAMAF008	67	BB12850	272	BHDS06110	226	BOCA007	228	BZ3205012	209
ATAPO10BO	148	AZAMAF010	67	BB25080	272	BHDS06160	226	BOCA008	228	BZ3205015	209
ATAPO10BP	148	AZAMAF012	67	BB25100	272	BHDS06210	226	BOCA010	228	BZ3205016	209
ATAPO10NE	148	AZAMC06	66	BB25140	272	BHDS08110	226	BPLO2616	274	BZ3205020	209
ATAPO10RC	148	AZAMC08	66	BB25160	272	BHDS08160	226	BZ125IM04	221	BZ3205025	209
ATAPO10RT	148	AZAMC10	66	BB25200	272	BHDS08210	226	BZ125IM05	221	BZ3205030	209
ATAPO10VN	148	AZAMC12	66	BB36140	272	BHDS10160	226	BZ125IM06	221	BZ3205035	209
AUE166319	146	AZAMC16	66	BB36200	272	BHDS10210	226	BZ125IM08	221	BZ3205040	209
AUE166325	146	AZAME06	67	BB36250	272	BHDS12160	226	BZ125IM10	221	BZ3205045	209
AUE166332	146	AZAME08	67	BB36300	272	BHDS12210	226	BZ125ZM03	221	BZ3205050	209
AUE166340	146	AZAME10	67	BB36370	272	BHDS16210	226	BZ125ZM04	221	BZ3205060	209
AUE166350	146	AZAME12	67	BB48120	272	BHDS16310	226	BZ125ZM05	221	BZ3206016	209
AUE166360	146	AZAME16	67	BB48160	272	BID25110	274	BZ125ZM06	221	BZ3206020	209
AUE166380	146	AZAMG06	67	BB48180	272	BID25210	274	BZ125ZM08	221	BZ3206025	209
AUE186310	146	AZAMG08	67	BB48200	272	BIE164825	144	BZ125ZM10	221	BZ3206030	209
AUE186311	146	AZAMG10	67	BB48250	272	BIE165525	144	BZ125ZM12	221	BZ3206040	209
AUE186312	146	AZAMG12	67	BB48290	272	BIE165532	144	BZ12703	223	BZ3206050	209
AUE186313	146	AZAMGFO06	67	BB48370	272	BIE165538	144	BZ12704	223	BZ3206060	209
AUE186314	146	AZAMGFO08	67	BB48430	272	BIE165550	144	BZ12705	223	BZ3206070	209
AUE186315	146	AZAMGFO10	67	BB76150	272	BIE165558	144	BZ12706	223	BZ3208016	209
AUE186325	146	AZAMGFO12	67	BB76200	272	BIE165565	144	BZ12708	223	BZ3208020	209
AUE186332	146	AZAMT06	66	BB76290	272	BIE165580	144	BZ12710	223	BZ3208025	209
AUE186340	146	AZAMT08	66	BB76370	272	BIE166325	144	BZ12712	223	BZ3208030	209
AUE186350	146	AZAMT10	66	BB76450	272	BIE4825	144	BZ158704	220	BZ3208040	209
AUE186360	146	AZAMT12	66	BB76540	272	BIE5525	144	BZ158705	220	BZ3208050	209
AUE186380	146	AZAMT16	66	BB88770	272	BIE5532	144	BZ158706	220	BZ3208060	209

Ref.	pag.	Ref.	pag.	Ref.	pag.	Ref.	pag.	Ref.	pag.	Ref.	pag.
BZSJZ0506	118	BZTABRIBL8	273	BZTPPO30016	175	BZTREZ05050	183	BZTXZP45045	167	CKBC36140MA	275
BZSJZ0608	118	BZTABRINE8	272	BZTPPO30020	175	BZTREZ07050	183	BZTXZP45050	167	CKBC36140RO	275
BZSVCL	195	BZTACON04	99	BZTPPO30025	175	BZTSGA06	118	BZTXZP45060	167	CKBC36140VE	274
BZSVCLMA	195	BZTACON05	99	BZTPPO30030	175	BZTUMAM03	224	BZTXZP45070	167	CKBC36200AZ	275
BZSVNB01	195	BZTACON06	99	BZTPPO35016	175	BZTUMAM04	224	BZTXZP50030	167	CKBC36200MA	275
BZSVNB02	195	BZTACON08	99	BZTPPO35020	175	BZTUMAM05	224	BZTXZP50035	167	CKBC36200RO	275
BZSVNM01	195	BZTACON10	99	BZTPPO35025	175	BZTUMAM06	224	BZTXZP50040	167	CKBC36200VE	274
BZSVNM02	195	BZTACON12	99	BZTPPO35030	175	BZTUMAM08	224	BZTXZP50050	167	CKBC48200AZ	275
BZT8135009	157	BZTALAM06	65	BZTPPO35035	175	BZTUMAM10	224	BZTXZP50060	167	CKBC48200MA	275
BZT8135013	157	BZTALAM08	65	BZTPPO35040	175	BZTUMAM12	224	BZTXZP50070	167	CKBC48200RO	275
BZT8135016	157	BZTALAM10	65	BZTPPO35050	175	BZTXA250050	169	BZTXZP50080	167	CKBC48200VE	274
BZT8135019	157	BZTAME06032	65	BZTPPO40016	175	BZTXA250060	169	BZTXZP60050	167	CKBC48290AZ	275
BZT8139013	157	BZTAME08038	65	BZTPPO40020	175	BZTXA250070	169	BZTXZP60060	167	CKBC48290MA	275
BZT8139016	157	BZTAME08060	65	BZTPPO40025	175	BZTXBP30016	166	BZTXZP60070	167	CKBC48290RO	275
BZT8139019	157	BZTAME10060	65	BZTPPO40030	175	BZTXBP30020	166	BZTXZP60080	167	CKBC48290VE	274
BZT8139025	157	BZTAPLAME	110	BZTPPO40035	175	BZTXBP30025	166	BZZ98503	219	CKBN12225	271
BZT8139032	157	BZTAPLANY	110	BZTPPO40040	175	BZTXBP30030	166	BZZ98504	219	CKBN25080	271
BZT8142009	157	BZTB05030	180	BZTPPO40045	175	BZTXBP35016	166	BZZ98505	219	CKBN25100	271
BZT8142013	157	BZTB05040	180	BZTPPO40050	175	BZTXBP35020	166	BZZ98506	219	CKBN25140	271
BZT8142016	157	BZTB05050	180	BZTPPO40060	175	BZTXBP35025	166	BZZ98508	219	CKBN25160	271
BZT8142019	157	BZTB06030	180	BZTPPO45030	175	BZTXBP35030	166	BZZ98510	219	CKBN25200	271
BZT8142025	157	BZTB06040	180	BZTPPO45035	175	BZTXBP35035	166	BZZ98512	219	CKBN36140	271
BZT8142032	157	BZTB06050	180	BZTPPO45040	175	BZTXBP35040	166	CABA004	106	CKBN36200	271
BZT8142038	157	BZTB06060	180	BZTPPO45045	175	BZTXBP35050	166	CABA005	106	CKBN36300	271
BZT8148016	157	BZTB06070	180	BZTPPO45050	175	BZTXBP40025	166	CABA006	106	CKBN36370	271
BZT8148019	157	BZTB06080	180	BZTPPO45060	175	BZTXBP40030	166	CABA008	106	CKBN48120	271
BZT8148025	157	BZTB07050	180	BZTPPO45070	175	BZTXBP40035	166	CABTC47	128	CKBN48160	271
BZT8148032	157	BZTB07060	180	BZTPPO50030	175	BZTXBP40040	166	CABTC60	128	CKBN48180	271
BZT8148038	157	BZTB07070	180	BZTPPO50035	175	BZTXBP40045	166	CAPA004	107	CKBN48200	271
BZT8148050	157	BZTB08040	180	BZTPPO50040	175	BZTXBP40050	166	CAPA005	107	CKBN48250	271
BZT8148060	157	BZTB08050	180	BZTPPO50050	175	BZTXBP40060	166	CAPA006	107	CKBN48290	271
BZT8155025	157	BZTB08060	180	BZTPPO50060	175	BZTXBP45030	166	CAPA008	107	CKBN48370	271
BZT8155032	157	BZTB08070	180	BZTPPO50070	175	BZTXBP45035	166	CAQU008	79	CKBN76200	271
BZT8155038	157	BZTB08080	180	BZTPPO50080	175	BZTXBP45040	166	CAQU010	79	CKBN76290	271
BZT8155050	157	BZTB08090	180	BZTPPO50100	175	BZTXBP45045	166	CAQU012	79	CKBN76370	271
BZT8242019	158	BZTB08100	180	BZTPPO60040	175	BZTXBP45050	166	CAQU016	79	CKTACOBTRIB6	273
BZT8242025	158	BZTB10050	180	BZTPPO60050	175	BZTXBP45060	166	CAQU020	79	CKTACOBTRIB8	273
BZT8248025	158	BZTB10060	180	BZTPPO60060	175	BZTXBP45070	166	CAQU024	79	CKTACOBTRIN6	272
BZT8248038	158	BZTB10080	180	BZTPPO60070	175	BZTXBP50030	166	CAQU030	79	CKTACOBTRIN8	272
BZT9650410Z	217	BZTBTIS10	97	BZTPPO60080	175	BZTXBP50035	166	CFBL	194	CMBRPOS33	122
BZT9650420Z	217	BZTCCA05030	95	BZTPPO60090	175	BZTXBP50040	166	CIPEI208	258	CMBRPOS40	122
BZT9650430Z	217	BZTCCA05050	95	BZTPPO60100	175	BZTXBP50050	166	CIPEI708	258	CMBRPOS42	122
BZT9650510Z	217	BZTCCA06040	95	BZTPPOT04	98	BZTXBP50060	166	CIPEA21708	258	CMBRPOS48	122
BZT9650520Z	217	BZTCCA06050	95	BZTPPOT05	98	BZTXBP50070	166	CIPRI208	259	CMBRPOS50	122
BZT9650525Z	217	BZTCCA06060	95	BZTPPOT06	98	BZTXBP50080	166	CIPRI908	259	CMBRPOS60	122
BZT9650530Z	217	BZTCCA06070	95	BZTPPOT08	98	BZTXBP60050	166	CKBB12225	272	CMBRTEN48	122
BZT9650620Z	217	BZTCCA08060	95	BZTPPOTS05	97	BZTXBP60060	166	CKBB25080	272	CMTAPON33	122
BZT9650630Z	217	BZTCCA08080	95	BZTPPOTS06	97	BZTXBP60070	166	CKBB25100	272	CMTAPON40	122
BZT9650640Z	217	BZTCCA08100	95	BZTPPOTS08	97	BZTXBP60080	166	CKBB25140	272	CMTAPON42	122
BZT9850306Z	216	BZTCCA08120	95	BZTPTPADBE	229	BZTXZP30016	167	CKBB25160	272	CMTAPON48	122
BZT9850310Z	216	BZTN4S05	96	BZTPTPADBL	229	BZTXZP30020	167	CKBB25200	272	CMTAPON50	122
BZT9850316Z	216	BZTN4S06	96	BZTPTPADCA	229	BZTXZP30025	167	CKBB36140	272	CMTAPON60	122
BZT9850320Z	216	BZTN4S08	96	BZTPTPADCE	229	BZTXZP30030	167	CKBB36200	272	CMTAPOS33	122
BZT9850330Z	216	BZTN4S10	96	BZTPTPADGR	229	BZTXZP35016	167	CKBB36300	272	CMTAPOS40	122
BZT9850416Z	216	BZTN4S12	96	BZTPTPADHA	229	BZTXZP35020	167	CKBB36370	272	CMTAPOS42	122
BZT9850420Z	216	BZTNXA08080	91	BZTPTPADNE	229	BZTXZP35025	167	CKBB48120	272	CMTAPOS48	122
BZT9850430Z	216	BZTNXA08100	91	BZTPTPADNO	229	BZTXZP35030	167	CKBB48160	272	CMTENSAL	119
BZT9850510Z	216	BZTNXA08120	91	BZTPTPADPI	229	BZTXZP35035	167	CKBB48180	272	CMTENSOTO	119
BZT9850520Z	216	BZTNXA10080	91	BZTPTPADRO	229	BZTXZP35040	167	CKBB48200	272	CMTENSOVE	119
BZT9850525Z	216	BZTNXA10100	91	BZTPTPADSA	229	BZTXZP35050	167	CKBB48250	272	CMUNAAGUJ	122
BZT9850530Z	216	BZTNXA10120	91	BZTRA6050	70	BZTXZP40025	167	CKBB48290	272	COAR08060	240
BZT9850540Z	216	BZTNXE08080	91	BZTRA6060	70	BZTXZP40030	167	CKBB48370	272	COARI0060	240
BZT9850610Z	216	BZTNXE08100	91	BZTRA6080	70	BZTXZP40035	167	CKBB76200	272	COAS08060	322
BZT9850616Z	216	BZTNXE08120	91	BZTRA8070	70	BZTXZP40040	167	CKBB76290	272	COSOI5400	322
BZT9850620Z	216	BZTNXE10080	91	BZTRA8090	70	BZTXZP40045	167	CKBB76370	272	COSOI5450	322
BZT9850625Z	216	BZTNXE10100	91	BZTRA8110	70	BZTXZP40050	167	CKBC25100AZ	275	COSOI5500	322
BZT9850630Z	216	BZTNXE10120	91	BZTRA8130	70	BZTXZP40060	167	CKBC25100MA	275	COSO20400	322
BZT9850640Z	216	BZTPPO25016	175	BZTRA8150	70	BZTXZP45030	167	CKBC25100RO	275	COSO20450	322
BZT9850650Z	216	BZTPPO25020	175	BZTREPV0550	183	BZTXZP45035	167	CKBC25100VE	274	COSO20500	322
BZT9850660Z	216	BZTPPO25025	175	BZTREPV0750	183	BZTXZP45040	167	CKBC36140AZ	275	CPAC300453	126

Ref.	pag.	Ref.	pag.	Ref.	pag.	Ref.	pag.	Ref.	pag.	Ref.	pag.
CPAC300703	126	D603905025	214	D603912060	214	D692110040	212	D91206020	213	D931810035	211
CPGV012	126	D603905030	214	D603912070	214	D692110050	212	D91206025	213	D931810040	211
CPGV030	126	D603905035	214	D603912080	214	D692112025	212	D91206030	213	D931810045	211
CPMV020	126	D603905040	214	D603912100	214	D692112030	212	D91206035	213	D931810050	211
CPMV045	126	D603905045	214	D603912120	214	D692112035	212	D91206040	213	D931810060	211
CPMV090	126	D603905050	214	D603912140	214	D692112040	212	D91206045	213	D931810070	211
CPMV150	126	D603905060	214	D603912160	214	D692112045	212	D91206050	213	D931810080	211
CPPA023	126	D603905070	214	D603912180	214	D692112050	212	D91206060	213	D931810090	211
CPPA075	126	D603905080	214	D603912200	214	D692112060	212	D91208010	213	D931810100	211
CPPA150	126	D603906016	214	D603912220	214	D692304	220	D91208012	213	D931810110	211
CSB0104010	302	D603906020	214	D603912240	214	D692305	220	D91208016	213	D931810120	211
CSB0108010	302	D603906025	214	D603912260	214	D692306	220	D91208020	213	D931810130	211
D12503	221	D603906030	214	D603912280	214	D692308	220	D91208025	213	D931810140	211
D12504	221	D603906035	214	D603912300	214	D692310	220	D91208030	213	D931810150	211
D12505	221	D603906040	214	D603108016	215	D692312	220	D91208035	213	D931812040	211
D12506	221	D603906045	214	D60810035	215	D692314	220	D91208040	213	D931812045	211
D12508	221	D603906050	214	D60810040	215	D692316	220	D91208045	213	D931812050	211
D12510	221	D603906060	214	D60810045	215	D69231M08	220	D91208050	213	D931812060	211
D12512	221	D603906070	214	D60810050	215	D69231M10	220	D91208060	213	D931812070	211
D12514	221	D603906080	214	D60810060	215	D69231M12	220	D91208070	213	D931812080	211
D12516	221	D603906090	214	D60810040	215	D902103	222	D91208080	213	D931812090	211
D12518	221	D603906100	214	D60811045	215	D902104	222	D91210016	213	D931812100	211
D12520	221	D603906110	214	D60811050	215	D902105	222	D91210020	213	D931812110	211
D12522	221	D603906120	214	D60811060	215	D902106	222	D91210025	213	D931812120	211
D12524	221	D603906130	214	D60811070	215	D902108	222	D91210030	213	D931812130	211
D12527	221	D603906140	214	D60811080	215	D902110	222	D91210035	213	D931812140	211
D12530	221	D603906150	214	D60811090	215	D902112	222	D91210040	213	D931812150	211
D12533	221	D603908016	214	D60812040	215	D902114	222	D91210045	213	D931814050	211
D12536	221	D603908020	214	D60812045	215	D902116	222	D91210050	213	D931814060	211
D125IM04	221	D603908025	214	D60812050	215	D902118	222	D91210060	213	D931814070	211
D125IM05	221	D603908030	214	D60812060	215	D902120	222	D91210070	213	D931814080	211
D125IM06	221	D603908035	214	D60812070	215	D902122	222	D91210080	213	D931814090	211
D125IM08	221	D603908040	214	D60812080	215	D902124	222	D91210090	213	D931814100	211
D125IM10	221	D603908045	214	D60812090	215	D90211M04	222	D91210100	213	D931814110	211
D125IM12	221	D603908050	214	D60812100	215	D90211M05	222	D91212020	213	D931814120	211
D125IM14	221	D603908060	214	D6798A03	224	D90211M06	222	D91212025	213	D931814130	211
D125IM16	221	D603908070	214	D6798A04	224	D90211M08	222	D91212030	213	D931814140	211
D125IM18	221	D603908080	214	D6798A05	224	D90211M10	222	D91212035	213	D931814150	211
D125IM20	221	D603908090	214	D6798A06	224	D90211M12	222	D91212040	213	D931816050	211
D125IM22	221	D603908100	214	D6798A08	224	D90211M14	222	D91212045	213	D931816060	211
D125IM24	221	D603908110	214	D6798A10	224	D90211M16	222	D91212050	213	D931816070	211
D12703	223	D603908120	214	D6798A12	224	D90211M18	222	D91212060	213	D931816080	211
D12704	223	D603908130	214	D6798A14	224	D90211M20	222	D91212070	213	D931816090	211
D12705	223	D603908140	214	D6798A16	224	D90211M22	222	D91212080	213	D931816100	211
D12706	223	D603908150	214	D692105010	212	D90211M24	222	D91212090	213	D931816110	211
D12708	223	D603910020	214	D692105012	212	D91204008	213	D91212100	213	D931816120	211
D12710	223	D603910025	214	D692105016	212	D91204010	213	D91212110	213	D931816130	211
D12712	223	D603910030	214	D692105020	212	D91204012	213	D91212120	213	D931816140	211
D12714	223	D603910035	214	D692105025	212	D91204016	213	D931806030	211	D931816150	211
D12716	223	D603910040	214	D692105030	212	D91204020	213	D931806035	211	D931818060	211
D12718	223	D603910045	214	D692106010	212	D91204025	213	D931806040	211	D931818070	211
D12720	223	D603910050	214	D692106012	212	D91204030	213	D931806045	211	D931818080	211
D12722	223	D603910060	214	D692106016	212	D91204035	213	D931806050	211	D931818090	211
D12724	223	D603910070	214	D692106020	212	D91204040	213	D931806060	211	D931818100	211
D12727	223	D603910080	214	D692106025	212	D91204045	213	D931806070	211	D931818110	211
D12730	223	D603910090	214	D692106030	212	D91204050	213	D931808030	211	D931818120	211
D12736	223	D603910100	214	D692106035	212	D91205008	213	D931808035	211	D931818130	211
D127IM08	223	D603910110	214	D692106040	212	D91205010	213	D931808040	211	D931818140	211
D127IM10	223	D603910120	214	D692108016	212	D91205012	213	D931808045	211	D931818150	211
D127IM12	223	D603910130	214	D692108020	212	D91205016	213	D931808050	211	D931820060	211
D158704	220	D603910140	214	D692108025	212	D91205020	213	D931808060	211	D931820070	211
D158705	220	D603910150	214	D692108030	212	D91205025	213	D931808070	211	D931820080	211
D158706	220	D603910160	214	D692108035	212	D91205030	213	D931808080	211	D931820090	211
D158708	220	D603910180	214	D692108040	212	D91205035	213	D931808090	211	D931820100	211
D158710	220	D603910200	214	D692108050	212	D91205040	213	D931808100	211	D931820110	211
D158712	220	D603912030	214	D692108060	212	D91205045	213	D931808110	211	D931820120	211
D158714	220	D603912035	214	D692110020	212	D91205050	213	D931808120	211	D931820130	211
D158716	220	D603912040	214	D692110025	212	D91206010	213	D931808130	211	D931820140	211
D603905016	214	D603912045	214	D692110030	212	D91206012	213	D931808140	211	D931820150	211
D603905020	214	D603912050	214	D692110035	212	D91206016	213	D931808150	211	D93304008	208

Ref.	pag.	Ref.	pag.	Ref.	pag.	Ref.	pag.	Ref.	pag.	Ref.	pag.
D93304010	208	D93312050	208	D9331M05050	210	D93412	218	EKMULROB	326	ESDR08110	315
D93304012	208	D93312060	208	D9331M06010	210	D93414	218	EKMULTEN	324	ESDR08120	315
D93304016	208	D93312070	208	D9331M06016	210	D93416	218	EKMULTOL	324	ESDR08130	315
D93304020	208	D93312080	208	D9331M06020	210	D93418	218	EKMULWCB	325	ESDR10080	315
D93304025	208	D93312090	208	D9331M06025	210	D93420	218	EMI00	289	ESDR10100	315
D93304030	208	D93312100	208	D9331M06030	210	D93422	218	EMI45	289	ESDR10110	315
D93304035	208	D93312110	208	D9331M06035	210	D93424	218	EMI90	289	ESDR10120	315
D93304040	208	D93312120	208	D9331M06040	210	D93427	218	EMPTC45	128	ESDR10130	315
D93304045	208	D93314030	208	D9331M06050	210	D93430	218	EMPTC47	128	ESDR10140	315
D93304050	208	D93314035	208	D9331M08016	210	D93433	218	EMPTC60	128	ESDR10150	315
D93304060	208	D93314040	208	D9331M08020	210	D93436	218	EMPX4121	293	ESDR10180	315
D93305010	208	D93314045	208	D9331M08025	210	D9341M04	218	EMPX54115	296	ESDR10200	315
D93305012	208	D93314050	208	D9331M08030	210	D9341M05	218	EMX1302	292	ESTRINV40N	182
D93305016	208	D93314060	208	D9331M08035	210	D9341M06	218	EMX4502	292	ESTRINV40Z	182
D93305020	208	D93314070	208	D9331M08040	210	D9341M08	218	EMX9002	292	EVH06	119
D93305025	208	D93314080	208	D9331M08050	210	D9341M10	218	EMX9004	292	EVH08	119
D93305030	208	D93314090	208	D9331M08060	210	D9341M12	218	EMZ00	289	EVH10	119
D93305035	208	D93314100	208	D9331M08070	210	D9341M14	218	EMZ45	289	EVH12	119
D93305040	208	D93314110	208	D9331M08080	210	D9341M16	218	EMZ90	289	EVH14	119
D93305045	208	D93314120	208	D9331M08090	210	D9341M18	218	EPS6072	70	EVH16	119
D93305050	208	D93316030	208	D9331M08100	210	D9341M20	218	EPS6092	70	EVH18	119
D93305060	208	D93316035	208	D9331M10020	210	D9341M22	218	EPS6112	70	EVH20	119
D93305070	208	D93316040	208	D9331M10025	210	D9341M24	218	EPS6132	70	EVH22	119
D93306010	208	D93316045	208	D9331M10030	210	D9851M04	219	EPS6152	70	EVH24	119
D93306012	208	D93316050	208	D9331M10035	210	D9851M05	219	EPS6182	70	EVH30	119
D93306016	208	D93316060	208	D9331M10040	210	D9851M06	219	EQ8808110	79	EVH36	119
D93306020	208	D93316070	208	D9331M10050	210	D9851M08	219	EQ8810130	79	EVM08	120
D93306025	208	D93316080	208	D9331M10060	210	D9851M10	219	EQ8812160	79	EVM10	120
D93306030	208	D93316090	208	D9331M10070	210	D9851M12	219	EQ8816190	79	EVM12	120
D93306035	208	D93316100	208	D9331M10080	210	D9851M14	219	EQ8820260	79	EVM14	120
D93306040	208	D93316110	208	D9331M10090	210	D9851M16	219	EQ8824300	79	EVM16	120
D93306045	208	D93316120	208	D9331M10100	210	D9851M18	219	EQA208110	79	EVM18	120
D93306050	208	D93318030	208	D9331M12020	210	D9851M20	219	EQA210130	79	EVM20	120
D93306060	208	D93318035	208	D9331M12030	210	D9851M22	219	EQA212160	79	EVM22	120
D93306065	208	D93318040	208	D9331M12040	210	D9851M24	219	EQA216190	79	EVM24	120
D93306070	208	D93318045	208	D9331M12050	210	DOMTA10	47	EQA220260	79	EVM30	120
D93308016	208	D93318050	208	D9331M12060	210	DOMTA20	47	EQA224300	79	EVM36	120
D93308020	208	D93318060	208	D9331M12070	210	DZ98503	219	EQA230330	79	EVM42	120
D93308025	208	D93318070	208	D9331M12080	210	DZ98504	219	EQA408110	79	EVM48	120
D93308030	208	D93318080	208	D9331M12090	210	DZ98505	219	EQA410130	79	EXHBM06	64
D93308035	208	D93318090	208	D9331M12100	210	DZ98506	219	EQA412160	79	EXHBM08	64
D93308040	208	D93318100	208	D9331M14030	210	DZ98508	219	EQA416190	79	EXHBM08C	64
D93308045	208	D93318110	208	D9331M14040	210	DZ98510	219	EQA420260	79	EXHBM10	64
D93308050	208	D93318120	208	D9331M14050	210	DZ98512	219	EQA424300	79	EXHBM10C	64
D93308060	208	D93320030	208	D9331M14060	210	DZ98514	219	EQA430330	79	EXHBM12	64
D93308070	208	D93320035	208	D9331M14070	210	DZ98516	219	EQAC08110	79	EXHBM12C	64
D93308080	208	D93320040	208	D9331M14080	210	DZ98518	219	EQAC10130	79	EXHBM16	64
D93308090	208	D93320045	208	D9331M14100	210	DZ98520	219	EQAC10190	79	EXHBM20	64
D93308100	208	D93320050	208	D9331M16030	210	DZ98522	219	EQAC12160	79	FG60BAT	139
D93308110	208	D93320060	208	D9331M16040	210	DZ98524	219	EQACT2220	79	FG60CAR	139
D93308120	208	D93320070	208	D9331M16050	210	DZ98527	219	EQAC16190	79	FG60GAS	139
D93310016	208	D93320080	208	D9331M16060	210	DZ98530	219	EQAC16250	79	FG60GUN	136
D93310020	208	D93320090	208	D9331M16070	210	EKHUEFTG	327	EQAC20260	79	FG60GUNEL	136
D93310025	208	D93320100	208	D9331M16080	210	EKHUEFTL	327	EQAC20350	79	FGABRA15	138
D93310030	208	D93320110	208	D9331M16090	210	EKHUEFTP	326	EQAC24300	79	FGABRA20	138
D93310035	208	D93320120	208	D9331M16100	210	EKHUEILU	326	EQAC24380	79	FGABRA25	138
D93310040	208	D9331M04010	210	D9331M18030	210	EKMACEFTG	327	EQAC30330	79	FGARAM25	137
D93310045	208	D9331M04016	210	D9331M18040	210	EKMACEFTL	326	ESDA208060	315	FGARAM25SEP	137
D93310050	208	D9331M04020	210	D9331M18050	210	EKMACEFTP	326	ESDA210060	315	FGBASEGR	138
D93310060	208	D9331M04025	210	D9331M18060	210	EKMACEILU	326	ESDR06040	315	FGBASENE	138
D93310070	208	D9331M04030	210	D9331M18070	210	EKMULAC	324	ESDR06050	315	FGCAEL	139
D93310080	208	D9331M04035	210	D9331M18080	210	EKMULAV08	325	ESDR06060	315	FGCL15	137
D93310090	208	D9331M04040	210	D9331M18090	210	EKMULAV10	325	ESDR06070	315	FGCL20	137
D93310100	208	D9331M05010	210	D9331M18100	210	EKMULCAL	325	ESDR06080	315	FGCL25	137
D93312020	208	D9331M05016	210	D93403	218	EKMULCAN	324	ESDR08050	315	FGCL30	137
D93312025	208	D9331M05020	210	D93404	218	EKMULCIS	325	ESDR08060	315	FGCL35	137
D93312030	208	D9331M05025	210	D93405	218	EKMULFAE	324	ESDR08070	315	FGCL40	137
D93312035	208	D9331M05030	210	D93406	218	EKMULFAL	327	ESDR08080	315	FGCLCAR40	139
D93312040	208	D9331M05035	210	D93408	218	EKMULFAP	327	ESDR08090	315	FGCLH15	137
D93312045	208	D9331M05040	210	D93410	218	EKMULRAD	325	ESDR08100	315	FGCLH17	137

Ref.	pag.	Ref.	pag.	Ref.	pag.	Ref.	pag.	Ref.	pag.	Ref.	pag.
FGCLH19	137	FPPISCT12	135	GRNATTV	281	HECLOM12	63	INSI865	108	KTPSE0335	303
FGCLH22	137	FPPISPL08	135	GRNE060	281	HECLOM12D	63	INVA27050	182	KTPSE0340	303
FGCLH27	137	GAFOM06Z	313	GRNE070	281	HECLOM16	63	INVA27060	182	LSAB6I012	252
FGCLH32	137	GAFOM08Z	313	GRNE080	281	HEHCM08	64	INVA27070	182	LSAB6I015	252
FGIMAN	139	GAFOM10Z	313	GRNE090	281	HEHCM10	64	INVA27080	182	LSAB6I016	252
FGPLET	137	GAFOM12Z	313	GRNEI00	281	HEHCM12	64	INVN6040	182	LSAB6I018	252
FI6310	148	GAFOM16Z	313	GRNEI20	281	HEHOM06	63	INVN6050	182	LSAB6I022	252
FI63115	148	GDZ03	121	GRZ05	120	HEHOM08	63	INVN6060	182	LSAB6I028	252
FI63120	148	GDZ04	121	GRZ06	120	HEHOM10	63	INVN6070	182	LSABD6012	251
FI63125	148	GDZ05	121	GRZ08	120	HEHOM12	63	INVN7030	182	LSABD6015	251
FI63130	148	GDZ06	121	GRZ10	120	HEHOM12D	63	INVN7040	182	LSABD6018	251
FI63150	148	GDZ08	121	GRZ11	120	HEHOM16	63	INVN7050	182	LSABD6022	251
FI63160	148	GDZ10	121	GRZ12	120	HEHOM20	63	INVN7060	182	LSABD6028	251
FICAAB080	280	GDZ13	121	GRZ14	120	HENOM06	64	INVN7070	182	LSABDI0012	252
FICAAB119	280	GDZ15	121	GRZ16	120	HENOM08	64	INVN7080	182	LSABDI0015	252
FICACL13	280	GDZ18	121	GRZ18	120	HENOM10	64	INVN7090	182	LSABDI0018	252
FICACL26	280	GDZ20	121	GRZ20	120	HENOM12	64	INVZ6040	181	LSABDI0022	252
FICAPDI60	280	GDZ24	121	GRZ22	120	HENOM16	64	INVZ6050	181	LSABGAT022	242
FICAPS080	280	GESPM08ZE	313	GRZ25	120	HENOM20	64	INVZ6060	181	LSABGAT028	242
FP08GUN	132	GESPMIOZE	313	GRZ28	120	HENSM08	64	INVZ6070	181	LSABGAT035	242
FP12GUN	132	GLO351515	287	GRZ32	120	HENSM10	64	INVZ7030	181	LSABGAT040	242
FPAM0837	133	GLO357510	287	GRZ36	120	HENSM12	64	INVZ7040	181	LSABGAT048	242
FPAM0851	133	GMA035	296	GRZ42	120	HENSM16	64	INVZ7050	181	LSABGAT060	242
FPAP085166	133	GMA040	296	GRZ45	120	HOCRM647	127	INVZ7060	181	LSABGAT075	242
FPC303708	133	GMZ08012	194	GRZ50	120	HOCRM660	127	INVZ7070	181	LSABGAT090	242
FPC304708	133	GMZ10016	194	GSTC040080	300	HOCUM647	127	INVZ7080	181	LSABGATT10	242
FPCC0816	133	CMZ12020	194	GSTC080120	300	HP75072	54	INVZ7090	181	LSABCS015	261
FPCC0819	133	GMZ15026	194	GSTU040055	300	HP75092	54	IPAAR09	100	LSABCS018	261
FPCCG1612	134	GMZ17030	194	HARM03026	192	HP75112	54	IPAAR12	100	LSABCS022	261
FPCCG1912	134	CMZ19035	194	HARM04035	192	HP75132	54	IPAGN09	100	LSABCS028	277
FPCCG1612	134	GPC271812	286	HARM05037	192	HP75152	54	IPAGN12	100	LSABCS032	277
FPCCG1912	134	GPC283018	286	HARM06050	192	HP75182	54	IPAGR09	100	LSABCS038	277
FPCL0816	133	GPC351312	286	HARM08060	192	HPZ75072	54	IPAGR12	100	LSABCS042	277
FPCL0819	133	GPC384020	286	HCM06	65	HPZ75092	54	IPATO09	100	LSABCS048	277
FPCL0825	133	GPC402015	286	HCM08	65	HPZ75112	54	IPATO12	100	LSABCS052	277
FPCL0827	133	GPI271812	286	HCM10	65	HPZ75132	54	KCGPD0100	303	LSABCS058	277
FPCL0832	133	GPI283015	286	HCRM03026	192	HPZ75152	54	KCGPD0135	303	LSABCS062	277
FPCL0838	133	GPO351515	287	HCRM04035	192	HPZ75182	54	KCGPD0140	303	LSABCS068	277
FPCL0844	133	GPO357510	287	HCRM05037	192	HPZ75212	54	KCGPX0235	303	LSABCS072	277
FPCL0851	133	GPP271812	286	HCRM06050	192	HR75072	54	KCGPX0240	303	LSABCS078	277
FPCL0857	133	GPV251120	286	HCRM08060	192	HR75092	54	KCGPX0335	303	LSABCS082	277
FPCL0864	133	GPX2M412120	290	HCRM10065	192	HR75112	54	KCGPX0340	303	LSABCS088	277
FPCL0870	133	GPX2M414120	290	HCRM12075	192	HR75132	54	KCPXA0235	302	LSABCS092	277
FPCL2212	134	CPX412115	290	HEI665032	54	INCO421	108	KCPXA0240	302	LSABCS098	277
FPCL2712	134	GPX412120	290	HEI665045	54	INCO432	108	KCPXA0335	302	LSABCS102	277
FPCL3212	134	GPX412125	290	HEI665057	54	INCO438	108	KCPXA0340	302	LSABCS108	277
FPCL3712	134	CPX414115	290	HEI665070	54	INCO446	108	KCPXD0100	302	LSABCS112	277
FPCL4212	134	GPX414120	290	HEI665080	54	INCO459	108	KCPXD0135	302	LSABCS118	277
FPCL4712	134	GPX414125	290	HEI665100	54	INCO537	108	KCPXD0140	302	LSABCS124	277
FPCLD2212	135	GPXS4115012	296	HEI665125	54	INCO552	108	KCPSE0235	303	LSABCS130	277
FPCLD2712	135	GPXS4115162	296	HE65032	54	INCO565	108	KCPSE0240	303	LSABCS136	277
FPCLD3212	135	GPXS4115212	296	HE65045	54	INCO580	108	KCPSE0335	303	LSABCS142	277
FPCLD3712	135	GPXS4115325	296	HE65057	54	INCO637	108	KCPSE0340	303	LSABCS148	277
FPCLD4212	135	GPZ201010	286	HE65070	54	INCO652	108	KFRSC3050	296	LSABCS154	277
FPCLD4712	135	GPZ250808	286	HE65080	54	INCO665	108	KFSAU10160	300	LSABCS160	277
FPCR0812	134	GRBL001	281	HE65100	54	INCO680	108	KFSAU10200	300	LSABCS166	277
FPCR0822	134	GRBL002	281	HE65125	54	INHE837	108	KFSFIM08	298	LSABCS172	277
FPCR0827	134	GRBL003	281	HEA4M06	63	INHE855	108	KFSFLM08	298	LSABCS178	277
FPCRAM	132	GRBL010	281	HEA4M08	63	INHE865	108	KFSMA10200	300	LSABCS184	277
FPCRM80812	134	GRBL020	281	HEA4M10	63	INPINZANI	109	KFSMA10250	300	LSABCS190	277
FPCRM80827	134	CRBL030	281	HEA4M12	63	INPISANIN	109	KFSRV10250	301	LSABCS196	277
FPCRRO	132	GRBL040	281	HEA4M16	63	INSI421	108	KFSRV12350	301	LSABCS202	277
FPCT3212	135	GRBL050	281	HEA4M20	63	INSI432	108	KIT MO-PS	75	LSABCS208	277
FPP3VE	132	GRBL060	281	HEC4M06	63	INSI438	108	KITINPIN01	109	LSABCS214	277
FPP4AM	132	GRBL070	281	HEC4M08	63	INSI537	108	KTGPX0235	303	LSABCS220	277
FPP5RO	132	GRBL080	281	HEC4M10	63	INSI552	108	KTGPX0240	303	LSABCS226	277
FPPI081613	134	GRBL090	281	HEC4M12	63	INSI565	108	KTGPX0335	303	LSABCS232	277
FPPISCL08	135	GRBL100	281	HECLOM06	63	INSI637	108	KTGPX0340	303	LSABCS238	277
FPPISCL12	135	GRBL120	281	HECLOM08	63	INSI652	108	KTPSE0235	303	LSABCS244	277
FPPISCM12	135	GRBL140	281	HECLOM10	63	INSI665	108	KTPSE0240	303	LSABCS250	277

ÍNDICE REFERENCIAS

Ref.	pag.	Ref.	pag.	Ref.	pag.	Ref.	pag.	Ref.	pag.	Ref.	pag.
LSABPI028	255	LSAH10090	43	LSMOTN20085	78	MEDUB10	98	MOPISNEU	78	NBR4838	151
LSABPI032	255	LSAH10120	43	LSPAESM04	107	MI06045	45	MOPISP3385	78	NBR4845	151
LSABPI040	255	LSAH12090	43	LSPAESM05	107	MI06060	45	MOPISP3585	78	NBR4850	151
LSABPRG15	278	LSAH12110	43	LSPAESM06	107	MI06080	45	MOPISPR	78	NUXSM0841	299
LSABPRG20	278	LSAH16125	43	LSPAGAM04	107	MI06120	45	MOPISPUR6	78	OMEM06	127
LSABPRG25	278	LSASF008016	257	LSPAGAM05	107	MI06140	45	MOPISSI	78	P100KOM10	163
LSABPU016	255	LSASF012022	257	LSPAGAM06	107	MI06160	45	MOPISTO	78	P100VEK	163
LSABPU018	255	LSASF016027	257	LSTALAM06	65	MI06170	45	MOP300	75	P100VEK10	163
LSABPU020	255	LSASF020032	257	LSTALAM08	65	MI06180	45	MOP300EP	75	P100VEK13	163
LSABPU022	255	LSASF025040	257	LSTALAM10	65	MI08050	45	MOP3410	75	P103925Z	161
LSABPU025	255	LSASF030045	257	LSTCCA05025	95	MI08075	45	MOPSP300	75	P103930Z	161
LSABPU028	255	LSASF035050	257	LSTCCA05030	95	MI08090	45	MOPSP410	75	P103938Z	161
LSABPU032	255	LSASF040060	257	LSTCCA05035	95	MI08115	45	MOPU300	75	P103945Z	161
LSABPU037	255	LSASF050070	257	LSTCCA05050	95	MI10070	45	MOPU410	75	P204316Z	161
LSABPU040	255	LSBAESM04	106	LSTCCA06035	95	MI10090	45	MOPUR30385	77	P204319Z	161
LSABPU050	255	LSBAESM05	106	LSTCCA06040	95	MI10120	45	MOPUR30585	77	P204322Z	161
LSABPU063	255	LSBAESM06	106	LSTCCA06050	95	MI10150	45	MOPURE600	77	P204325	161
LSABRETO22	236	LSBAGAM04	106	LSTCCA06060	95	MI12075	45	MORCANU	78	P204325Z	161
LSABRETO28	236	LSBAGAM05	106	LSTCCA06070	95	MI12090	45	MORCANU	78	P204330	161
LSABRETO35	236	LSBAGAM06	106	LSTCCA08060	95	MI12110	45	MORCEPKIT	78	P204330Z	161
LSABRETO40	236	LSCABA004	106	LSTCCA08080	95	MI12140	45	MOTM12100	78	P204338	161
LSABRETO48	236	LSCABA005	106	LSTCCC05025	94	MI16090	45	MOTM16100	78	P204338Z	161
LSABRETO60	236	LSCABA006	106	LSTCCC05030	94	MI16145	45	MOTM22100	78	P204345	161
LSABRETO75	236	LSCAPA004	107	LSTCCC05035	94	MI16170	45	MOTN12050	78	P204345Z	161
LSABRETO90	236	LSCAPA005	107	LSTCCC05050	94	MI20120	45	MOTN12080	78	P204355	161
LSABRETT10	236	LSCAPA006	107	LSTCCC06035	94	MI20170	45	MOTN15085	78	P204355Z	161
LSABRETT25	236	LSESDR06080	315	LSTCCC06040	94	MI20220	45	MOTN15130	78	P304825	161
LSABRIT022	238	LSESDR08060	315	LSTCCC06050	94	MIA406045	44	MOTN20085	78	P304838	161
LSABRIT028	238	LSESDR08080	315	LSTCCC06060	94	MIA406060	44	MOTRO08	78	P403913Z	162
LSABRIT035	238	LSESDR08100	315	LSTCCC06070	94	MIA406080	44	MOTRO10	78	P403916	161
LSABRIT040	238	LSESDR08120	315	LSTCCC08060	94	MIA408050	44	MOTRO12	78	P403916Z	162
LSABRIT048	238	LSESDR10080	315	LSTCCC08080	94	MIA408075	44	MOV300	76	P403919	161
LSABRIT060	238	LSESDR10100	315	LSTNXA08080	91	MIA408090	44	MOV410	76	P403919Z	162
LSABRIT075	238	LSESDR10120	315	LSTNXA08100	91	MIA408115	44	MOV5300	76	P403925	161
LSABRIT090	238	LSHENOM06	64	LSTNXA08120	91	MIA410070	44	MOV5410	76	P403925Z	162
LSABRIT110	238	LSHENOM08	64	LSTNXA10080	91	MIA410090	44	MSCAHT	85	P403932	161
LSABTA0630	313	LSHENOM10	64	LSTNXA10100	91	MIA410120	44	MSCATP	85	P403932Z	162
LSABTA0640	313	LSHP75072	54	LSTNXE08080	91	MIA410150	44	MSPRB290	81	P403938	161
LSABTA0650	313	LSHP75092	54	LSTNXE08100	91	MIA412075	44	MSPRC290	81	P403938Z	162
LSABTA0840	313	LSHP75112	54	LSTNXE08120	91	MIA412090	44	MSPRM290	81	P50M413Z	162
LSABTA0860	313	LSHP75132	54	LSTNXE10080	91	MIA412110	44	MSPRM290	81	P50M416	162
LSABTAB0630	313	LSINCO432	108	LSTNXE10100	91	MIA412140	44	MSSF290	81	P50M416Z	162
LSABTAB0640	313	LSINCO438	108	LSVRSE06030	311	MIA416090	44	MSTR290	81	P50M419	162
LSABTAB0650	313	LSINCO446	108	MAMB6018	127	MIA416145	44	NBP3513	153	P50M419Z	162
LSABTD018	279	LSINCO537	108	MAE0620	311	MIA416170	44	NBP3516	153	P50M425	162
LSABTD022	279	LSINCO552	108	MAE0630	311	MIA420120	44	NBP3519	153	P50M425Z	162
LSABTS018	279	LSINCO637	108	MAE0825	311	MIA420170	44	NBP3525	153	P50M432	162
LSABTS022	279	LSINCO652	108	MAE1030	311	MIA420220	44	NBP4216	153	P50M432Z	162
LSACHA08C	61	LSMAE0630	311	MAE1235	311	MLMULT101	197	NBP4219	153	P50M438	162
LSACHA10C	61	LSMAE0825	311	MAE1650	311	MLMULT201	197	NBP4225	153	P704855	162
LSACHG08C	60	LSMAE1030	311	MAE2060	311	MLMULT301	197	NBP4232	153	P704865	162
LSACHG10C	60	LSMAR0420	312	MAMH0610	312	MLPLAT101	197	NBP4238	153	P704880	162
LSACHT08C	57	LSMAR0630	312	MAMH0620	312	MLPLAT201	197	NBP4825	153	P704895	162
LSACHT08L	57	LSMAR0830	312	MAMH0630	312	MLPLAT301	197	NBP4832	153	P70TPBL	162
LSACHT10C	57	LSMAR1030	312	MAMH0640	312	MLTBOPI01	196	NBP4838	153	P70TPNG	162
LSACHT10L	57	LSMI08075	45	MAMH0650	312	MLTPOPPI01	196	NBP4850	153	P903510	162
LSACHT12C	57	LSMI08090	45	MAR0420	312	MLTPOPOTI01	197	NBR3509	151	P904017	162
LSACHT12L	57	LSMI10070	45	MAR0620	312	MLTPOPOT201	197	NBR3513	151	PACC15015	193
LSACHT16C	57	LSMI10090	45	MAR0630	312	MLTPOPOT301	197	NBR3516	151	PACC15020	193
LSACHTA208C	57	LSMI10120	45	MAR0825	312	MOBOMBA	78	NBR3519	151	PACC15025	193
LSACHTA208L	57	LSMI12110	45	MAR0830	312	MOES06070	78	NBR4213	151	PACC20025	193
LSACHTA210C	57	LSMIA408075	44	MARI030	312	MOES08110	78	NBR4216	151	PACC20030	193
LSACHTA210L	57	LSMIA410090	44	MARI235	312	MOESI0115	78	NBR4219	151	PACC20035	193
LSACHTA212C	57	LSMIA412110	44	MARI650	312	MOESI2110	78	NBR4225	151	PACC20040	193
LSACHTA212L	57	LSMOES06070	78	MAR5322	312	MOH300	76	NBR4232	151	PACC20045	193
LSAH06060	43	LSMOES08110	78	MARI0830	312	MOH410	76	NBR4238	151	PACC20050	193
LSAH08060	43	LSMOESI0115	78	MARI030	312	MOHW300	76	NBR4816	151	PACP22520	193
LSAH08075	43	LSMOESI2110	78	MEDUB06	98	MOHW410	76	NBR4819	151	PACP22525	193
LSAH08090	43	LSMOTN12050	78	MEDUB07	98	MOP300	75	NBR4825	151	PACP22530	193
LSAH10070	43	LSMOTN15085	78	MEDUB08	98	MOP410	75	NBR4832	151	PACP25040	193

Ref.	pag.	Ref.	pag.	Ref.	pag.	Ref.	pag.	Ref.	pag.	Ref.	pag.
PACP25050	193	PMO1012	301	PUOXBITC25	227	REIN3206	113	RENO6016	112	SCEM101640	202
PACP29050	193	PRX01	291	PUOXBITC30	227	REIN3208	113	RENO6018	112	SCER302525	203
PACP29060	193	PS1655060	147	PUOXBITC40	227	REIN3212	113	RENO6025	112	SCER392822	203
PACP29070	193	PS1655082	147	PUOXBITL10	227	REIN3215	113	RESX300	291	SCGA100404	201
PACP34030	193	PS1655098	147	PUOXBITL15	227	REIN4008	113	RESX550	291	SCGEZ704025	203
PACP34040	193	PS1655115	147	PUOXBITL20	227	REIN4010	113	RETE5220	301	SCLCZ354030	203
PACP34050	193	PS1955195	147	PUOXBITL25	227	REIN4012	113	RMEX01	116	SCLD040606	201
PACP34060	193	PS1955230	147	PUOXBITL30	227	REIN4016	113	RMMA01	116	SCLD060806	201
PACP34070	193	PSS5060	147	PUOXBITL40	227	REIN4810	113	RMPA01	116	SCMX020214	203
PACP34080	193	PSS5082	147	PUPHC01	226	REIN4812	113	RSA23509	155	SCMX030314	203
PAESM04	107	PSS5098	147	PUPHC02	226	REIN4816	113	RSA24213	155	SCMX040415	203
PAESM05	107	PSS5115	147	PUPHC03	226	REIN4818	113	RSA24216	155	SCMX050515	203
PAESM06	107	PSS5130	147	PUPHL01	226	REIN4820	113	RSA24219	155	SCMX060618	203
PAESM08	107	PSS5150	147	PUPHL02	226	RENO3206	112	RSA24816	155	SCMX070718	203
PAEXM08	240	PSS5180	147	PUPHL03	226	RENO3208	112	RSA24819	155	SCOB020214	202
PAEXM10	240	PSAA0400	297	PUPI01	88	RENO3208BL	113	RSA24825	155	SCOB030314	202
PAGAM04	107	PSAA2125	297	PUPI02	88	RENO3208NE	114	RSZ3509	154	SCOB040415	202
PAGAM05	107	PSAA3150	297	PUPM014	228	RENO3210	112	RSZ3513	154	SCOB050515	202
PAGAM06	107	PSAAV0150	297	PUPOC01	227	RENO3210BL	113	RSZ3516	154	SCOB060618	202
PAGAM08	107	PSAUN200	297	PUPOC02	227	RENO3210NE	114	RSZ4213	154	SCOB070718	202
PCU0005	128	PSEA601575	297	PUPOC03	227	RENO3212	112	RSZ4216	154	SCOB090920	202
PCU0006	128	PSEA602125	297	PUPOL01	227	RENO3212BL	113	RSZ4219	154	SCOB101020	202
PFA4M0800	316	PSEA603150	297	PUPOL02	227	RENO3212NE	114	RSZ4225	154	SCOB121222	202
PFA4M0810	316	PSEUN060200	297	PUPOL03	227	RENO3214	112	RSZ4232	154	SCOZ151525	202
PFA4M1000	316	PSLI655075	147	PUSC750	86	RENO3216	112	RSZ4813	154	SCPD107530	203
PFZNM0800	316	PSLI655085	147	PUSP750	86	RENO3218	112	RSZ4816	154	SCPD128035	203
PFZNM0810	316	PSLI655105	147	PUTC750	87	RENO4006	112	RSZ4819	154	SCREZ357565	203
PFZNM1000	316	PSLI655130	147	PUTO010	226	RENO4008	112	RSZ4825	154	SCRF070605	201
PGI2718	289	PSLI655150	147	PUTO015	226	RENO4008BL	113	RSZ4832	154	SCRF070705	201
PGI2830	289	PSLI955255	147	PUTO020	226	RENO4008NE	114	RSZ4838	154	SCRF090906	201
PGI3840	289	PSLI955285	147	PUTO025	226	RENO4010	112	RTX01	293	SCRF101009	201
PGSA26	296	PSL55075	147	PUTO030	226	RENO4010BL	113	SACI06080	321	SCRF151505	201
PGX4121	293	PSL55085	147	PUTO040	226	RENO4010NE	114	SAIL06080	320	SCRCG090505	201
PGX4141	293	PSL55105	147	PUTP750	86	RENO4012	112	SALH08100	320	SCRCG090508	201
PGZ2718	289	PSL55130	147	PUTPR750	86	RENO4012BL	113	SALH10120	320	SCR090	292
PGZ2830	289	PSL55150	147	PUZ2718	289	RENO4012NE	114	SALN08100	320	SEACRB280	85
PGZ3840	289	PSL55175	147	PUZ3840	289	RENO4014	112	SALN10120	320	SEACRG280	85
PL35019	124	PSL55200	147	RAFEM145	319	RENO4014BL	113	SATEA0865	321	SIPRB280	84
PL35025	124	PSL55230	147	RAFEM175	319	RENO4014NE	114	SATEA1075	321	SIPRG280	84
PL35035	124	PTBRI0035	204	RAFIN100	318	RENO4016	112	SATEB0860	321	SIPRM280	84
PL35045	124	PTBRI3355	204	RAFRE095	318	RENO4018	112	SATEB1080	321	SIPRN280	84
PL35055	124	PTEM18040	204	RAPES032	319	RENO4020	112	SAWH06070	321	SIPRSB280	84
PL39025	124	PTE1169845	204	RARAY032	319	RENO4025	112	SAWHM06060	321	SIPRST280	84
PL39035	124	PTOB05015	204	RAROI00	319	RENO4030	112	SAWL05080	320	SIPRT280	84
PL39045	124	PTOB06015	204	RATRG095	318	RENO4035	112	SAWZ05080	320	SIUNIB280	84
PL39055	124	PTOB08015	204	RATRI095	318	RENO4806	112	SCAS3317DR	201	SIUNIG280	84
PL42070	124	PTOB10015	204	RECA4008	113	RENO4808	112	SCAS3317IZ	201	SIUNINM280	84
PL42080	124	PTOB12020	204	RECA4010	113	RENO4810	112	SCCDZ402575	202	SIUNIN280	84
PL48090	124	PTTT030716	204	RECA4012	113	RENO4810BL	113	SCCE200404	201	SIUNIT280	84
PL48100	124	PTTT11430	204	RECA4016	113	RENO4810NE	114	SCCI303030	202	SIUNSB280	85
PL48110	124	PTUNI2038	204	RECA4810	113	RENO4812	112	SCCI404040	202	SIUNST280	85
PL48120	124	PTUNI6038	204	RECA4812	113	RENO4812BL	113	SCCI606060	202	SJZ0403	118
PL48130	124	PTUN20060	204	RECA4814	113	RENO4812NE	114	SCED050503	200	SJZ0505	118
PLCAZ4213	125	PTUN20080	204	RECA4816	113	RENO4814	112	SCED060604	200	SJZ0506	118
PLCAZ4216	125	PTUN24060	204	RECA4818	113	RENO4814BL	113	SCED070705	200	SJZ0608	118
PLCAZ4219	125	PTUN24080	204	REFL4012	114	RENO4814NE	114	SCED090904	200	SJZ0810	118
PLCAZ4225	125	PUCA01	88	REFL4014	114	RENO4816	112	SCED090906	200	SJZ0811	118
PLCAZ4232	125	PUCI500	88	REFL4016	114	RENO4816BL	113	SCEDI01009	200	SJZ1013	118
PLCAZ4241	125	PUCUC01	227	REFL4018	114	RENO4816NE	114	SCEI040402	200	SJZ1014	118
PLCAZ4251	125	PUCUC02	227	REFL4020	114	RENO4818	112	SCEI040404	200	SJZ1216	118
PLEP35025	124	PUCUC03	227	REFL4025	114	RENO4820	112	SCEI040406	200	SJZ1220	118
PLEP35035	124	PUCUL01	227	REFL4814	114	RENO4822	112	SCEI050504	200	SJZ1422	118
PLRA3925	125	PUCUL02	227	REFL4816	114	RENO4824	112	SCEI060604	200	SJZ1426	118
PLRA3935	125	PUCUL03	227	REFL4818	114	RENO4826	112	SCEI060606	200	SJZ1630	118
PLRA3945	125	PUEP750	87	REFL4824	114	RENO4828	112	SCEI060608	200	SJZ1634	118
PLRA3955	125	PUF750	87	REFL4830	114	RENO4830	112	SCEI070704	200	SJZ1640	118
PLRA4835	125	PUPF750	87	REFL4835	114	RENO4835	112	SCEI080808	200	SLPC10070	55
PLTR3525	125	PUOXBITC10	227	REFL4840	114	RENO6008	112	SCEI101004	200	SLPC10080	55
PLTR3535	125	PUOXBITC15	227	REFL4845	114	RENO6010	112	SCEI101010	200	SLPC10100	55
PLTR3545	125	PUOXBITC20	227	REFL4850	114	RENO6012	112	SCEM081240	202	SLPC12100	55

Ref.	pag.	Ref.	pag.	Ref.	pag.	Ref.	pag.	Ref.	pag.	Ref.	pag.
SLPC16100	55	SPZ384060	287	T0840340Z	215	T8142045	156	T8235038	158	T9630620Z	217
SLPC16120	55	STR1680	300	T0840406Z	215	T8142050	156	T8239009	158	T9630625Z	217
SLPC18120	55	SUAB0603	307	T0840408Z	215	T8142060	156	T8239013	158	T9630630Z	217
SLPT10070	55	SUAB0607	307	T0840410Z	215	T8142070	156	T8239016	158	T9630640Z	217
SLPT10080	55	SUAB0614	307	T0840412Z	215	T8142080	156	T8239019	158	T9630650Z	217
SLPT10100	55	SUCA0602	307	T0840416Z	215	T8142090	156	T8239022	158	T9630660Z	217
SLPT10110	55	SUCA0604	307	T0840420Z	215	T814213BLE	157	T8239025	158	T9650306Z	217
SLPT12080	55	SUCA0607	307	T0840425Z	215	T814225BLE	157	T8239032	158	T9650308Z	217
SLPT12090	55	SUCA0802	307	T0840435Z	215	T8148009	156	T8239038	158	T9650310Z	217
SLPT12100	55	SUCA0804	307	T0840445Z	215	T8148013	156	T8239045	158	T9650312Z	217
SLPT12120	55	SUCA0807	307	T0840450Z	215	T8148016	156	T8239050	158	T9650316Z	217
SLPT16100	55	SUCA1002	307	T0840460Z	215	T8148019	156	T8242013	158	T9650320Z	217
SLPT16120	55	SUCA1004	307	T0840470Z	215	T8148022	156	T8242016	158	T9650325Z	217
SLPT16140	55	SUCA1007	307	T0840506Z	215	T8148025	156	T8242019	158	T9650408Z	217
SLPT16160	55	SUCA1202	307	T0840508Z	215	T8148032	156	T8242022	158	T9650410Z	217
SLPT18110	55	SUCA1204	307	T0840510Z	215	T8148038	156	T8242025	158	T9650412Z	217
SLPT18120	55	SUCA1207	307	T0840512Z	215	T8148045	156	T8242032	158	T9650416Z	217
SLPT18140	55	SUCA1502	307	T0840516Z	215	T8148050	156	T8242038	158	T9650420Z	217
SLPT18150	55	SUCA1504	307	T0840520Z	215	T8148060	156	T8242045	158	T9650425Z	217
SLPT18170	55	SUCA1507	307	T0840525Z	215	T8148070	156	T8242050	158	T9650430Z	217
SLPT18200	55	SUCA1902	307	T0840530Z	215	T8148080	156	T8242060	158	T9650435Z	217
SLPT24140	55	SUCA1904	307	T0840535Z	215	T8148090	156	T8242070	158	T9650440Z	217
SLPT24170	55	SUCA1907	307	T0840540Z	215	T8148100	156	T8248013	158	T9650450Z	217
SLPT24200	55	SUCA2502	307	T0840545Z	215	T8148110	156	T8248016	158	T9650510Z	217
SLPT24220	55	SUCA2504	307	T0840550Z	215	T8148120	156	T8248019	158	T9650512Z	217
SLPT28170	55	SUCA2507	307	T0840560Z	215	T8155013	156	T8248022	158	T9650516Z	217
SLPT28200	55	SUCLO2	306	T0840608Z	215	T8155016	156	T8248025	158	T9650520Z	217
SLPT28240	55	SUCLO4	306	T0840610Z	215	T8155019	156	T8248032	158	T9650525Z	217
SOPG27	294	SUCL10	306	T0840616Z	215	T8155022	156	T8248038	158	T9650530Z	217
SOPG38	294	SUCL15	306	T0840620Z	215	T8155025	156	T8248045	158	T9650535Z	217
SOPG41	294	SUCU0602	307	T0840625Z	215	T8155032	156	T8248050	158	T9650540Z	217
SOTP2718	290	SUCU0605	307	T0840630Z	215	T8155038	156	T8248060	158	T9650550Z	217
SOTP2830	290	SUCU0606	307	T0840635Z	215	T8155045	156	T8248070	158	T9650560Z	217
SOTP3840	290	SUCU0607	307	T0840640Z	215	T8155050	156	T8255013	158	T9650610Z	217
SOTP4121	294	SUMOM06	306	T0840645Z	215	T8155060	156	T8255016	158	T9650612Z	217
SOTP4141	294	SUMOM08	306	T0840650Z	215	T8155070	156	T8255019	158	T9650616Z	217
SOUO04110	200	SUMOM10	306	T0840660Z	215	T8155080	156	T8255022	158	T9650620Z	217
SOUO06100	200	SUMOM12	306	T8129006	156	T8155090	156	T8255025	158	T9650625Z	217
SOUO07125	200	SUMOP09	306	T8129009	156	T8155100	156	T8255032	158	T9650630Z	217
SOUO08120	200	SUMOP11	306	T8129013	156	T8155110	156	T8255038	158	T9650635Z	217
SOUO10140	200	SUMOP13	306	T8129016	156	T8155120	156	T8255045	158	T9650640Z	217
SOUR30140DR	200	SUSTC47090	129	T8129019	156	T8163016	156	T8255050	158	T9650650Z	217
SOUR30140IZ	200	SUSTC47180	129	T8129022	156	T8163019	156	T8255060	158	T9650660Z	217
SPGH2718	288	SUSTC47240	129	T8129025	156	T8163022	156	T8255070	158	T9850306Z	216
SPGH3840	288	SUSTC47300	129	T8135006	156	T8163025	156	T8263025	158	T9850308Z	216
SPH2718	288	SUSTC47400	129	T8135009	156	T8163032	156	T8263032	158	T9850310Z	216
SPH3840	288	SUVA0602	306	T8135013	156	T8163038	156	T8263038	158	T9850312Z	216
SPRXH4121	290	SUVA0604	306	T8135016	156	T8163045	156	T8263045	158	T9850316Z	216
SPRXV4121	290	SUVA0610	306	T8135019	156	T8163050	156	T8263050	158	T9850320Z	216
SPUX412100	291	SUVA0615	306	T8135025	156	T8163060	156	T8263060	158	T9850325Z	216
SPUX412145	291	SUVA0802	306	T8135032	156	T8163070	156	T8263070	158	T9850330Z	216
SPV2718	287	SUVA0804	306	T813509BLE	157	T8163080	156	T9630410Z	217	T9850406Z	216
SPV3840	287	SUVA0810	306	T8139009	156	T8163090	156	T9630412Z	217	T9850408Z	216
SPX412115	290	SUVA0815	306	T8139013	156	T8163100	156	T9630416Z	217	T9850410Z	216
SPX412130	290	SVCBL	195	T8139016	156	T8163110	156	T9630420Z	217	T9850412Z	216
SPX412145	290	SVCMA	195	T8139019	156	T8163120	156	T9630430Z	217	T9850416Z	216
SPX414110	290	SVNB01	195	T8139022	156	T8229006	158	T9630440Z	217	T9850420Z	216
SPX414115	290	SVNB02	195	T8139025	156	T8229009	158	T9630450Z	217	T9850425Z	216
SPX414130	290	SVNM01	195	T8139032	156	T8229013	158	T9630510Z	217	T9850430Z	216
SPX414145	290	SVNM02	195	T8139038	156	T8229016	158	T9630512Z	217	T9850435Z	216
SPX414160	290	T0840304Z	215	T8139045	156	T8229019	158	T9630516Z	217	T9850440Z	216
SPX414175	290	T0840306Z	215	T8139050	156	T8229022	158	T9630520Z	217	T9850450Z	216
SPZ271820	287	T0840308Z	215	T8142009	156	T8229025	158	T9630525Z	217	T9850506Z	216
SPZ271830	287	T0840310Z	215	T8142013	156	T8235009	158	T9630530Z	217	T9850508Z	216
SPZ384020	287	T0840312Z	215	T8142016	156	T8235013	158	T9630540Z	217	T9850510Z	216
SPZ384025	287	T0840316Z	215	T8142019	156	T8235016	158	T9630550Z	217	T9850512Z	216
SPZ384030	287	T0840320Z	215	T8142022	156	T8235019	158	T9630560Z	217	T9850516Z	216
SPZ384035	287	T0840325Z	215	T8142025	156	T8235022	158	T9630610Z	217	T9850520Z	216
SPZ384040	287	T0840330Z	215	T8142032	156	T8235025	158	T9630612Z	217	T9850525Z	216
SPZ384050	287	T0840335Z	215	T8142038	156	T8235032	158	T9630616Z	217	T9850530Z	216

Ref.	pag.	Ref.	pag.	Ref.	pag.	Ref.	pag.	Ref.	pag.	Ref.	pag.
T9850535Z	216	TAPLAZK	110	TBI2200	180	TCCA08140	95	TECBT80120	171	TEXBP45060	166
T9850540Z	216	TB05030	180	TBI2220	180	TCCAEP5030	95	TECBT80140	171	TEXBP45070	166
T9850545Z	216	TB05040	180	TBI2240	180	TCCAEP6040	95	TECBT80160	171	TEXBP45080	166
T9850550Z	216	TB05050	180	TBI2260	180	TCCC05025	94	TECBT80180	171	TEXBP50025	166
T9850608Z	216	TB05060	180	TBI4100	180	TCCC05030	94	TECBT80200	171	TEXBP50030	166
T9850610Z	216	TB06025	180	TBA206040	181	TCCC05035	94	TECBT80220	171	TEXBP50035	166
T9850612Z	216	TB06030	180	TBA206050	181	TCCC05050	94	TECBT80240	171	TEXBP50040	166
T9850616Z	216	TB06035	180	TBA206060	181	TCCC06035	94	TECBT80260	171	TEXBP50045	166
T9850620Z	216	TB06040	180	TBA206070	181	TCCC06040	94	TECBT80280	171	TEXBP50050	166
T9850625Z	216	TB06045	180	TBA208050	181	TCCC06050	94	TECBT80300	171	TEXBP50060	166
T9850630Z	216	TB06050	180	TBA208060	181	TCCC06060	94	TEGA25	268	TEXBP50070	166
T9850635Z	216	TB06060	180	TBA208070	181	TCCC06070	94	TEGA33	268	TEXBP50080	166
T9850640Z	216	TB06070	180	TBA208080	181	TCCC06080	94	TEGR2530	268	TEXBP50090	166
T9850650Z	216	TB06080	180	TBA210080	181	TCCC08060	94	TEMO25	268	TEXBP50100	166
T9850660Z	216	TB06090	180	TBR06050	181	TCCC08080	94	TEM033	268	TEXBP50110	166
TACB166025	301	TB06100	180	TBR06060	181	TCCC08100	94	TEPE2530	268	TEXBP50120	166
TACN165525	301	TB06110	180	TBR06070	181	TCCC08120	94	TEXA250050	169	TEXBP60040	166
TACOBRI6L6	273	TB06120	180	TBR08050	181	TCCC08140	94	TEXA250060	169	TEXBP60045	166
TACOBRI6L8	273	TB07030	180	TBR08060	181	TCMA05022	66	TEXA250070	169	TEXBP60050	166
TACOBRI6R8	273	TB07040	180	TBR08070	181	TCMA06030	66	TEXABM06	171	TEXBP60060	166
TACOBRI6E6	272	TB07050	180	TBR08080	181	TCMA06040	66	TEXABM08	171	TEXBP60070	166
TACOBRI6E8	272	TB07060	180	TBR10060	181	TCMA06050	66	TEXABM10	171	TEXBP60080	166
TACOL05	99	TB07070	180	TBR10080	181	TCPA24213	159	TEXBP25010	166	TEXBP60090	166
TACOL06	99	TB07080	180	TC2A06060	93	TCPA24222	159	TEXBP25012	166	TEXBP60100	166
TACOL08	99	TB07090	180	TC2A08060	93	TCPA24232	159	TEXBP25016	166	TEXBP60110	166
TACOL10	99	TB07100	180	TC2A08080	93	TCPB4213	159	TEXBP25020	166	TEXBP60120	166
TACOL12	99	TB07120	180	TC2A08100	93	TCPB4222	159	TEXBP25025	166	TEXBT10080	168
TACOLA06	99	TB08030	180	TC2A08120	93	TCPB4232	159	TEXBP30010	166	TEXBT10100	168
TACON04	99	TB08040	180	TC2A10065	93	TCPN4213	159	TEXBP30012	166	TEXBT10120	168
TACON05	99	TB08045	180	TC2A10080	93	TCPN4222	159	TEXBP30015	166	TEXBT10140	168
TACON06	99	TB08050	180	TC2A10100	93	TCPN4232	159	TEXBP30016	166	TEXBT10160	168
TACON07	99	TB08060	180	TC2A10115	93	TCPZ4213	159	TEXBP30020	166	TEXBT10180	168
TACON08	99	TB08070	180	TC2A10135	93	TCPZ4222	159	TEXBP30025	166	TEXBT10200	168
TACON10	99	TB08080	180	TC2A10160	93	TCPZ4232	159	TEXBP30030	166	TEXBT10220	168
TACON12	99	TB08090	180	TC6A08080	93	TCSO14075	71	TEXBP30035	166	TEXBT10240	168
TACON14	99	TB08100	180	TC6A08100	93	TCSO14100	71	TEXBP30040	166	TEXBT30016	168
TACON16	99	TB08110	180	TC6A08120	93	TCSO14130	71	TEXBP30045	166	TEXBT30020	168
TACOP05	100	TB08120	180	TC6A10100	93	TCSO14160	71	TEXBP35010	166	TEXBT30025	168
TACOP06	100	TB08130	180	TC6A10120	93	TCSO16140	71	TEXBP35012	166	TEXBT30030	168
TACOP07	100	TB08140	180	TC6A10140	93	TCSO16160	71	TEXBP35015	166	TEXBT30035	168
TACOP08	100	TB08150	180	TC6A10160	93	TCSO16200	71	TEXBP35016	166	TEXBT30040	168
TACOP09	100	TB08160	180	TC6A10200	93	TCSO16240	71	TEXBP35020	166	TEXBT35012	168
TACOP10	100	TB08180	180	TC6E08080	93	TCSP05027	94	TEXBP35025	166	TEXBT35016	168
TACOP11	100	TB08200	180	TC6E08100	93	TCSP06032	94	TEXBP35030	166	TEXBT35020	168
TACOP12	100	TBI0040	180	TC6E08120	93	TCSP06040	94	TEXBP35035	166	TEXBT35025	168
TACOP14	100	TBI0050	180	TC6E10100	93	TCSPPE05027	94	TEXBP35040	166	TEXBT35030	168
TAEN4213	156	TBI0060	180	TC6E10120	93	TCSPPE06032	94	TEXBP35045	166	TEXBT35035	168
TAEN4216	156	TBI0070	180	TC6E10140	93	TCSPPE06040	94	TEXBP35050	166	TEXBT35040	168
TAEN4219	156	TBI0080	180	TC6E10160	93	TE25050	103	TEXBP40012	166	TEXBT35045	168
TAEN4225	156	TBI0090	180	TC6E10200	93	TE25090	103	TEXBP40015	166	TEXBT35050	168
TAEN4232	156	TBI0100	180	TCA205030	94	TECBT10100	171	TEXBP40016	166	TEXBT40016	168
TAEZ4213	156	TBI0110	180	TCA206040	94	TECBT10120	171	TEXBP40020	166	TEXBT40020	168
TAEZ4216	156	TBI0120	180	TCA206060	94	TECBT10140	171	TEXBP40025	166	TEXBT40025	168
TAEZ4219	156	TBI0130	180	TCA208060	94	TECBT10160	171	TEXBP40030	166	TEXBT40030	168
TAEZ4225	156	TBI0140	180	TCA208080	94	TECBT10180	171	TEXBP40035	166	TEXBT40035	168
TAEZ4232	156	TBI0150	180	TCA208100	94	TECBT10200	171	TEXBP40040	166	TEXBT40040	168
TALA532	65	TBI0160	180	TCCA05025	95	TECBT10220	171	TEXBP40045	166	TEXBT40045	168
TALAM04	65	TBI0180	180	TCCA05030	95	TECBT10240	171	TEXBP40050	166	TEXBT40050	168
TALAM05	65	TBI0200	180	TCCA05035	95	TECBT10260	171	TEXBP40055	166	TEXBT40055	168
TALAM06	65	TBI2060	180	TCCA05050	95	TECBT10280	171	TEXBP40060	166	TEXBT40060	168
TALAM08	65	TBI2070	180	TCCA06035	95	TECBT10300	171	TEXBP40070	166	TEXBT40070	168
TALAM10	65	TBI2080	180	TCCA06040	95	TECBT10320	171	TEXBP40080	166	TEXBT45025	168
TALAM12	65	TBI2090	180	TCCA06050	95	TECBT10340	171	TEXBP40085	166	TEXBT45030	168
TAME05030	65	TBI2100	180	TCCA06060	95	TECBT10360	171	TEXBP40090	166	TEXBT45035	168
TAME06032	65	TBI2120	180	TCCA06070	95	TECBT10380	171	TEXBP40095	166	TEXBT45040	168
TAME08038	65	TBI2130	180	TCCA06080	95	TECBT10400	171	TEXBP40100	166	TEXBT45045	168
TAME08060	65	TBI2140	180	TCCA08060	95	TECBT10420	171	TEXBP40105	166	TEXBT45050	168
TAMEI0060	65	TBI2150	180	TCCA08080	95	TECBT10440	171	TEXBP40110	166	TEXBT45055	168
TAPLAME	110	TBI2160	180	TCCA08100	95	TECBT10460	171	TEXBP40115	166	TEXBT45060	168
TAPLANY	110	TBI2180	180	TCCA08120	95	TECBT10480	171	TEXBP40120	166	TEXBT45065	168
						TECBT10500	171	TEXBP40125	166	TEXBT45070	168
						TECBT10520	171	TEXBP40130	166	TEXBT45075	168
						TECBT10540	171	TEXBP40135	166	TEXBT45080	168
						TECBT10560	171	TEXBP40140	166	TEXBT45085	168
						TECBT10580	171	TEXBP40145	166	TEXBT45090	168
						TECBT10600	171	TEXBP40150	166	TEXBT45095	168
						TECBT10620	171	TEXBP40155	166	TEXBT45100	168
						TECBT10640	171	TEXBP40160	166	TEXBT45105	168
						TECBT10660	171	TEXBP40165	166	TEXBT45110	168
						TECBT10680	171	TEXBP40170	166	TEXBT45115	168
						TECBT10700	171	TEXBP40175	166	TEXBT45120	168
						TECBT10720	171	TEXBP40180	166	TEXBT45125	168
						TECBT10740	171	TEXBP40185	166	TEXBT45130	168
						TECBT10760	171	TEXBP40190	166	TEXBT45135	168
						TECBT10780	171	TEXBP40195	166	TEXBT45140	168
						TECBT10800	171	TEXBP40200	166	TEXBT45145	168
						TECBT10820	171	TEXBP40205	166	TEXBT45150	168
						TECBT10840	171	TEXBP40210	166	TEXBT45155	168
						TECBT10860	171	TEXBP40215	166	TEXBT45160	168
						TECBT10880	171	TEXBP40220	166	TEXBT45165	168
						TECBT10900	171	TEXBP40225	166	TEXBT45170	168
						TECBT10920	171	TEXBP40230	166	TEXBT45175	168
						TECBT10940	171	TEXBP40235	166	TEXBT45180	168
						TECBT10960	171	TEXBP40240	166	TEXBT45185	168
						TECBT10980	171	TEXBP40245	166	TEXBT45190	168
						TECBT11000	171	TEXBP40250	166	TEXBT45195	168
						TECBT11020	171	TEXBP40255	166	TEXBT45200	168
						TECBT11040	171	TEXBP40260	166	TEXBT45205	168
						TECBT11060	171	TEXBP40265	166	TEXBT45210	168
						TECBT11080	171	TEXBP40270	166	TEXBT45215	168
						TECBT11100	171	TEXBP40275	166	TEXBT45220	168
						TECBT11120	171	TEXBP40280	166	TEXBT45225	168
						TECBT11140	171	TEXBP40285	166	TEXBT45230	168
						TECBT11160	171	TEXBP40290	166	TEXBT45235	168
						TECBT11180	171	TEXBP40295	166	TEXBT45240	168
						TECBT11200	171	TEXBP40300	166	TEXBT45245	168
						TECBT11220	171	TEXBP40305	166	TEXBT45250	168
						TECBT11240	171	TEXBP40310	166	TEXBT45255	168
						TECBT11260	171	TEXBP40315	166	TEXBT45260	168
						TECBT11280	171	TEXBP40320	166	TEXBT45265	168
						TECBT11300	171	TEXBP40325	166	TEXBT45270	168
						TECBT11320	171	TEXBP40330	166	TEXBT45275	168

Ref.	pag.	Ref.	pag.	Ref.	pag.	Ref.	pag.	Ref.	pag.	Ref.	pag.
TPA250070	179	TPPO60120	174	TPTO35017	178	TRA6080	70	TSGA22	118	VABE4219	142
TPAP352000	299	TPPO60130	174	TPTO35020	178	TRAB070	70	TSGA24	118	VABE4225	142
TPAR251500	299	TPPO60140	174	TPTO35025	178	TRAB090	70	TSGA30	118	VABE4232	142
TPBLANC	54	TPPO60150	174	TPTO35030	178	TRAB110	70	TSGA36	118	VABE4813	142
TPCR042BL	229	TPPO60160	174	TPTO35040	178	TRAB130	70	TUG201006	288	VABE4816	142
TPCR042NE	229	TPPO60180	174	TPTO35050	178	TRAB150	70	TUG201008	288	VABE4819	142
TPCR048BL	229	TPPO60200	174	TPTO40020	178	TRAV0411	115	TUG271808	288	VABE4825	142
TPCR048NE	229	TPPO60220	174	TPTO40025	178	TRAV0513	115	TUG271810	288	VABE4832	142
TPCR055BL	229	TPPOZ25010	176	TPTO40030	178	TRAV0616	115	TUGRA2706	289	VABE4838	142
TPCR055NE	229	TPPOZ25012	176	TPTO40035	178	TRAV0819	115	TUGRA2708	289	VABE5519	142
TPMARRO	54	TPPOZ25016	176	TPTO40040	178	TRAV1021	115	TUGRA3808	289	VABE5522	142
TPPO25010	174	TPPOZ25020	176	TPTO40045	178	TRBL200200	129	TUGRA3810	289	VABE5525	142
TPPO25012	174	TPPOZ25025	176	TPTO40050	178	TRBL300300	129	TUGX08	291	VABE5532	142
TPPO25016	174	TPPOZ30012	176	TPTO40060	178	TRBL400400	129	TUGX10	291	VABE5538	142
TPPO25020	174	TPPOZ30016	176	TPTO40070	178	TRBL500500	129	TUGXMU08	292	VABE5550	142
TPPO25025	174	TPPOZ30020	176	TPTO45030	178	TRBL600600	129	TUGXMU10	292	VABE5563	142
TPPO30012	174	TPPOZ30025	176	TPTO45035	178	TRCA0310	115	TUMAM03	224	VABE6319	142
TPPO30016	174	TPPOZ30030	176	TPTO45040	178	TRCA0410	115	TUMAM04	224	VABE6325	142
TPPO30020	174	TPPOZ30040	176	TPTO45045	178	TRCA0411	115	TUMAM05	224	VABE6332	142
TPPO30025	174	TPPOZ35016	176	TPTO45050	178	TRCA0512	115	TUMAM06	224	VABE6338	142
TPPO30030	174	TPPOZ35020	176	TPTO45060	178	TRCA0515	115	TUMAM08	224	VABE6350	142
TPPO30040	174	TPPOZ35025	176	TPTO45070	178	TRCA0614	115	TUMAM10	224	VABE6363	142
TPPO35016	174	TPPOZ35030	176	TPTO50030	178	TRCA0616	115	TUMAM12	224	VABP3513	153
TPPO35020	174	TPPOZ35035	176	TPTO50035	178	TRCA0816	115	TUMAM14	224	VABP3516	153
TPPO35025	174	TPPOZ35040	176	TPTO50040	178	TRCA0818	115	TUMAM16	224	VABP3519	153
TPPO35030	174	TPPOZ35050	176	TPTO50045	178	TRCAI017	115	TURX08	292	VABP3525	153
TPPO35035	174	TPPOZ40016	176	TPTO50050	178	TRCAI022	115	TURX10	292	VABP3913	153
TPPO35040	174	TPPOZ40020	176	TPTO50060	178	TRCAI223	115	TURX12	292	VABP3916	153
TPPO35050	174	TPPOZ40025	176	TPTO50070	178	TRCR0410	115	TURXA08	292	VABP3919	153
TPPO40016	174	TPPOZ40030	176	TPTO50080	178	TRCR0511	115	TURXA10	292	VABP3925	153
TPPO40020	174	TPPOZ40035	176	TPTO50090	178	TRCR0614	115	TURXA208	292	VABP3938	153
TPPO40025	174	TPPOZ40040	176	TPTO50100	178	TRCR0815	115	TWA06060	47	VABP4213	153
TPPO40030	174	TPPOZ40045	176	TPTO50120	178	TRCR0919	115	TZN812909	157	VABP4216	153
TPPO40035	174	TPPOZ40050	176	TPTO60060	178	TREPVO5050	183	TZN813513	157	VABP4219	153
TPPO40040	174	TPPOZ40060	176	TPTO60070	178	TREPVO7050	183	TZN813516	157	VABP4225	153
TPPO40045	174	TPPOZ40070	176	TPTO60080	178	TREZ05050	183	TZN813519	157	VABP4232	153
TPPO40050	174	TPPOZ45020	176	TPTO60090	178	TREZ07050	183	TZN813525	157	VABP4238	153
TPPO40060	174	TPPOZ45025	176	TPTO60100	178	TRPO30016	179	TZN814216	157	VABP4816	153
TPPO40070	174	TPPOZ45030	176	TPTO60110	178	TRPO30020	179	TZN814219	157	VABP4819	153
TPPO45020	174	TPPOZ45035	176	TPTO60120	178	TRPO35016	179	TZN814225	157	VABP4825	153
TPPO45025	174	TPPOZ45040	176	TPTO60130	178	TRPO35020	179	TZN814232	157	VABP4832	153
TPPO45030	174	TPPOZ45045	176	TPTO60140	178	TRPO35025	179	TZN814238	157	VABP4838	153
TPPO45035	174	TPPOZ45050	176	TPTO60150	178	TRPO35030	179	TZN814816	157	VABP5532	153
TPPO45040	174	TPPOZ45060	176	TPTO60160	178	TRPO35035	179	TZN814819	157	VABR3509	150
TPPO45045	174	TPPOZ45070	176	TPTO60180	178	TRPO40016	179	TZN814822	157	VABR3511	150
TPPO45050	174	TPPOZ45080	176	TPTO60200	178	TRPO40020	179	TZN814825	157	VABR3513	150
TPPO45060	174	TPPOZ50020	176	TPTO60220	178	TRPO40025	179	TZN814838	157	VABR3516	150
TPPO45070	174	TPPOZ50025	176	TPTPADBE	229	TRPO40030	179	TZN814850	157	VABR3519	150
TPPO45080	174	TPPOZ50030	176	TPTPADBL	229	TRPO40035	179	UNCO3220	294	VABR3525	150
TPPO50020	174	TPPOZ50035	176	TPTPADCA	229	TRPO40040	179	UNEX412103	293	VABR3913	150
TPPO50025	174	TPPOZ50040	176	TPTPADCE	229	TRPO40050	179	UNPX412101	293	VABR3916	150
TPPO50030	174	TPPOZ50045	176	TPTPADGR	229	TRPO45016	179	UNPX412102	293	VABR3919	150
TPPO50035	174	TPPOZ50050	176	TPTPADHA	229	TRPO45020	179	UNPX412103	293	VABR3925	150
TPPO50040	174	TPPOZ50060	176	TPTPADNE	229	TRPO45025	179	UNPX412104	293	VABR3932	150
TPPO50045	174	TPPOZ50070	176	TPTPADNO	229	TRPO45030	179	UNTX412104	293	VABR4213	150
TPPO50050	174	TPPOZ50080	176	TPTPADPI	229	TRPO45035	179	VABE144819	143	VABR4216	150
TPPO50060	174	TPPOZ50090	176	TPTPADRO	229	TRPO45040	179	VABE144825	143	VABR4219	150
TPPO50070	174	TPPOZ50100	176	TPTPADSA	229	TRPO45045	179	VABE164819	143	VABR4222	150
TPPO50080	174	TPPOZ50120	176	TRI3200200	129	TRPO50020	179	VABE165522	143	VABR4225	150
TPPO50090	174	TPPOZ60040	176	TRI3300300	129	TRPO50030	179	VABE165525	143	VABR4232	150
TPPO50100	174	TPPOZ60050	176	TRI3400400	129	TRPO50040	179	VABE165532	143	VABR4238	150
TPPO50120	174	TPPOZ60060	176	TRI3500500	129	TRPO50050	179	VABE165538	143	VABR4250	150
TPPO60040	174	TPPOZ60070	176	TRI3600600	129	TRPXS412515	299	VABE165550	143	VABR4813	150
TPPO60050	174	TPPOZ60080	176	TRI5200200	129	TSGA06	118	VABE166325	143	VABR4816	150
TPPO60060	174	TPPOZ60090	176	TRI5300300	129	TSGA08	118	VABE166332	143	VABR4819	150
TPPO60070	174	TPPOZ60100	176	TRI5400400	129	TSGA10	118	VABE166338	143	VABR4822	150
TPPO60080	174	TPPOZ60110	176	TRI5500500	129	TSGA12	118	VABE3509	142	VABR4825	150
TPPO60090	174	TPTO30025	178	TRI5600600	129	TSGA14	118	VABE3513	142	VABR4832	150
TPPO60100	174	TPTO30030	178	TRA6050	70	TSGA16	118	VABE4213	142	VABR4838	150
TPPO60110	174	TPTO35015	178	TRA6060	70	TSGA20	118	VABE4216	142	VABR4845	150

Ref.	pag.	Ref.	pag.	Ref.	pag.	Ref.	pag.	Ref.	pag.	Ref.	pag.
VABR4850	150	VALRO14025	189	VD603905020	214	VD93106030	211	VD93312080	209	VINVZ7070	181
VABR4860	150	VALRO16030	189	VD603905030	214	VD93106040	211	VD933104010	210	VMAE0630	311
VABR4880	150	VALRO17040	189	VD603905040	214	VD93106050	211	VD933104016	210	VMAE0825	311
VABR5532	150	VALRO18040	189	VD603905050	214	VD93106060	211	VD933104020	210	VMAE1030	311
VACHA08C	61	VALRO18050	189	VD603906016	214	VD93106070	211	VD933104030	210	VMAR0420	312
VACHAI0C	61	VALRO19050	189	VD603906020	214	VD93108030	211	VD933104040	210	VMAR0630	312
VACHG08C	60	VALRO19060	189	VD603906030	214	VD93108040	211	VD933105010	210	VMAR0830	312
VACHG10C	60	VALRO19070	189	VD603906040	214	VD93108050	211	VD933105016	210	VMAR1030	312
VACHT08C	57	VALRO20060	189	VD603906050	214	VD93108060	211	VD933105020	210	VMI08075	45
VACHT08L	57	VALRO20070	189	VD603906060	214	VD93108070	211	VD933105030	210	VMI08090	45
VACHT10C	57	VALRO20080	189	VD603906070	214	VD93108080	211	VD933105040	210	VMI10070	45
VACHT10L	57	VALRO21080	189	VD603906080	214	VD93110040	211	VD933105050	210	VMI10090	45
VACHT12C	57	VALRO21090	189	VD603908025	214	VD93110050	211	VD933106010	210	VMI10120	45
VACHT12L	57	VALRO22100	189	VD603908030	214	VD93110060	211	VD933106016	210	VMI12110	45
VACHT16C	57	VALRO22110	189	VD603908040	214	VD93110070	211	VD933106020	210	VMI4408075	44
VACHTA208C	57	VALRO22120	189	VD603908050	214	VD93110080	211	VD933106025	210	VMI4410090	44
VACHTA208L	57	VALRO23130	189	VD603908060	214	VD93112050	211	VD933106030	210	VMI4412110	44
VACHTA210C	57	VALROBI16030	189	VD603908070	214	VD93112060	211	VD933106040	210	VMPPF050	206
VACHTA210L	57	VALROBI7040	189	VD603908080	214	VD93112070	211	VD933106050	210	VPACC15015	193
VACHTA212C	57	VALROBI8050	189	VD603908090	214	VD93112080	211	VD933108016	210	VPACC15020	193
VACHTA212L	57	VALROBI9060	189	VD603908100	214	VD93304008	209	VD933108020	210	VPACC15025	193
VALHA14025	191	VAM06060	47	VD603910025	214	VD93304010	209	VD933108025	210	VPACC20025	193
VALHA16030	191	VAM08075	47	VD603910030	214	VD93304012	209	VD933108030	210	VPACC20030	193
VALHA17040	191	VAM08090	47	VD603910040	214	VD93304016	209	VD933108040	210	VPACC20035	193
VALHA18040	191	VAM10070	47	VD603910050	214	VD93304020	209	VD933108050	210	VPACC20040	193
VALHA18050	191	VAM10090	47	VD603910060	214	VD93304025	209	VD933108060	210	VPACC20045	193
VALHA19050	191	VAM10120	47	VD603910070	214	VD93304030	209	VD933110020	210	VPACC20050	193
VALHA19060	191	VAM12090	47	VD603910080	214	VD93304040	209	VD933110030	210	VPAESM04	107
VALHA19070	191	VAM12110	47	VD902103	222	VD93304050	209	VD933110040	210	VPAESM05	107
VALHA20050	191	VARANE14	148	VD902104	222	VD93304060	209	VD933110050	210	VPAESM06	107
VALHA20060	191	VARANE16	148	VD902105	222	VD93305010	209	VD933110060	210	VPAGAM04	107
VALHA20070	191	VARANE18	148	VD902106	222	VD93305012	209	VD93403	218	VPAGAM05	107
VALHA20080	191	VARANE25	148	VD902108	222	VD93305016	209	VD93404	218	VPAGAM06	107
VALHA21070	191	VBAESM04	106	VD902110	222	VD93305020	209	VD93405	218	VPL35025	124
VALHA21080	191	VBAESM05	106	VD902112	222	VD93305025	209	VD93406	218	VPL35035	124
VALHA21090	191	VBAESM06	106	VD90211M04	222	VD93305030	209	VD93408	218	VPL35045	124
VALHA21100	191	VBAGAM04	106	VD90211M05	222	VD93305040	209	VD93410	218	VRECA4010	113
VALHA22110	191	VBAGAM05	106	VD90211M06	222	VD93305050	209	VD93412	218	VRECA4012	113
VALHA22120	191	VBAGAM06	106	VD90211M08	222	VD93305060	209	VD9341M04	218	VRECA4016	113
VALHA23130	191	VCABA004	106	VD90211M10	222	VD93305070	209	VD9341M05	218	VRECA4810	113
VALHAB16030	191	VCABA005	106	VD91204010	213	VD93306016	209	VD9341M06	218	VRECA4812	113
VALHAB17040	191	VCABA006	106	VD91204012	213	VD93306020	209	VD9341M08	218	VRECA4814	113
VALHAB18050	191	VCAPA004	107	VD91204020	213	VD93306025	209	VD9341M10	218	VRECA4816	113
VALHAB19060	191	VCAPA005	107	VD91204030	213	VD93306030	209	VD9851M04	219	VRECA4818	113
VALHC14025	190	VCAPA006	107	VD91204040	213	VD93306040	209	VD9851M05	219	VREFL4835	114
VALHC16030	190	VCFBL	194	VD91204050	213	VD93306050	209	VD9851M06	219	VRENO3206	112
VALHC17040	190	VDI2503	221	VD91205010	213	VD93306060	209	VD9851M08	219	VRENO3208	112
VALHC18040	190	VDI2504	221	VD91205012	213	VD93306070	209	VD9851M10	219	VRENO3210	112
VALHC18050	190	VDI2505	221	VD91205016	213	VD93308016	209	VDZ98503	219	VRENO3212	112
VALHC19050	190	VDI2506	221	VD91205020	213	VD93308020	209	VDZ98504	219	VRENO3214	112
VALHC19060	190	VDI2508	221	VD91205025	213	VD93308025	209	VDZ98505	219	VRENO3218	112
VALHC19070	190	VDI2510	221	VD91205030	213	VD93308030	209	VDZ98506	219	VRENO4006	112
VALHC20050	190	VDI2512	221	VD91205040	213	VD93308040	209	VDZ98508	219	VRENO4008	112
VALHC20060	190	VDI251M04	221	VD91205050	213	VD93308050	209	VDZ98510	219	VRENO4010	112
VALHC20070	190	VDI251M05	221	VD91206010	213	VD93308060	209	VDZ98512	219	VRENO4012	112
VALHC20080	190	VDI251M06	221	VD91206012	213	VD93308070	209	VGMZ10016	194	VRENO4014	112
VALHC21070	190	VDI251M08	221	VD91206016	213	VD93308080	209	VGMZ15026	194	VRENO4016	112
VALHC21080	190	VDI251M10	221	VD91206020	213	VD93308100	209	VGMZ19035	194	VRENO4018	112
VALHC21090	190	VDI2704	223	VD91206025	213	VD93310020	209	VHENOM06	64	VRENO4020	112
VALHC21100	190	VDI2705	223	VD91206030	213	VD93310030	209	VHENOM08	64	VRENO4808	112
VALHC22110	190	VDI2706	223	VD91206040	213	VD93310040	209	VINCO432	108	VRENO4810	112
VALHC22120	190	VDI2708	223	VD91206050	213	VD93310050	209	VINCO438	108	VRENO4812	112
VALHC23130	190	VDI2710	223	VD91206060	213	VD93310060	209	VINCO446	108	VRENO4814	112
VALRE25020	188	VDI2712	223	VD91208010	213	VD93310070	209	VINCO537	108	VRENO4816	112
VALRE25030	188	VDI58704	220	VD91208016	213	VD93310080	209	VINCO552	108	VRENO4818	112
VALRE35040	188	VDI58705	220	VD91208020	213	VD93312030	209	VINCO637	108	VRENO4820	112
VALRE35050	188	VDI58706	220	VD91208030	213	VD93312040	209	VINCO652	108	VRENO4822	112
VALRE40060	188	VDI58708	220	VD91208040	213	VD93312050	209	VINVN7060	182	VRENO4824	112
VALRE40070	188	VDI58710	220	VD91208050	213	VD93312060	209	VINVN7070	182	VRENO4830	112
VALRE40080	188	VDI58712	220	VD91208060	213	VD93312070	209	VINVZ7060	181	VRENO4835	112

Ref.	pag.	Ref.	pag.	Ref.	pag.	Ref.	pag.	Ref.	pag.	Ref.	pag.
VRSE06020	311	VT9650410Z	217	VTCCA06040	95	VTEXZP45050	167	VTppo35050	175	VTREZ07050	183
VRSE06030	311	VT9650416Z	217	VTCCA06050	95	VTEXZP45060	167	VTppo40016	175	VTUMAM03	224
VRSE08020	311	VT9650420Z	217	VTCCA06060	95	VTEXZP45070	167	VTppo40020	175	VTUMAM04	224
VRSE08030	311	VT9650425Z	217	VTCCA06070	95	VTEXZP50030	167	VTppo40025	175	VTUMAM05	224
VRSE10030	311	VT9650430Z	217	VTCCA08060	95	VTEXZP50035	167	VTppo40030	175	VTUMAM06	224
VRSE12030	311	VT9650510Z	217	VTCCA08080	95	VTEXZP50040	167	VTppo40035	175	VTUMAM08	224
VSVCL	195	VT9650516Z	217	VTEXA250050	169	VTEXZP50045	167	VTppo40040	175	VTUMAM10	224
VSVCLMA	195	VT9650520Z	217	VTEXA250060	169	VTEXZP50050	167	VTppo40045	175	VTUMAM12	224
VSVNB01	195	VT9650530Z	217	VTEXA250070	169	VTEXZP50060	167	VTppo40050	175	ZP06C40	66
VSVNB02	195	VT9650540Z	217	VTEXBP30016	166	VTEXZP50070	167	VTppo40060	175	ZP08C15	66
VSVNM01	195	VT9650610Z	217	VTEXBP30020	166	VTEXZP50080	167	VTppo45030	175	ZP08C45	66
VSVNM02	195	VT9650616Z	217	VTEXBP30025	166	VTEXZP60050	167	VTppo45035	175	ZPI0C50	66
VT8135009	157	VT9650620Z	217	VTEXBP30030	166	VTEXZP60060	167	VTppo45040	175	ZPI0C80	66
VT8135013	157	VT9650630Z	217	VTEXBP30040	166	VTEXZP60070	167	VTppo45045	175	ZPI2C15	66
VT8135016	157	VT9850306Z	216	VTEXBP35016	166	VTEXZP60080	167	VTppo45050	175	ZPI2C65	66
VT8135019	157	VT9850310Z	216	VTEXBP35020	166	VTNUXA08080	91	VTppo45060	175	ZT06L10	66
VT8135025	157	VT9850316Z	216	VTEXBP35025	166	VTNUXA08100	91	VTppo45070	175	ZT06L30	66
VT8139009	157	VT9850320Z	216	VTEXBP35030	166	VTNUXA10080	91	VTppo50030	175	ZT08L15	66
VT8139013	157	VT9850330Z	216	VTEXBP35035	166	VTNUXA10100	91	VTppo50035	175	ZT08L35	66
VT8139016	157	VT9850406Z	216	VTEXBP35040	166	VTNUXE08080	91	VTppo50040	175	ZT08L45	66
VT8139019	157	VT9850408Z	216	VTEXBP35050	166	VTNUXE08100	91	VTppo50050	175	ZT10L10	66
VT8139022	157	VT9850410Z	216	VTEXBP40025	166	VTNUXE10080	91	VTppo50060	175	ZT10L30	66
VT8139025	157	VT9850416Z	216	VTEXBP40030	166	VTNUXE10100	91	VTppo50070	175	ZT10L50	66
VT8142009	157	VT9850420Z	216	VTEXBP40035	166	VTPOZ30025	177	VTppo50080	175	ZT10L80	66
VT8142013	157	VT9850506Z	216	VTEXBP40040	166	VTPOZ30030	177	VTppo50090	175	ZT12L15	66
VT8142016	157	VT9850510Z	216	VTEXBP40045	166	VTPOZ35016	177	VTppo60040	175	ZT12L45	66
VT8142019	157	VT9850512Z	216	VTEXBP40050	166	VTPOZ35020	177	VTppo60050	175	ZT12L65	66
VT8142022	157	VT9850516Z	216	VTEXBP40060	166	VTPOZ35025	177	VTppo60060	175		
VT8142025	157	VT9850520Z	216	VTEXBP45030	166	VTPOZ35030	177	VTppo60070	175		
VT8142032	157	VT9850530Z	216	VTEXBP45035	166	VTPOZ35035	177	VTppo60080	175		
VT8142038	157	VT9850540Z	216	VTEXBP45040	166	VTPOZ35040	177	VTppots05	97		
VT8142050	157	VT9850550Z	216	VTEXBP45045	166	VTPOZ35050	177	VTppots06	97		
VT8148009	157	VT9850610Z	216	VTEXBP45050	166	VTPOZ40016	177	VTppots08	97		
VT8148013	157	VT9850612Z	216	VTEXBP45060	166	VTPOZ40020	177	VTpto30025	178		
VT8148016	157	VT9850616Z	216	VTEXBP45070	166	VTPOZ40025	177	VTpto30030	178		
VT8148019	157	VT9850620Z	216	VTEXBP50030	166	VTPOZ40030	177	VTpto35015	178		
VT8148025	157	VT9850630Z	216	VTEXBP50035	166	VTPOZ40035	177	VTpto35020	178		
VT8148032	157	VT9850640Z	216	VTEXBP50040	166	VTPOZ40040	177	VTpto35025	178		
VT8148038	157	VT9850650Z	216	VTEXBP50050	166	VTPOZ40045	177	VTpto35030	178		
VT8148045	157	VT9850660Z	216	VTEXBP50060	166	VTPOZ40050	177	VTpto35040	178		
VT8148050	157	VTALAM06	65	VTEXBP50070	166	VTPOZ40060	177	VTpto35050	178		
VT8148060	157	VTALAM08	65	VTEXBP50080	166	VTPOZ45030	177	VTpto40020	178		
VT8148070	157	VTALAM10	65	VTEXBP50090	166	VTPOZ45035	177	VTpto40025	178		
VT8148080	157	VTB05040	180	VTEXBP60050	166	VTPOZ45040	177	VTpto40030	178		
VT8155019	157	VTB05050	180	VTEXBP60060	166	VTPOZ45045	177	VTpto40035	178		
VT8155025	157	VTB06040	180	VTEXBP60070	166	VTPOZ45050	177	VTpto40040	178		
VT8155032	157	VTB06050	180	VTEXBP60080	166	VTPOZ45060	177	VTpto40045	178		
VT8155038	157	VTB06060	180	VTEXZP30016	167	VTPOZ45070	177	VTpto40050	178		
VT8235009	158	VTB07050	180	VTEXZP30020	167	VTPOZ50030	177	VTpto40060	178		
VT8235013	158	VTB07060	180	VTEXZP30025	167	VTPOZ50035	177	VTpto45030	178		
VT8235016	158	VTB07070	180	VTEXZP30030	167	VTPOZ50040	177	VTpto45035	178		
VT8235019	158	VTB07080	180	VTEXZP30040	167	VTPOZ50050	177	VTpto45040	178		
VT8235025	158	VTB08050	180	VTEXZP35016	167	VTPOZ50060	177	VTpto45045	178		
VT8239016	158	VTB08060	180	VTEXZP35020	167	VTPOZ50070	177	VTpto45050	178		
VT8239019	158	VTB08070	180	VTEXZP35025	167	VTPOZ50080	177	VTpto45060	178		
VT8239022	158	VTB08080	180	VTEXZP35030	167	VTPOZ50090	177	VTpto45070	178		
VT8239025	158	VTB08090	180	VTEXZP35035	167	VTPOZ60060	177	VTpto50030	178		
VT8242016	158	VTB08100	180	VTEXZP35040	167	VTPOZ60070	177	VTpto50035	178		
VT8242019	158	VTB10070	180	VTEXZP35050	167	VTPOZ60080	177	VTpto50040	178		
VT8242025	158	VTB10080	180	VTEXZP40025	167	VTppo30016	175	VTpto50050	178		
VT8242032	158	VTB10090	180	VTEXZP40030	167	VTppo30020	175	VTpto50060	178		
VT8248019	158	VTB10100	180	VTEXZP40035	167	VTppo30025	175	VTpto50070	178		
VT8248025	158	VTBTS08	97	VTEXZP40040	167	VTppo30030	175	VTpto50080	178		
VT8248032	158	VTBTS10	97	VTEXZP40045	167	VTppo30040	175	VTpto50090	178		
VT8248038	158	VTBTS12	97	VTEXZP40050	167	VTppo35016	175	VTpto60060	178		
VT8255032	158	VTCCA05025	95	VTEXZP40060	167	VTppo35020	175	VTpto60070	178		
VT8255038	158	VTCCA05030	95	VTEXZP45030	167	VTppo35025	175	VTpto60080	178		
VT9650306Z	217	VTCCA05035	95	VTEXZP45035	167	VTppo35030	175	VTREPv05050	183		
VT9650310Z	217	VTCCA05050	95	VTEXZP45040	167	VTppo35035	175	VTREPv07050	183		
VT9650408Z	217	VTCCA06035	95	VTEXZP45045	167	VTppo35040	175	VTREZ05050	183		

A
PERFECT
FIXING

CATINDEX22

INDEX[®]
A PERFECT FIXING

Técnicas Expansivas S.L.

P. I. La Portalada II, C/ Segador, 13
26006 · Logroño (La Rioja) · SPAIN

T. (+34) 941.272.131 · E. info@indexfix.com
www.indexfix.com